

# Assembly Instruction

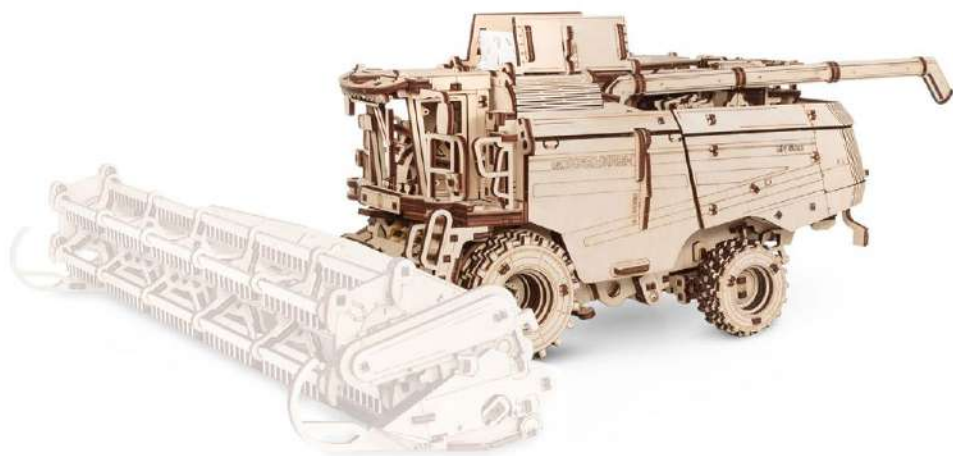

# GRAIN HARVESTING COMBINE GH800

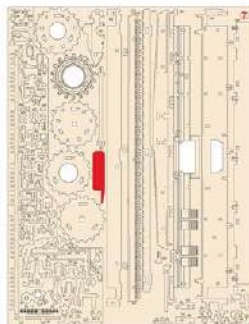

- EN** The ledge is for the squeezing the small details out of the board  
**PL** Wypstę w linijce przeznaczony jest do wyciskania małych detali z arkusza sklejki  
**FR** La proéminence est conçue pour aider à presser et enlever les petits détails de la feuille  
**ES** La repisa es para apretar los pequeños detalles fuera del tablero  
**DE** Der Vorsprung dient dazu, kleine Teile aus den Platten zu drücken  
**RU** Выступ предназначен для выталкивания из листа мелких деталей  
**IT** Le proiezioni riportate sui fogli di istruzione sono utili anche nella fase di smontaggio per estrarre i pezzi  
**CN** 輔助測量尺可幫助取出或鬆取細小零件時使用  
**CZ** Použijte k vytačení malých částí z desky



- EN** Cut it with a razor blade  
**PL** Ciętnij nożem do kaperu  
**FR** Couper avec un cutter  
**ES** Cortar con un bisturí  
**DE** Mit Rasierklinge durchschneiden  
**RU** Обрезать канцелярским ножом  
**IT** Tagliare con un coltello da cancelleria  
**CN** 用刀片切断  
**CZ** Vyřizněte řezákem



- EN** Details should rotate freely  
**PL** Swobodne obracanie  
**FR** Libre rotation  
**ES** Rotación libre  
**DE** Auf freie Rotation achten  
**RU** Свободное вращение  
**IT** Rotazione libera  
**CN** 顺畅地旋转  
**CZ** Části by se měly volně otáčet



- EN** Pay attention  
**PL** Uwaga  
**FR** Faire attention  
**ES** Prestar atención  
**DE** Achtung  
**RU** Уделить внимание  
**IT** Prestare attenzione  
**CN** 请注意  
**CZ** Pozor



- EN** Remove the burrs with sandpaper  
**PL** Usunąć zadziory papierem ściernym  
**FR** Retirer les bavures avec du papier à polir  
**ES** Quitar las rebabas con el papel esmeril  
**DE** Grate mit Schleifpapier entfernen  
**RU** Удалить заусенцы наждачной бумагой  
**IT** Sbavare con carta vetrata  
**CN** 用砂纸去除毛刺  
**CZ** Vyhlaďte smirkových papírem



- EN** Wax it with a candle  
**PL** Posmaruj za pomocą świecy parafinowej  
**FR** Graisser avec une bougie de paraffine  
**ES** Engrasar con ayuda de una vela de parafina  
**DE** Mit einer Kerze wachsen  
**RU** Смазать парафиновой свечой  
**IT** Lubrificare con candela di paraffina  
**CN** 用于蜡涂上蜡油膏  
**CZ** Navoskujte svíčkou



- EN** Glue is recommended  
**PL** Zaleca się użycie kleju  
**FR** Recommandé d'utiliser de la colle  
**ES** Recomendado usar pegamento  
**DE** Es wird empfohlen, Kleber zu verwenden  
**RU** Рекомендуется использовать клей  
**IT** Si consiglia di utilizzare la colla  
**CN** 建议使用胶水  
**CZ** Doporučuje se použít lepidlo

**EN** The manufacturer reserves the right to make changes in the design of the product, not worsening its technical characteristics. Information about the changes made may not be present in this manual.

**PL** Producent zastrzega sobie prawo do zmiany konstrukcji wyrobu bez pogorszenia jego właściwości technicznych. Niniejsza instrukcja może nie zawierać informacji o zmianach.

**FR** Le constructeur se réserve le droit d'apporter des modifications dans la construction du produit à condition si elles ne portent atteinte à ses caractéristiques techniques. Les renseignements sur les modifications apportées peuvent ne pas être dans la présente notice.

**ES** El fabricante se reserva el derecho de introducir modificaciones en la construcción del producto, que no empeoran sus características técnicas. Datos sobre modificaciones introducidas pueden no aparecer en esta instrucción.

**DE** Der Hersteller behält sich das Recht auf Designänderungen, die die technischen Merkmale und Funktionen nicht negativ beeinflussen, vor.

**RU** Производитель оставляет за собой право вносить изменения в конструкцию изделия, не ухудшающие его технические характеристики. Сведения о внесенных изменениях могут отсутствовать в настоящей инструкции.

**IT** Il produttore si riserva il diritto di apportare modifiche al design del prodotto, non peggiorando le sue caratteristiche tecniche. Informazioni sulle modifiche apportate potrebbero non essere presenti in questo manuale.

**CN** 制造商保留对产品 设计更改的权利，一切改良旨在增强产品的技术性能。改良处若未出现在手册中，敬请谅解

**CZ** Výrobce si vyhrazuje právo na takové změny v designu produktu, které nebudou mít za následek zhoršení technických vlastností. Informace o změnách nemusí být v návodu uvedeny.

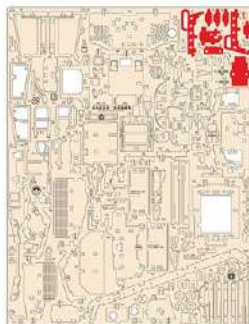
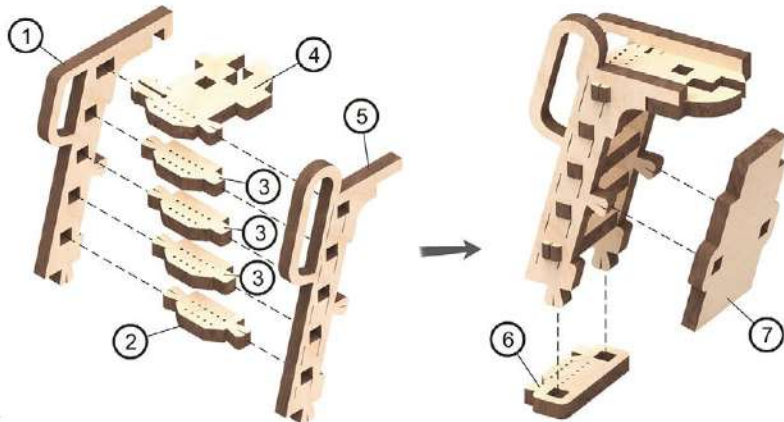

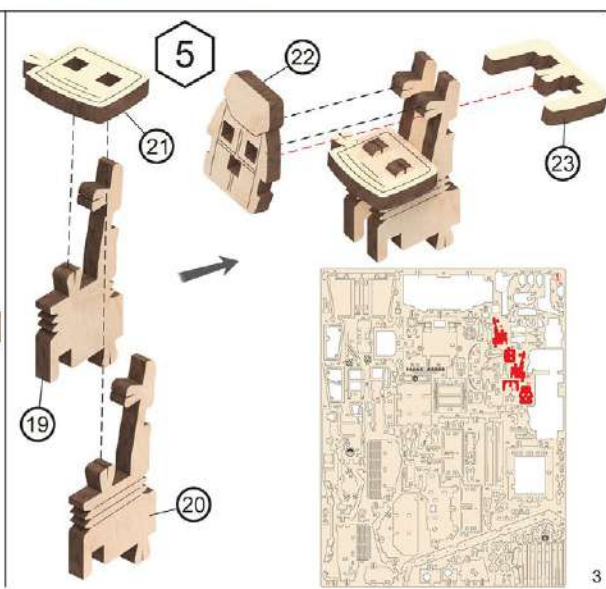
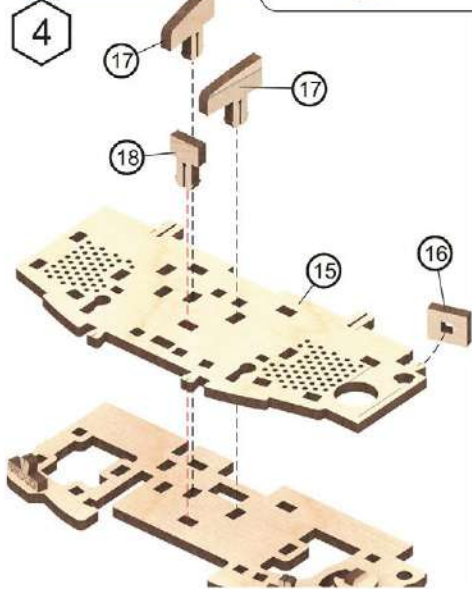
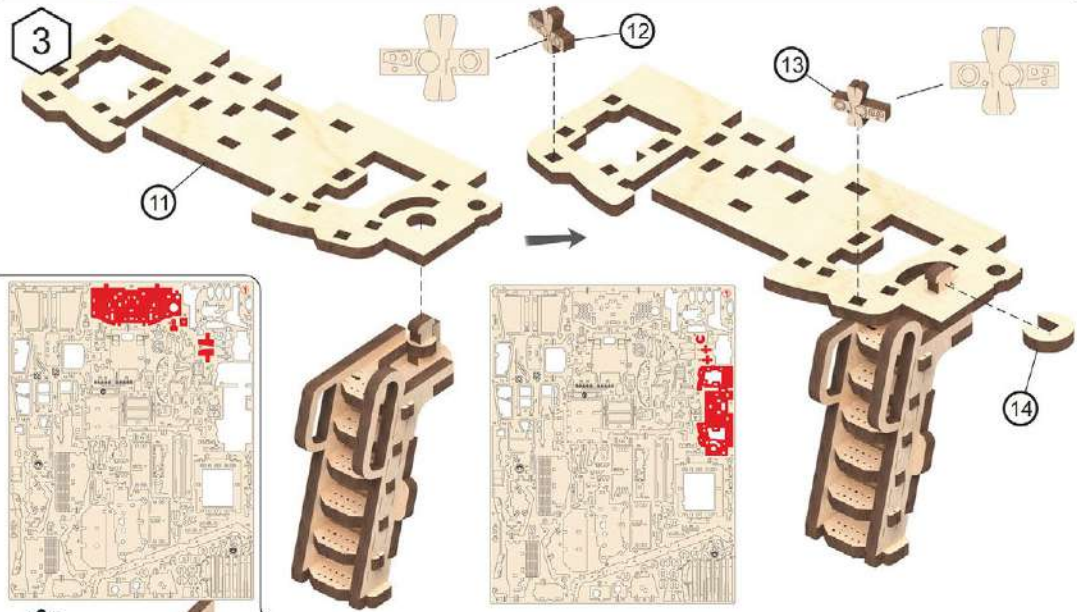
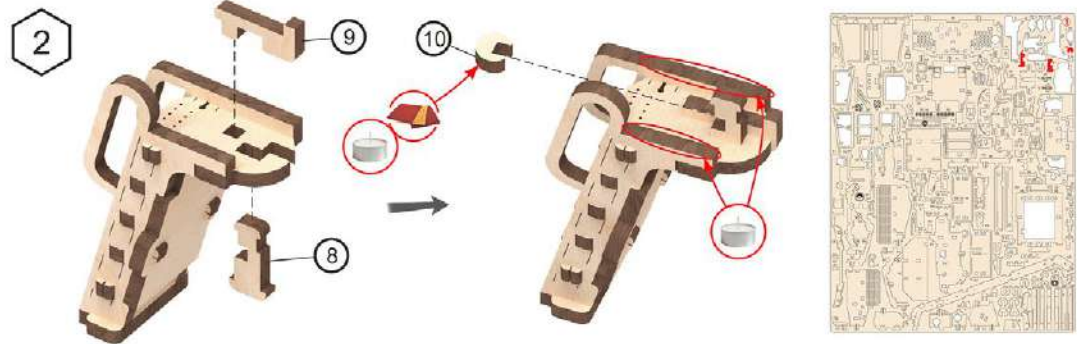

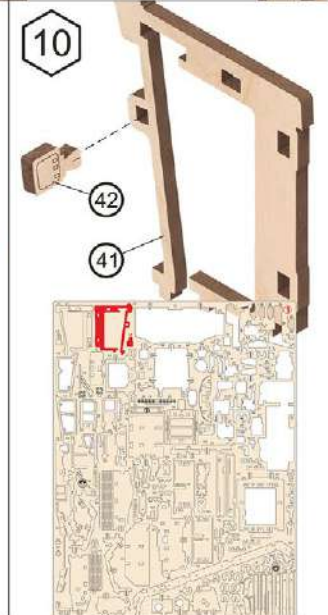
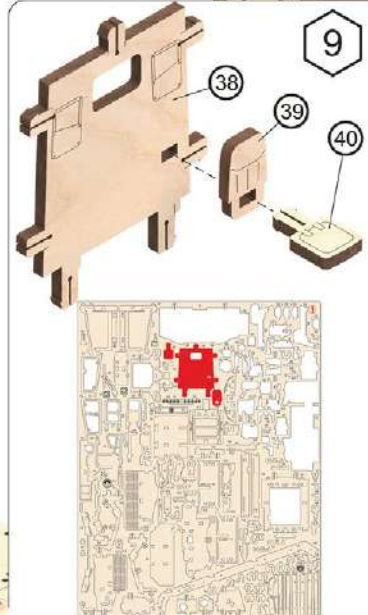
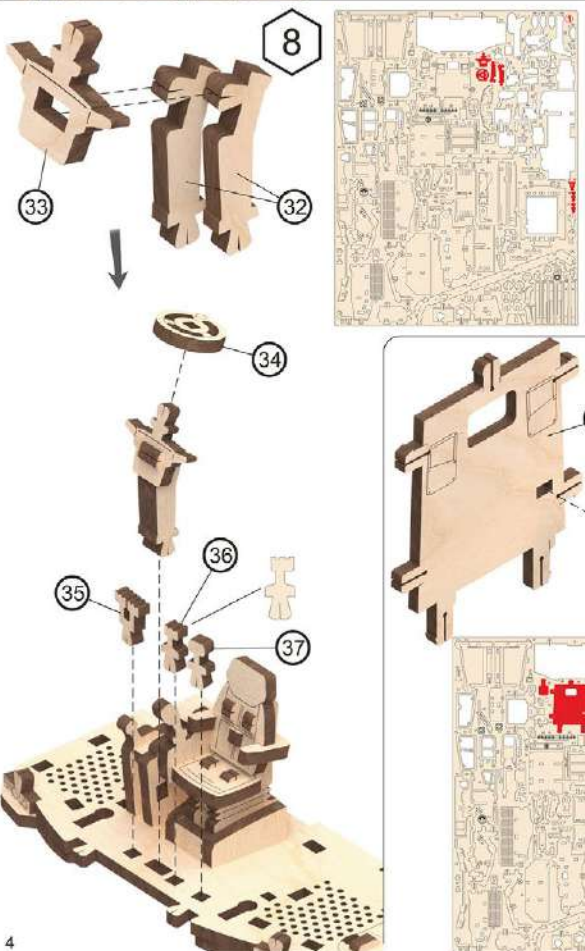
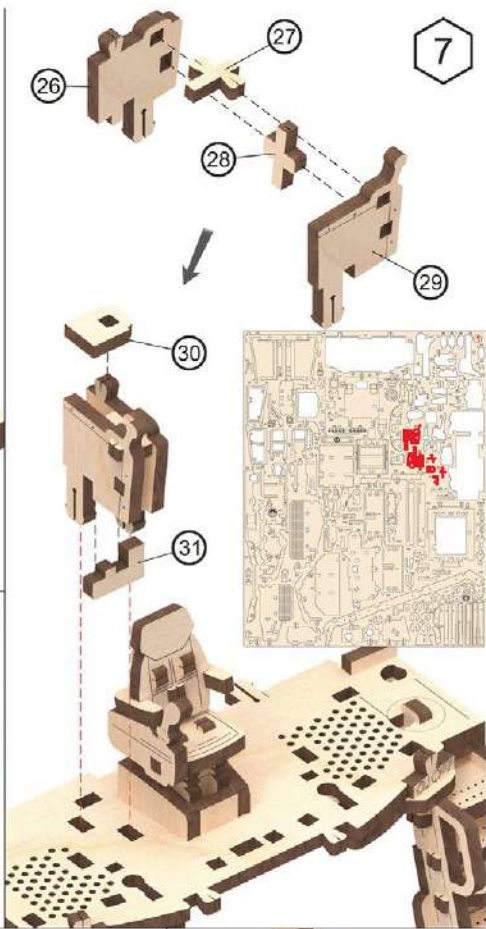
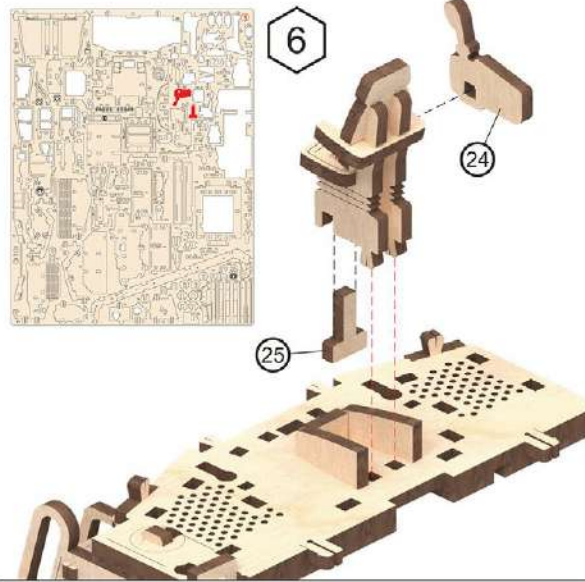

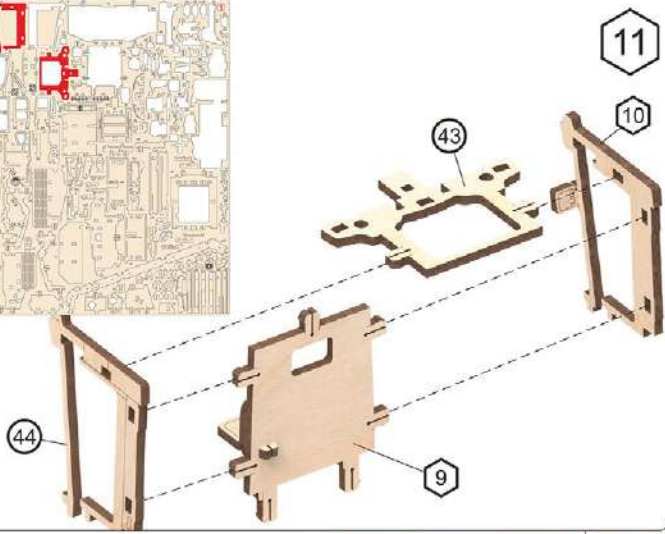
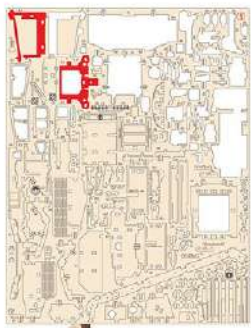

11

12

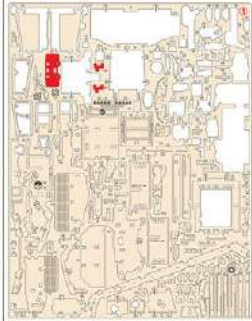
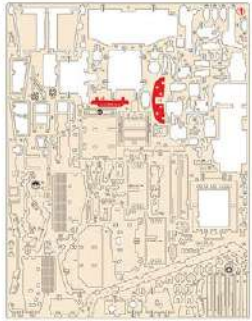
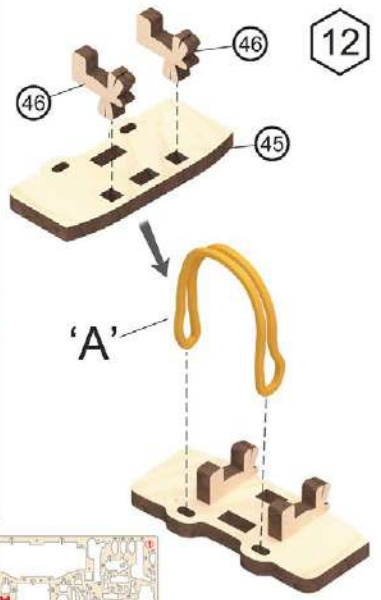

13

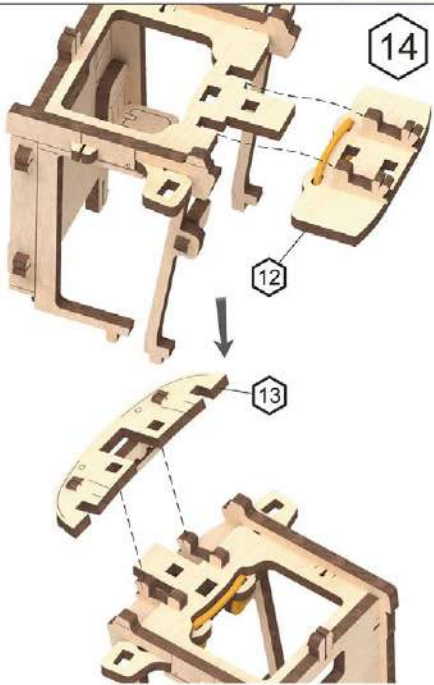
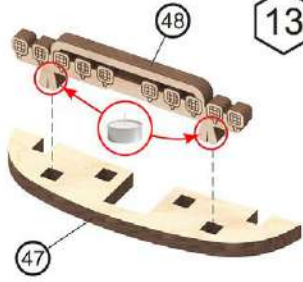

14

15

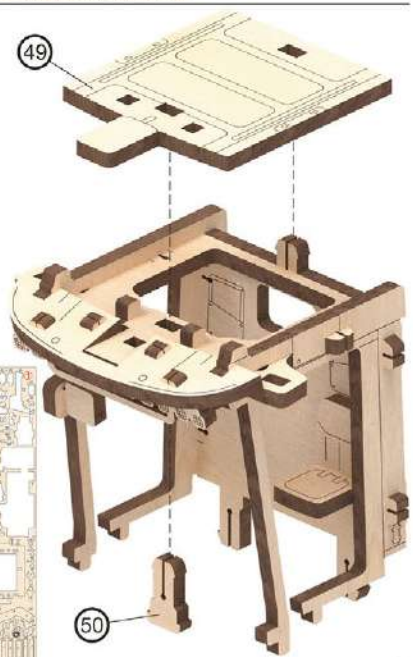
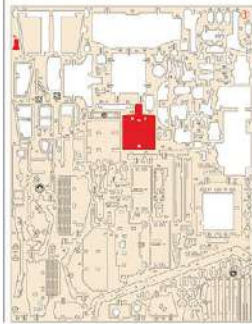



16

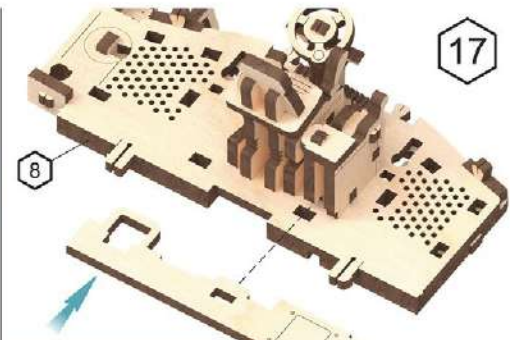
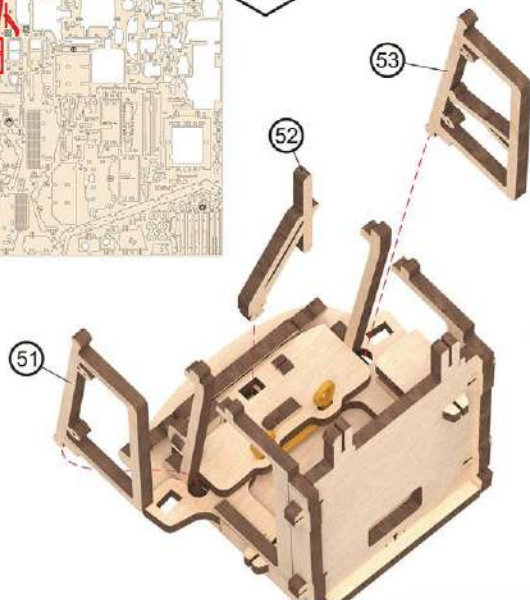

17

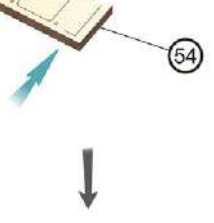

18

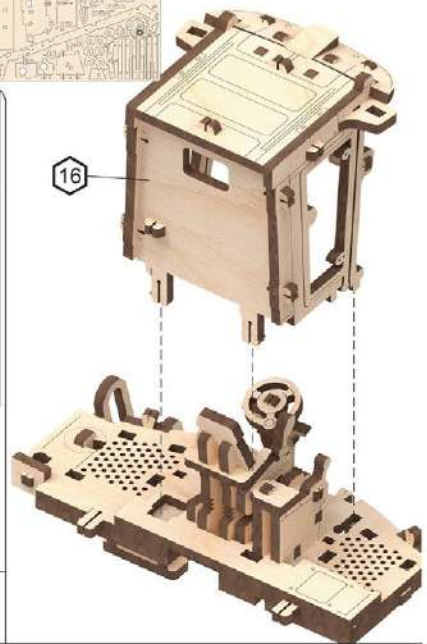
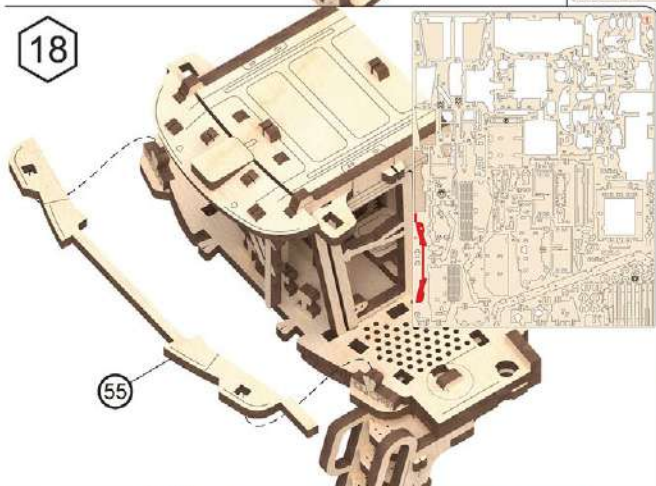

19

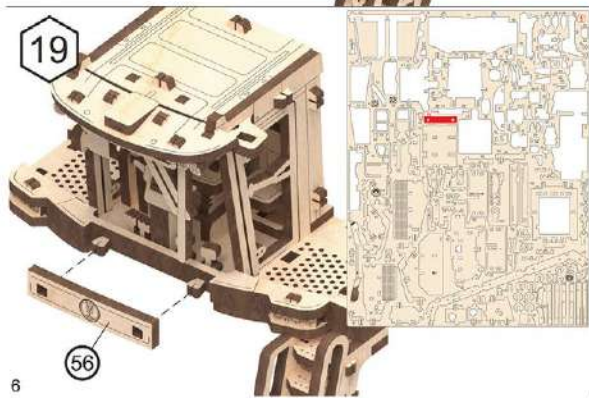

20

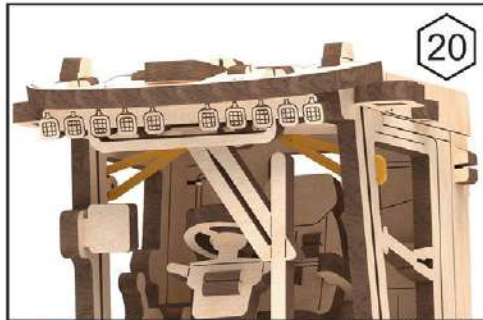

20



21

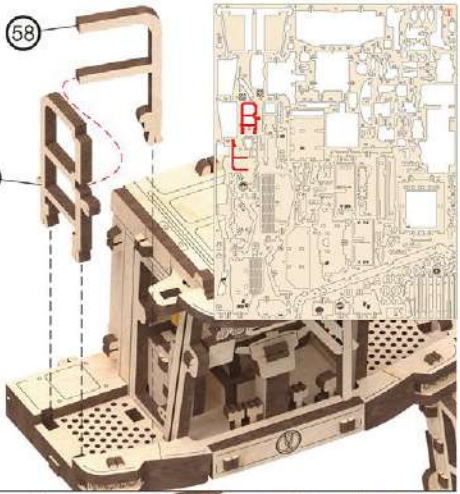

58

57

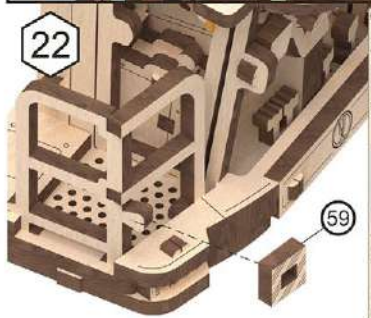

22



59

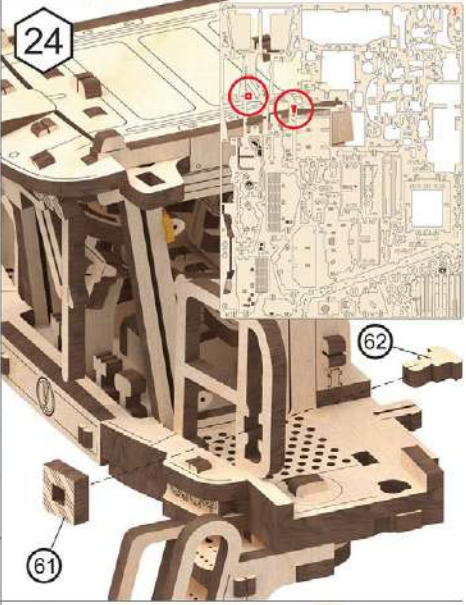

24

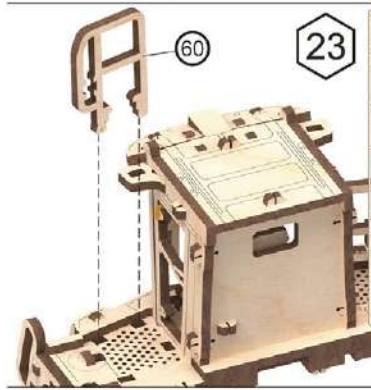

60

23

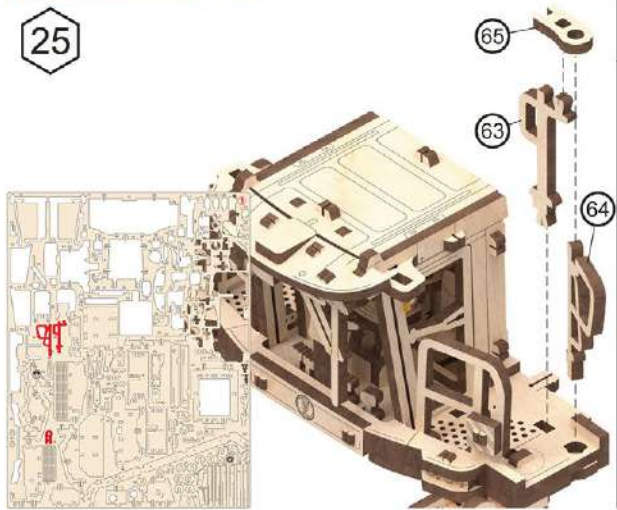

25

65

63

64

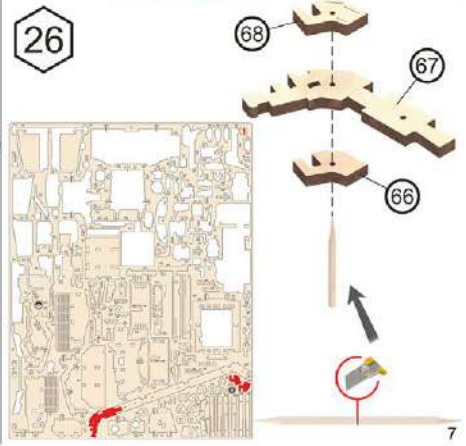

26

68

67

66

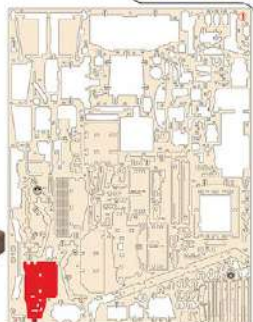
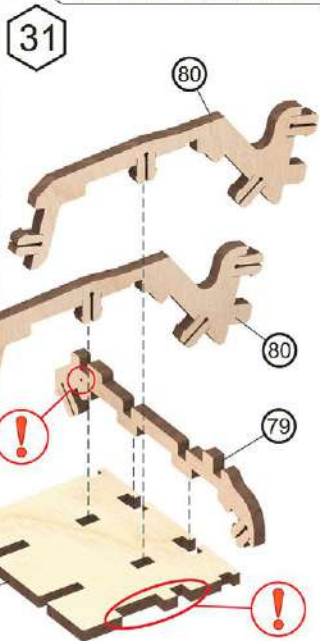
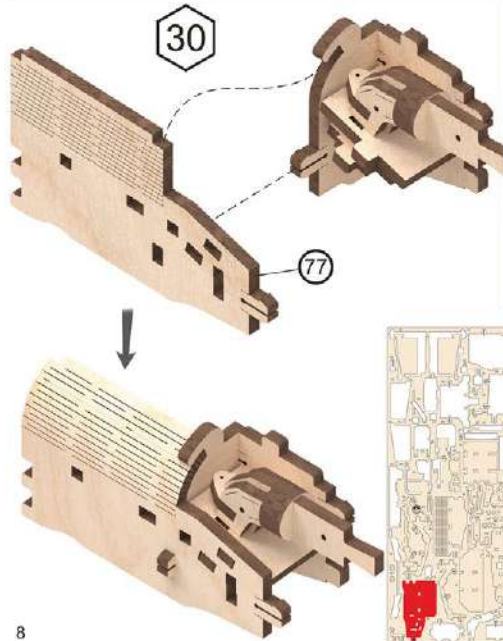
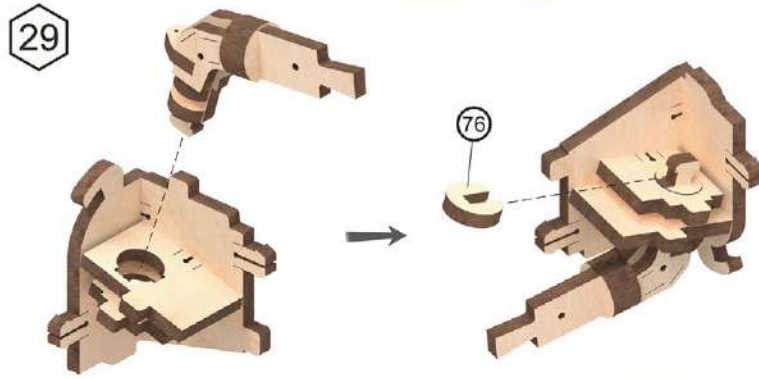
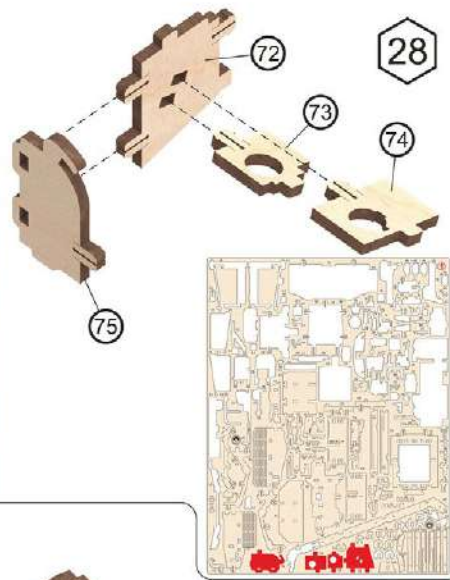
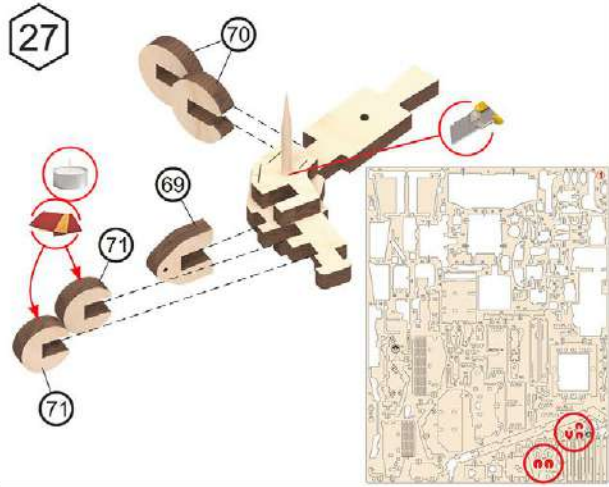



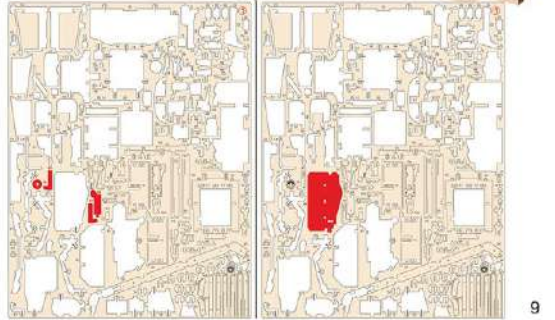
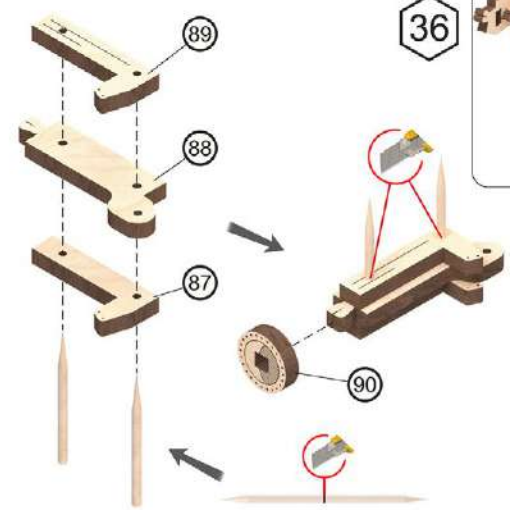
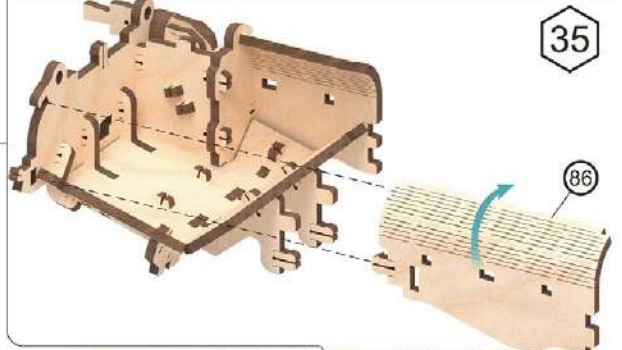
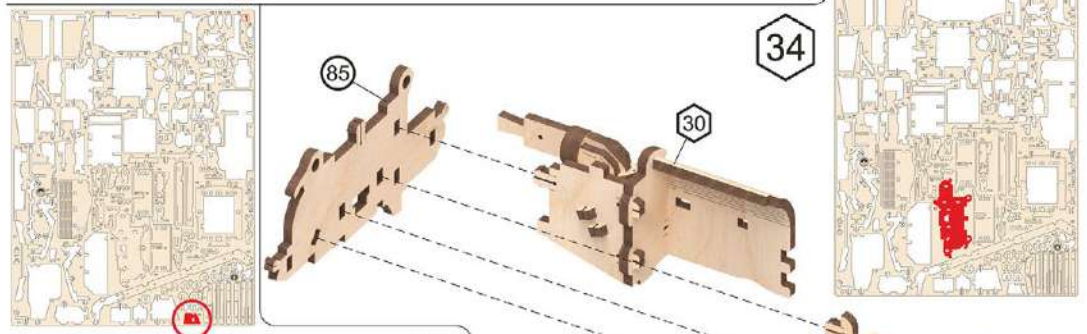
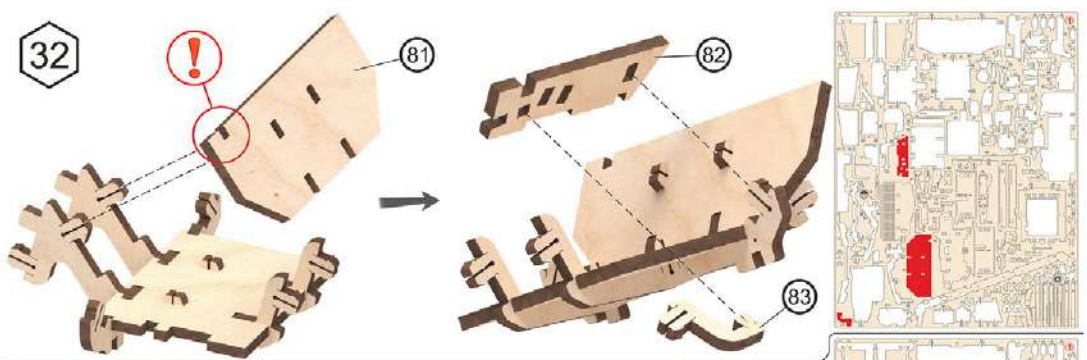

37

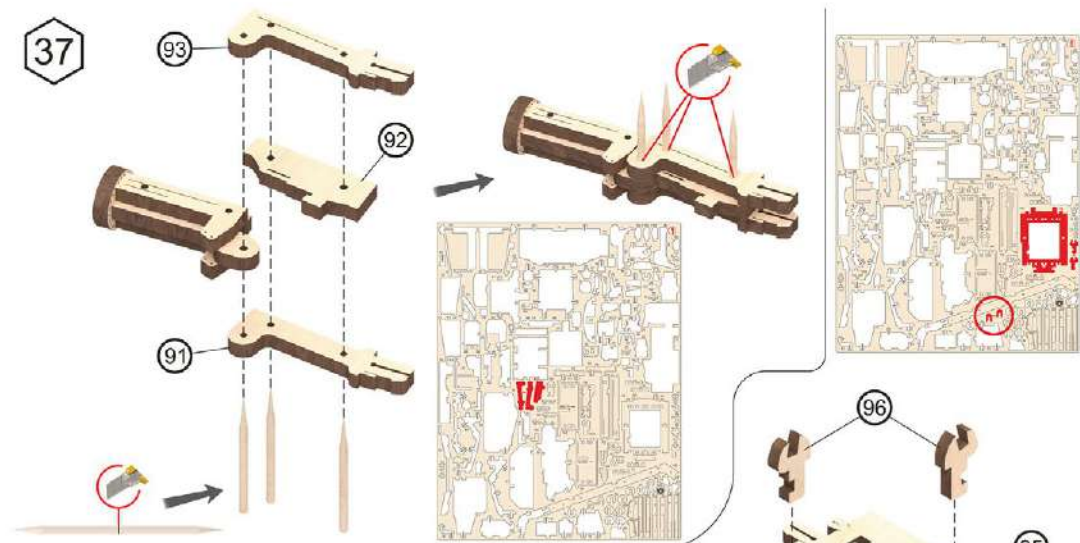

38

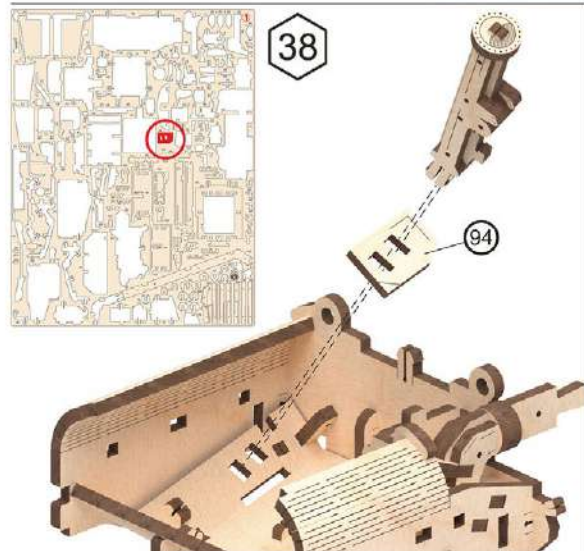

39

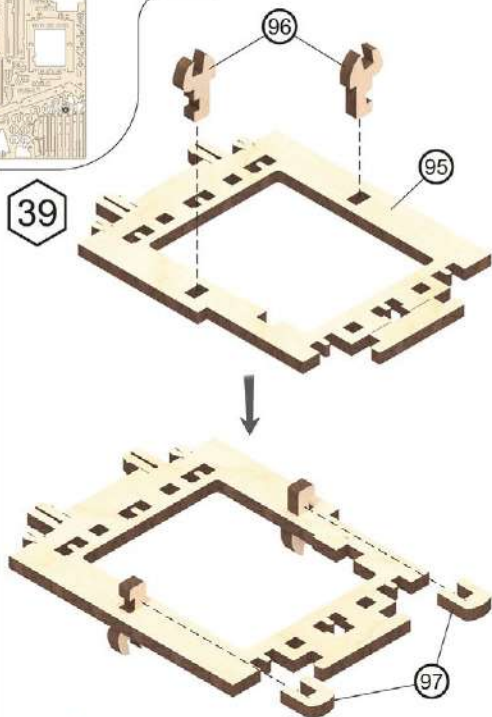

40

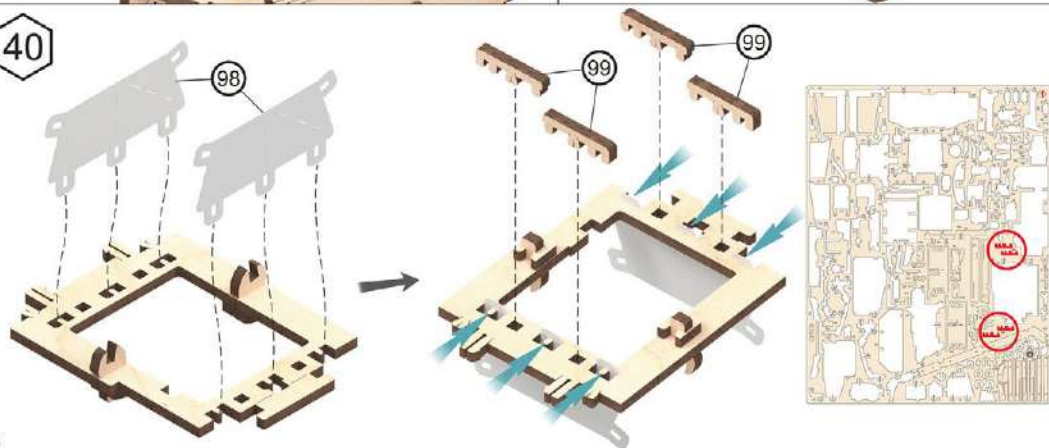

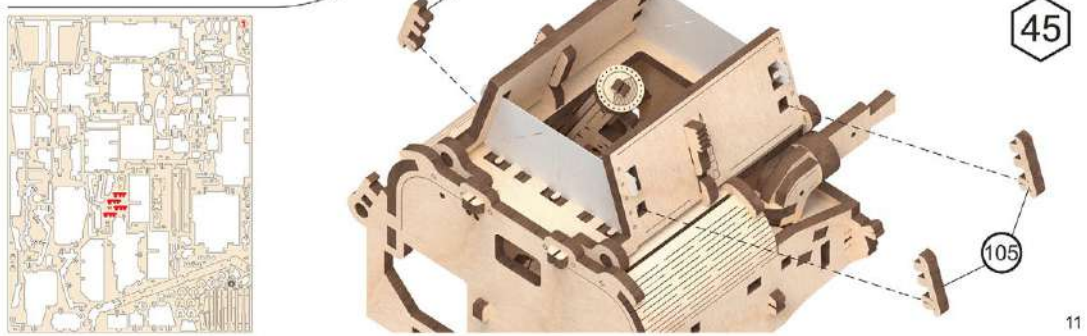
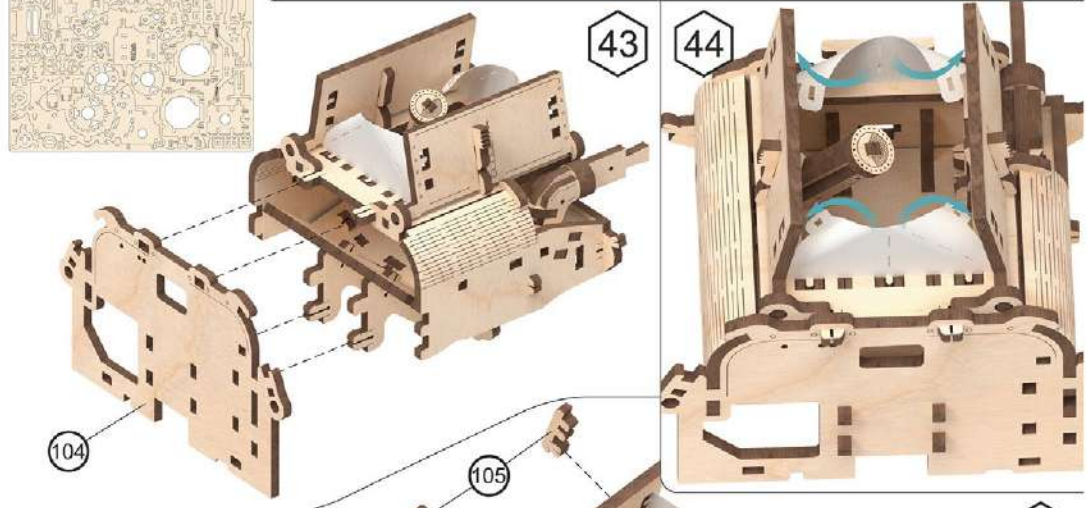
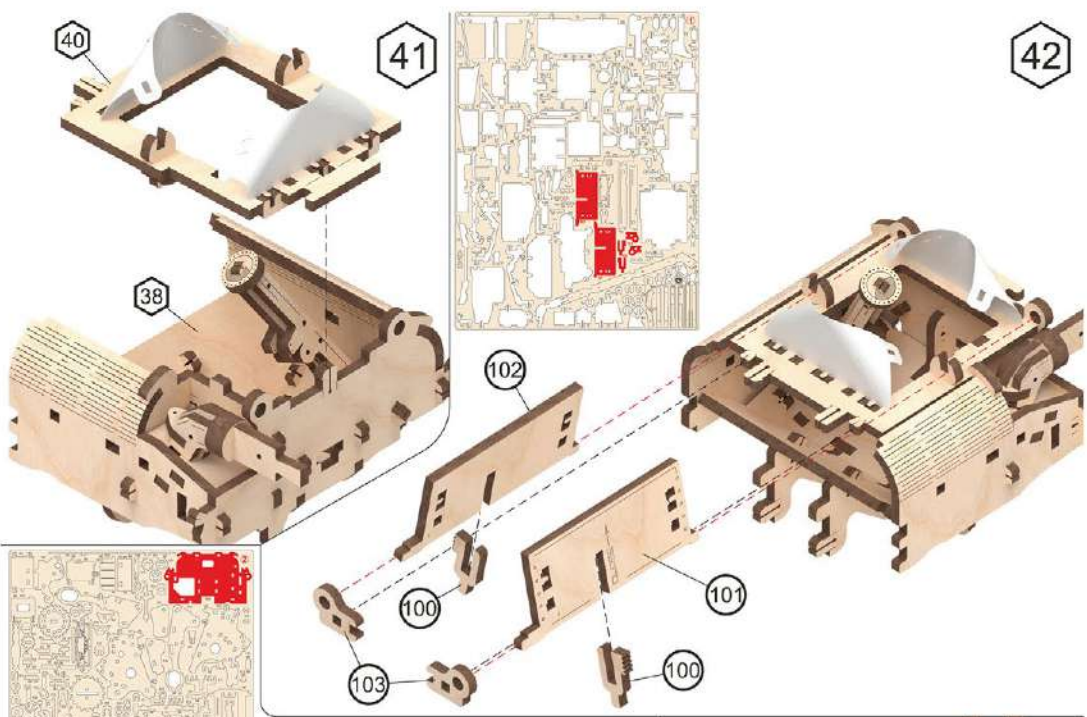

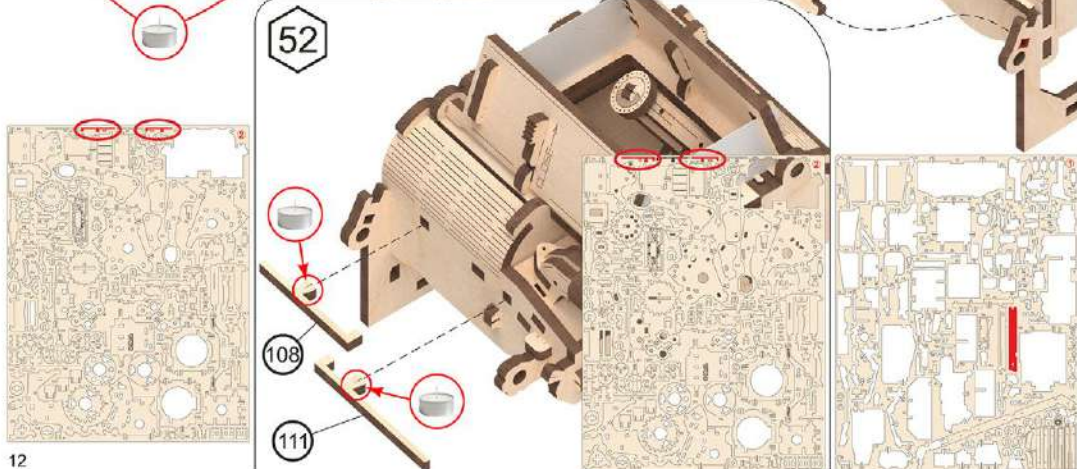
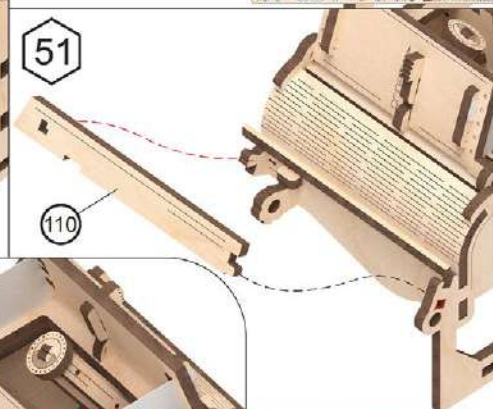
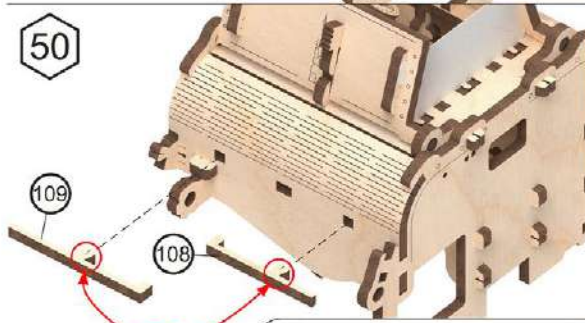
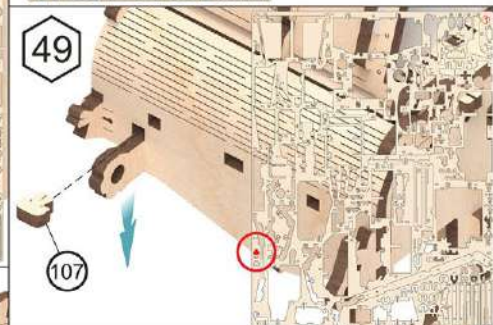
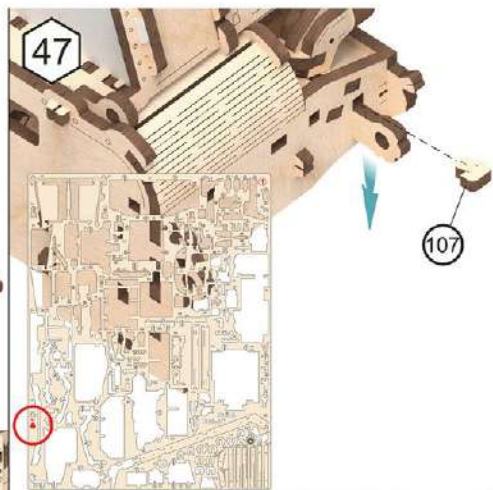
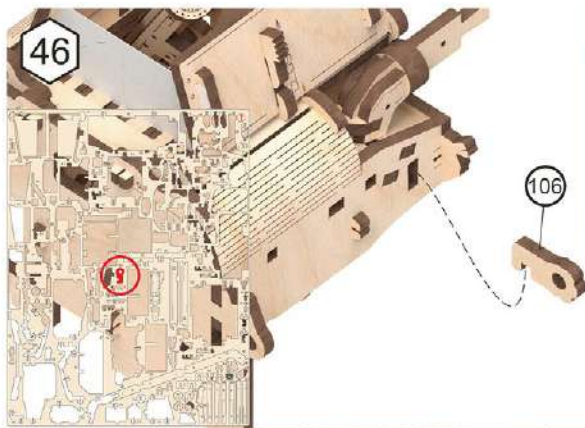

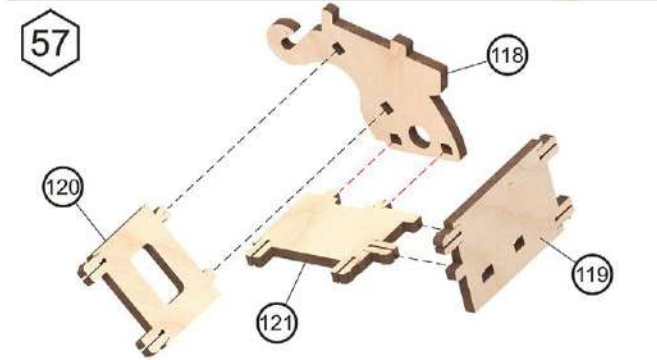
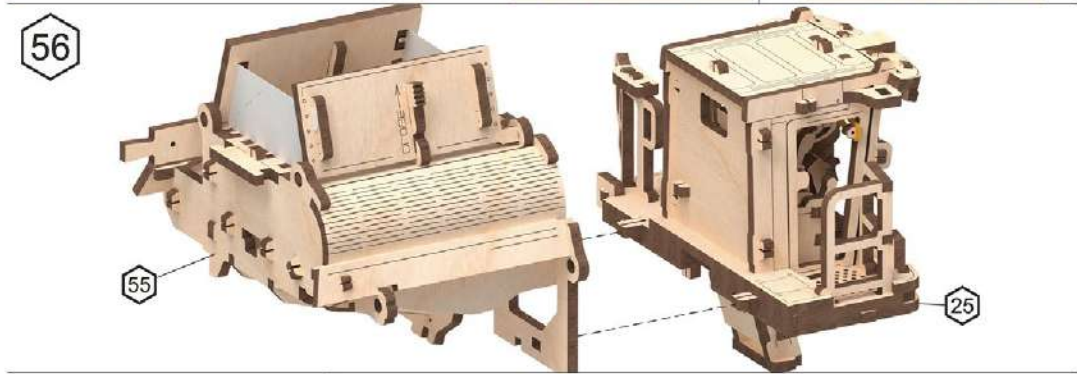
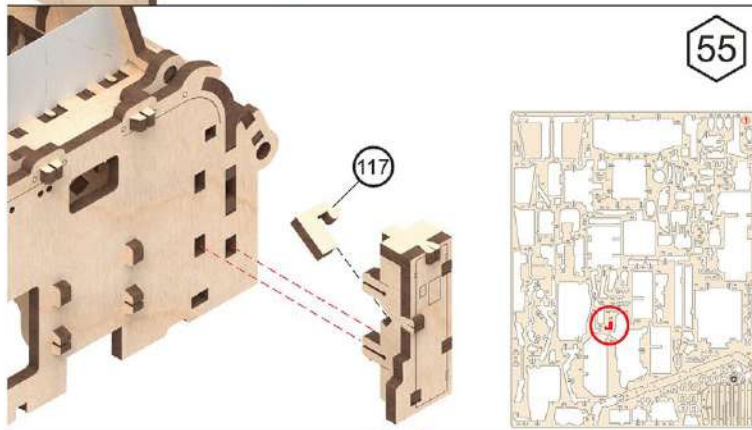
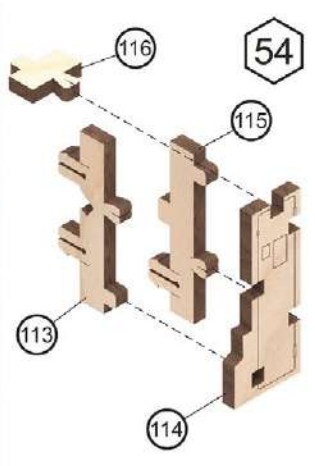
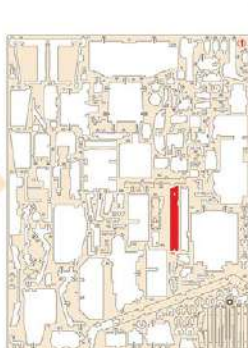
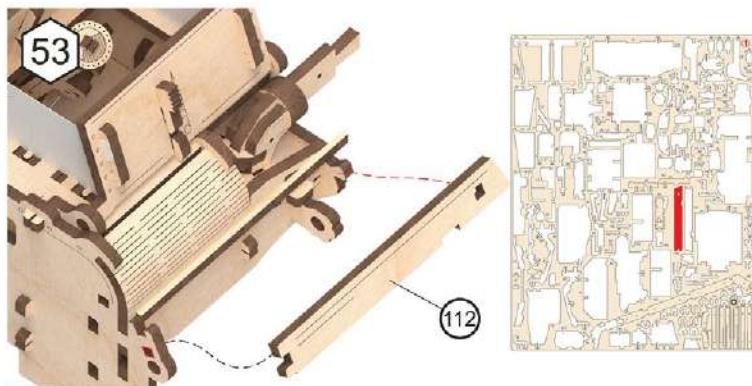

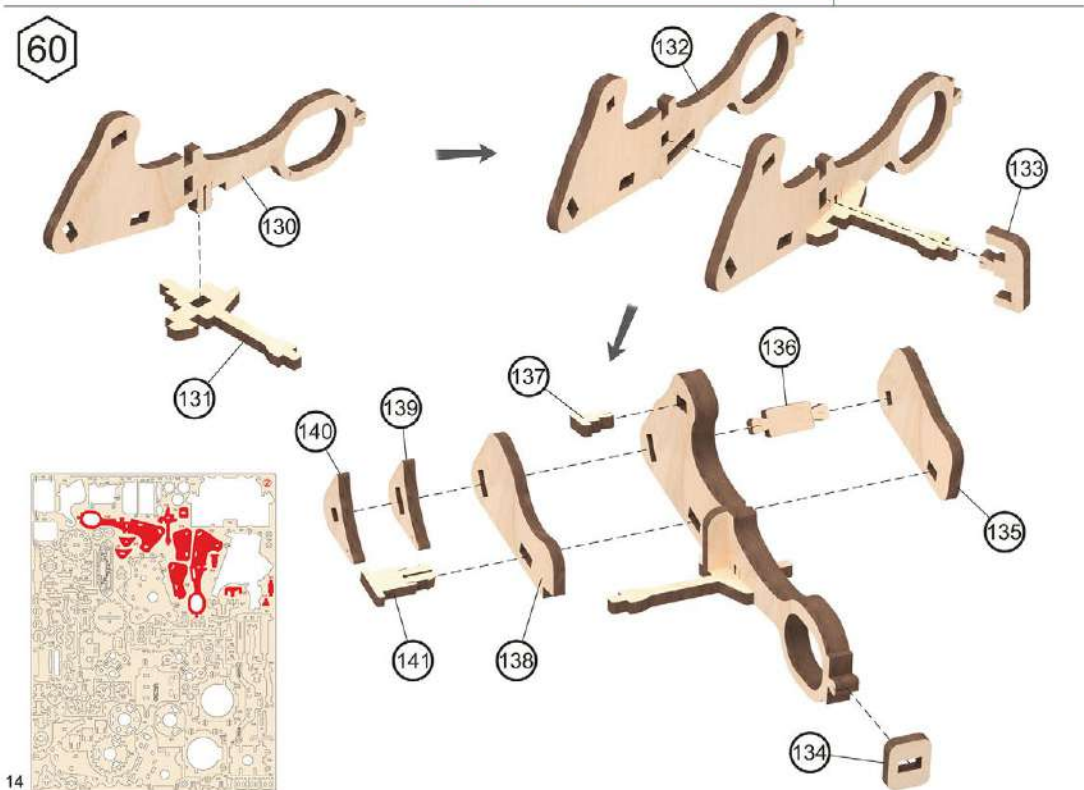
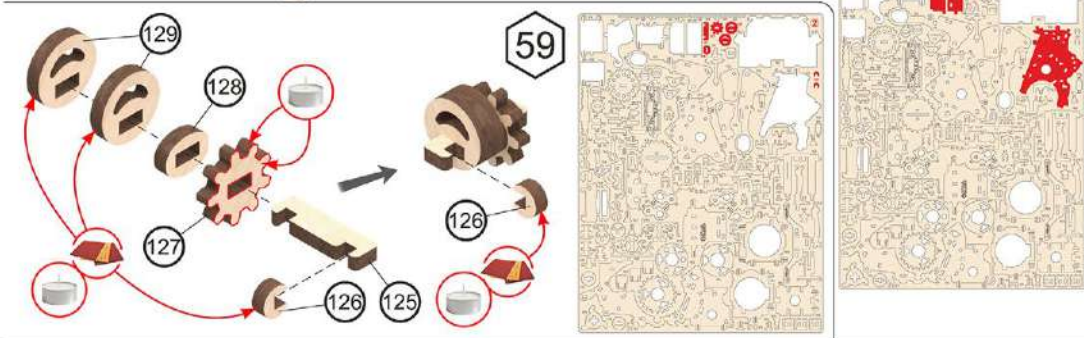
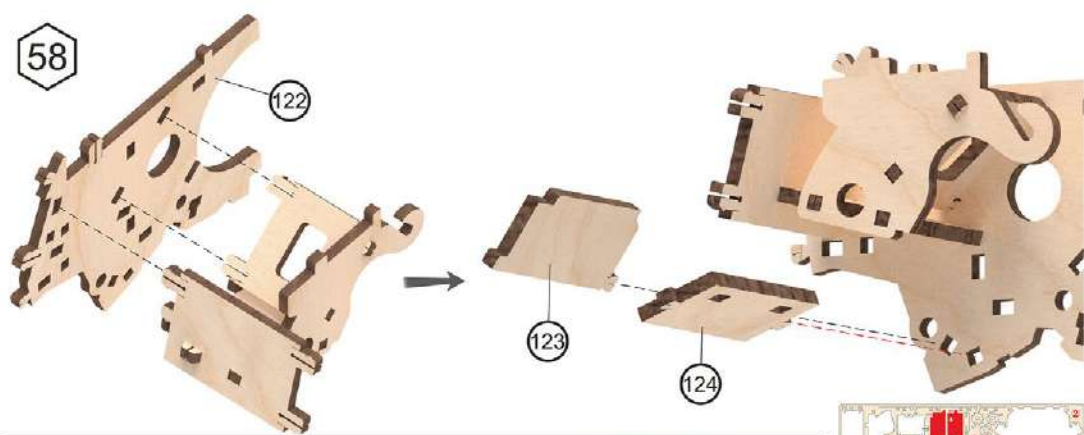

61

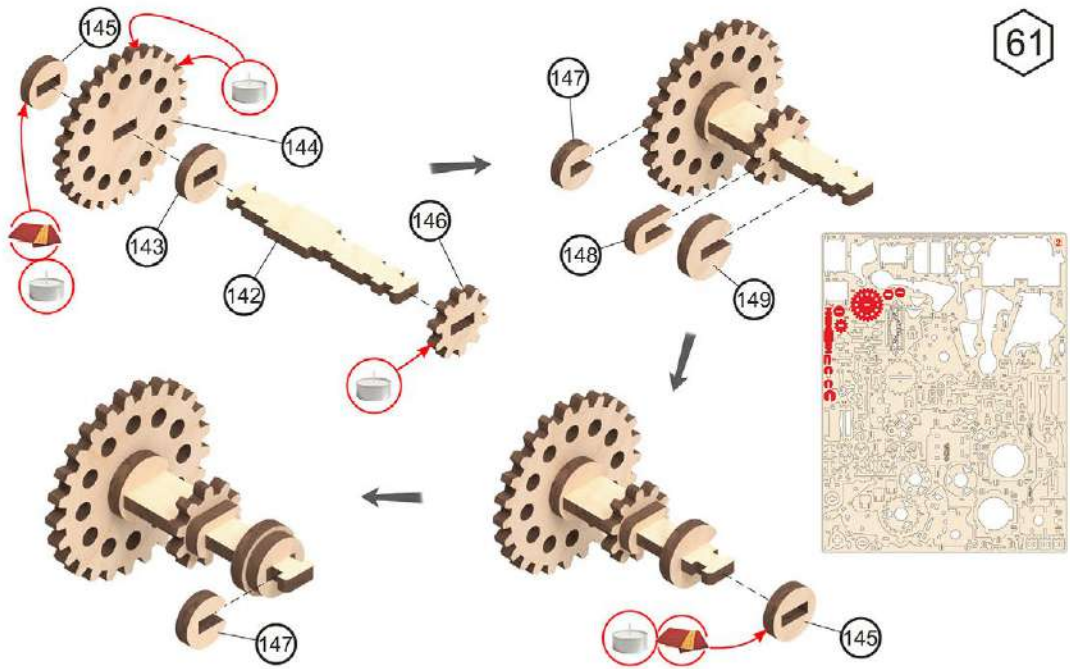

62

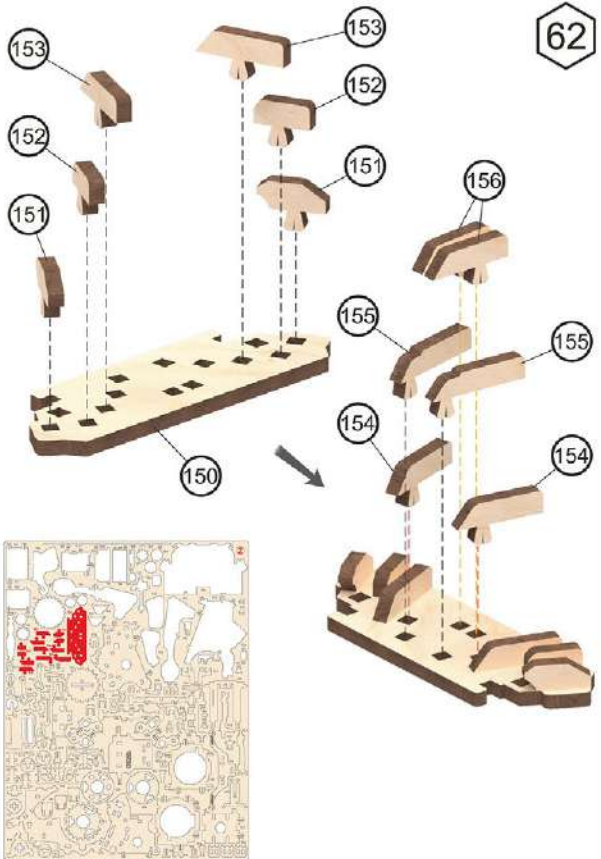

63

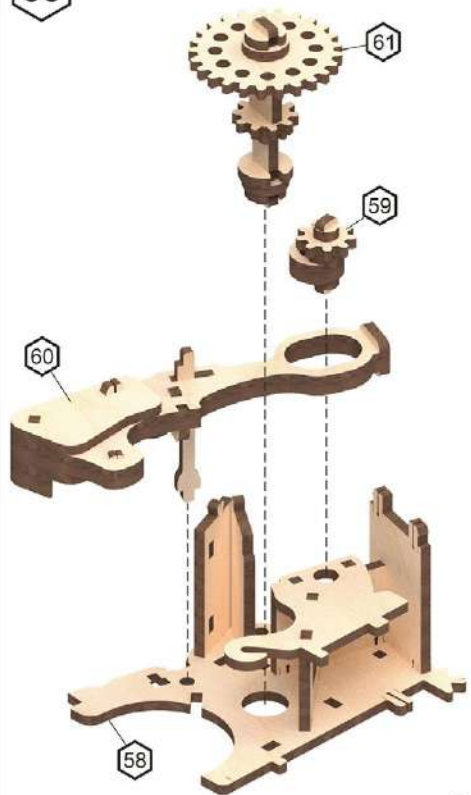

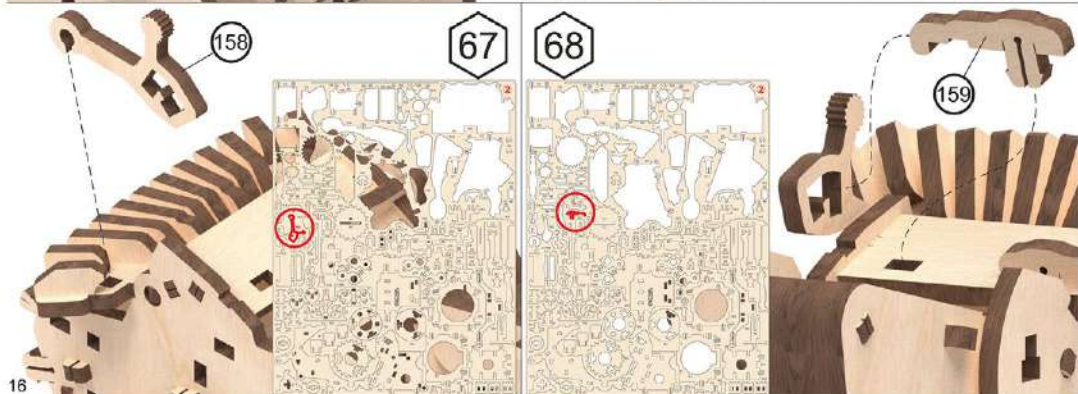
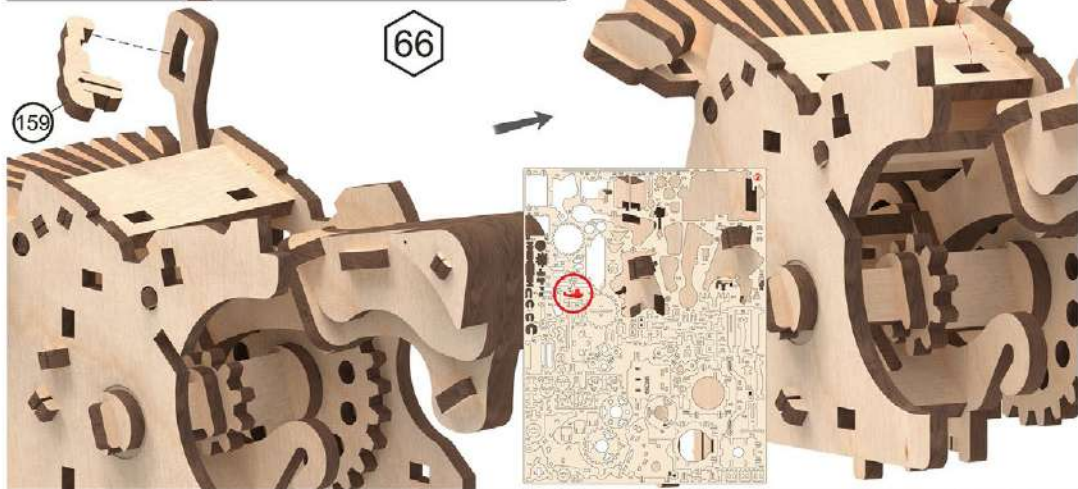
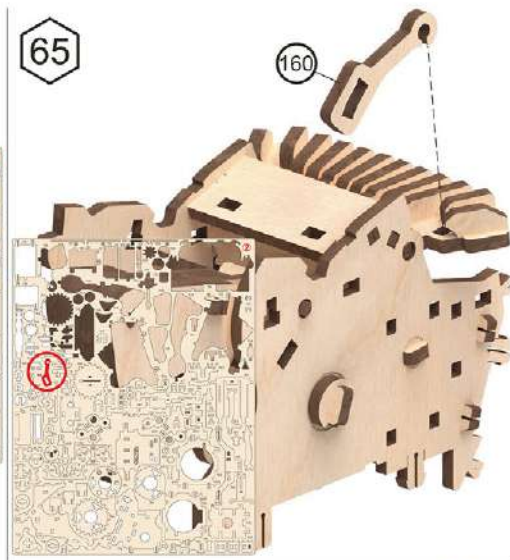
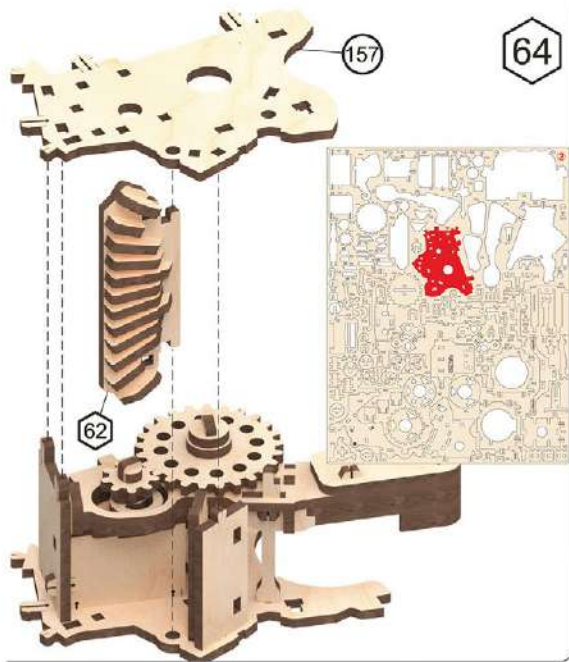



69

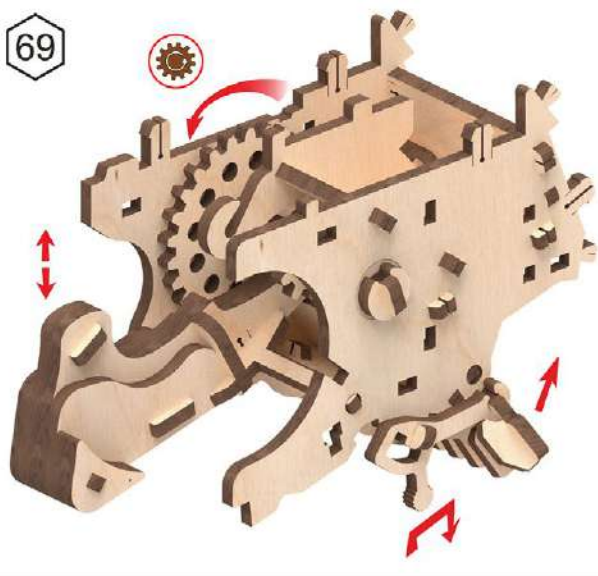

70

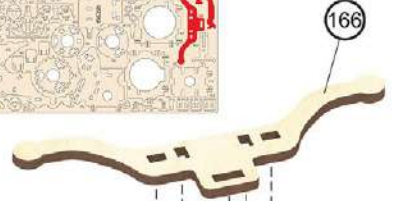
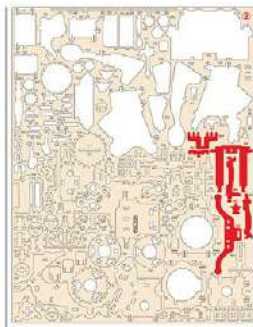

165

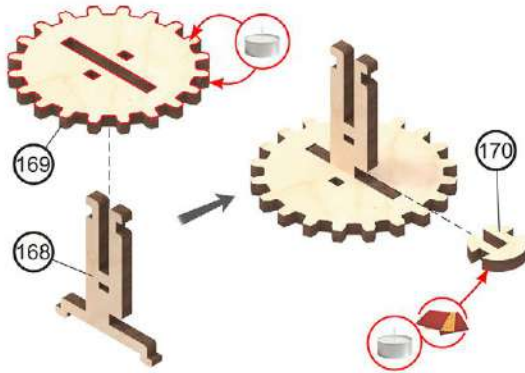
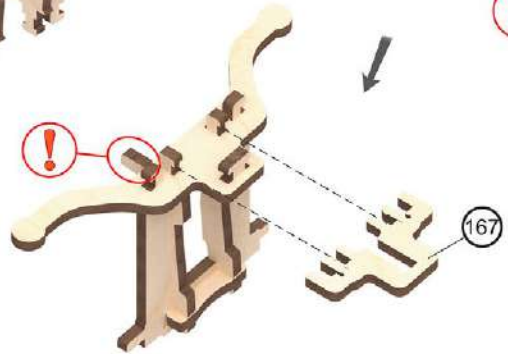
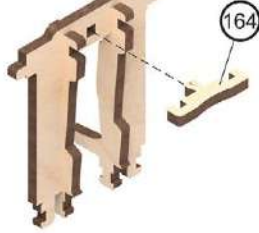
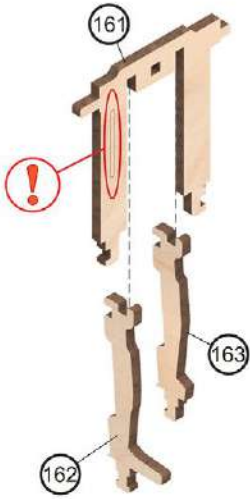

71

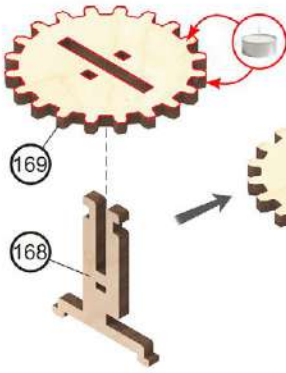
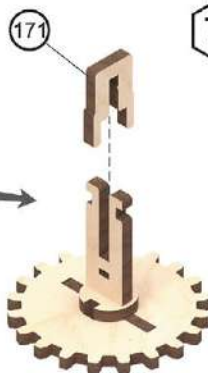
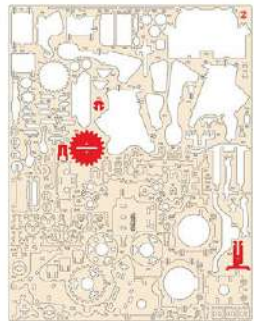

72

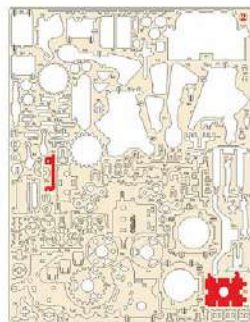
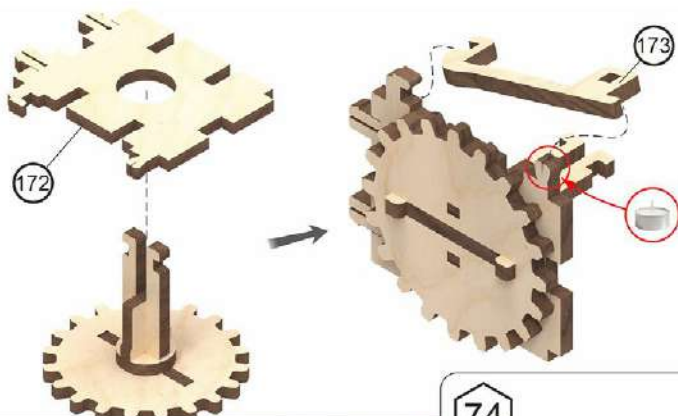

73

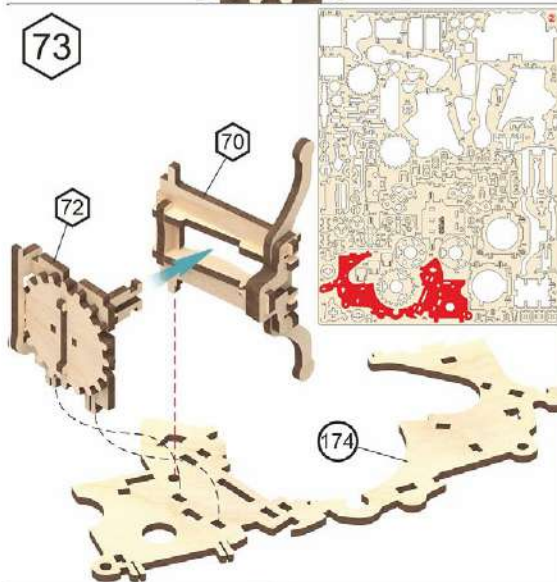

74

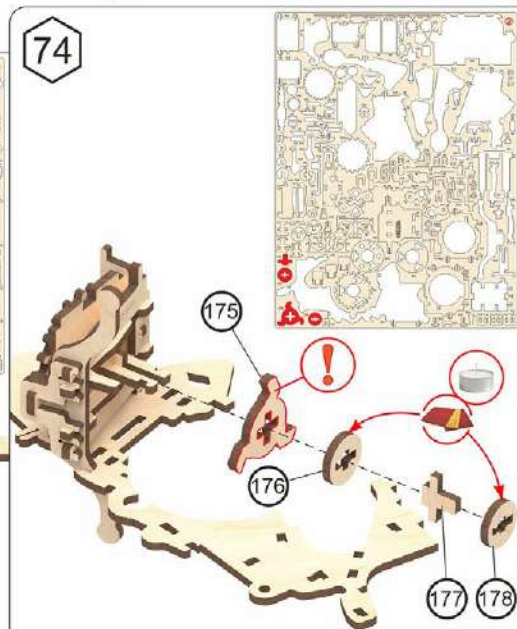

75

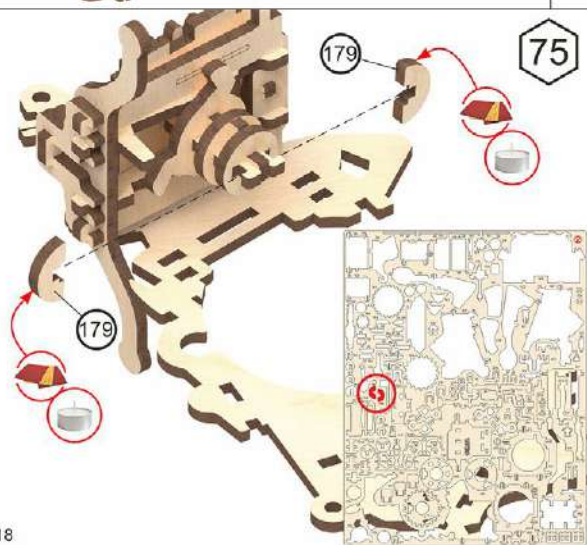

76

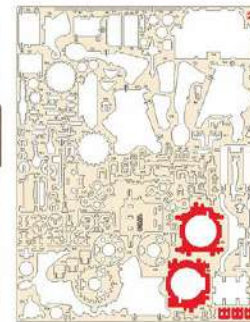
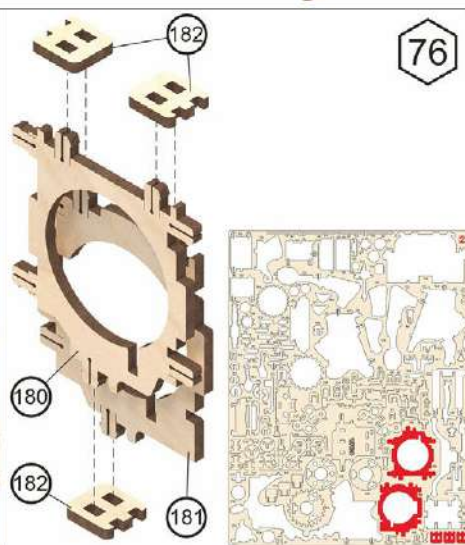

77

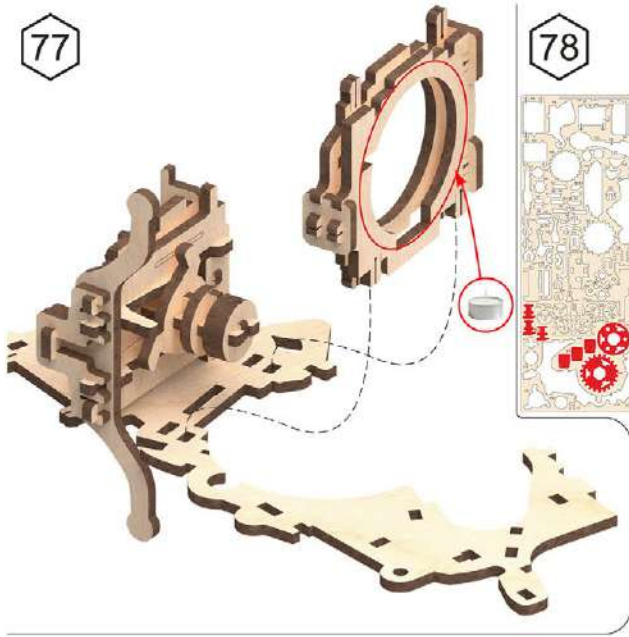

78

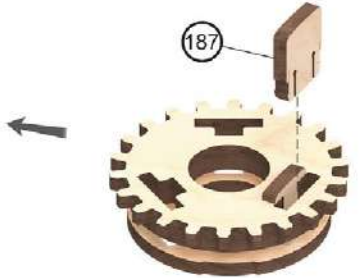
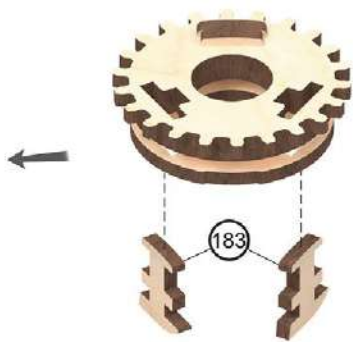
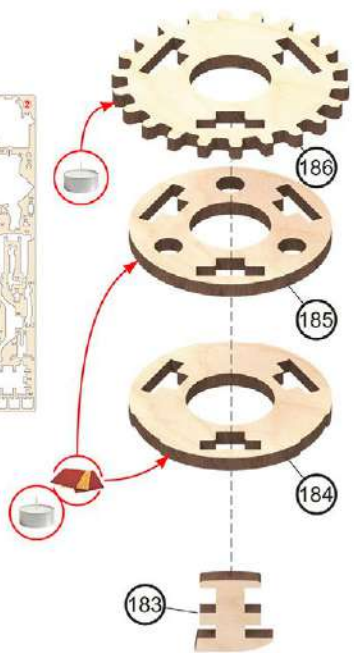
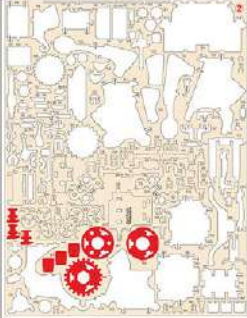

79

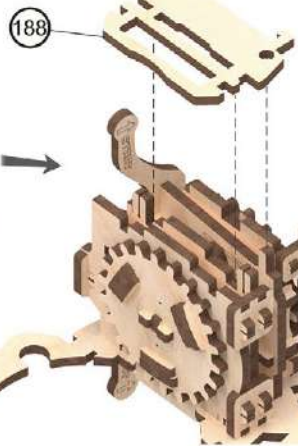
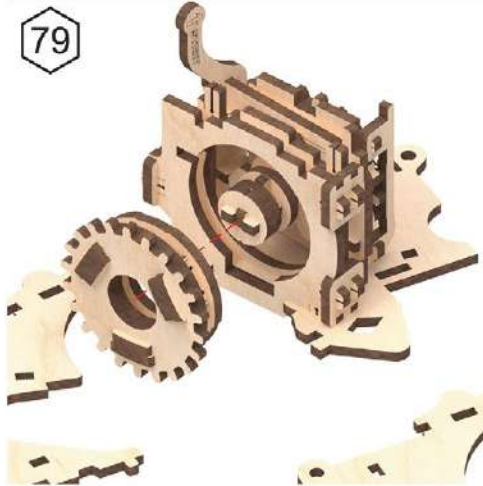

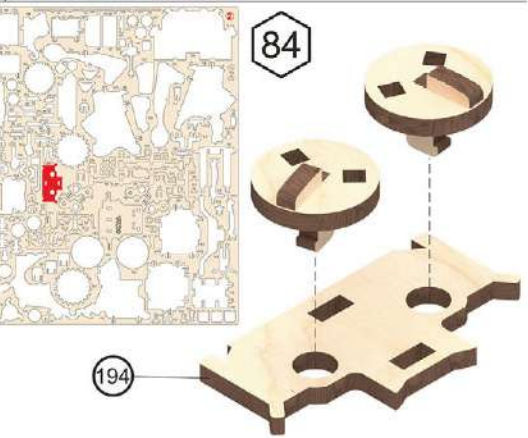
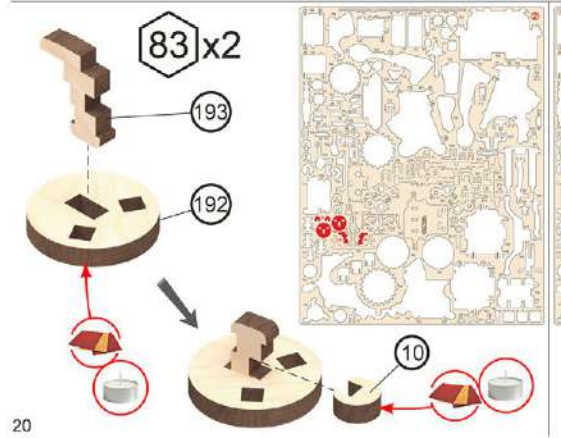
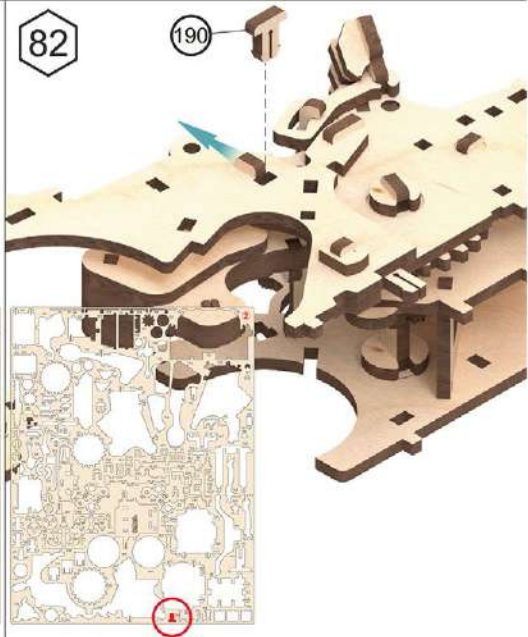
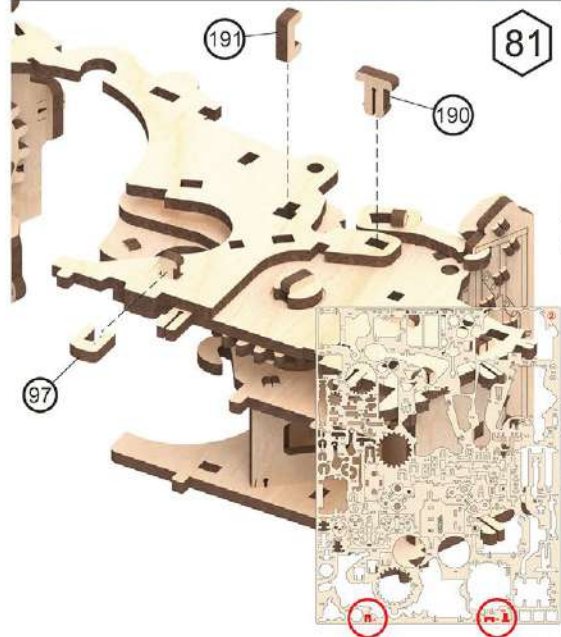
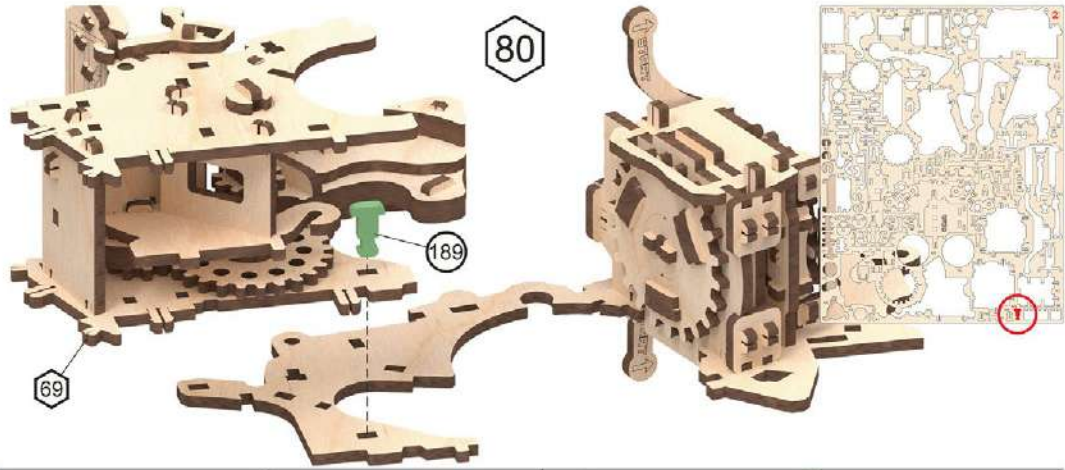

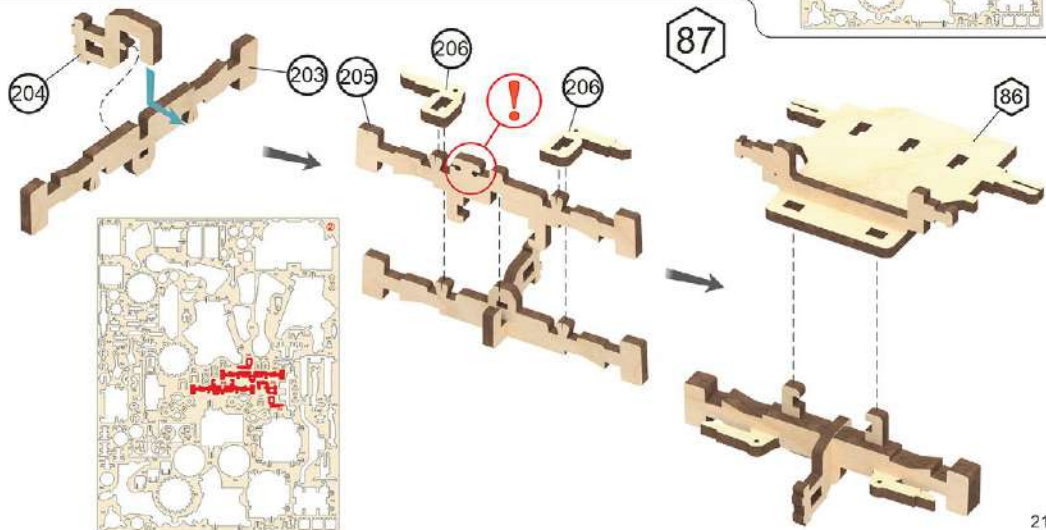
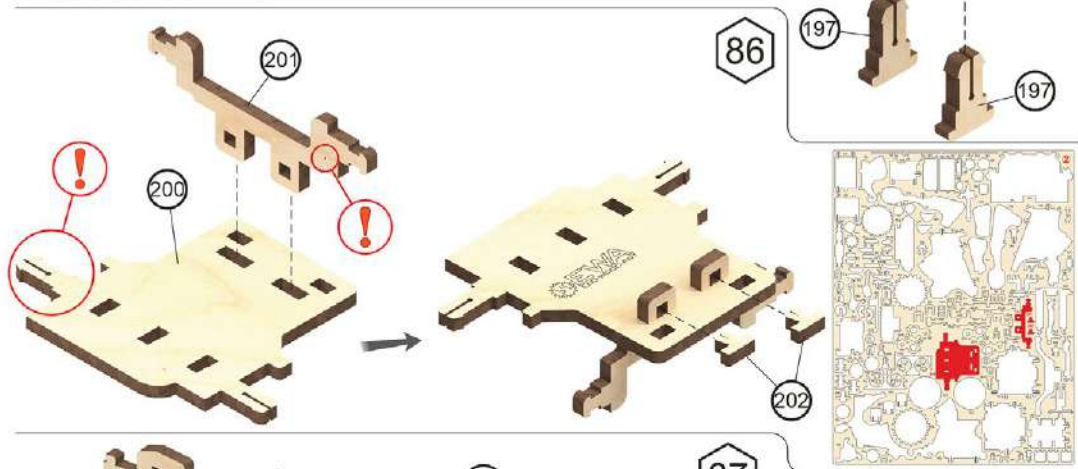
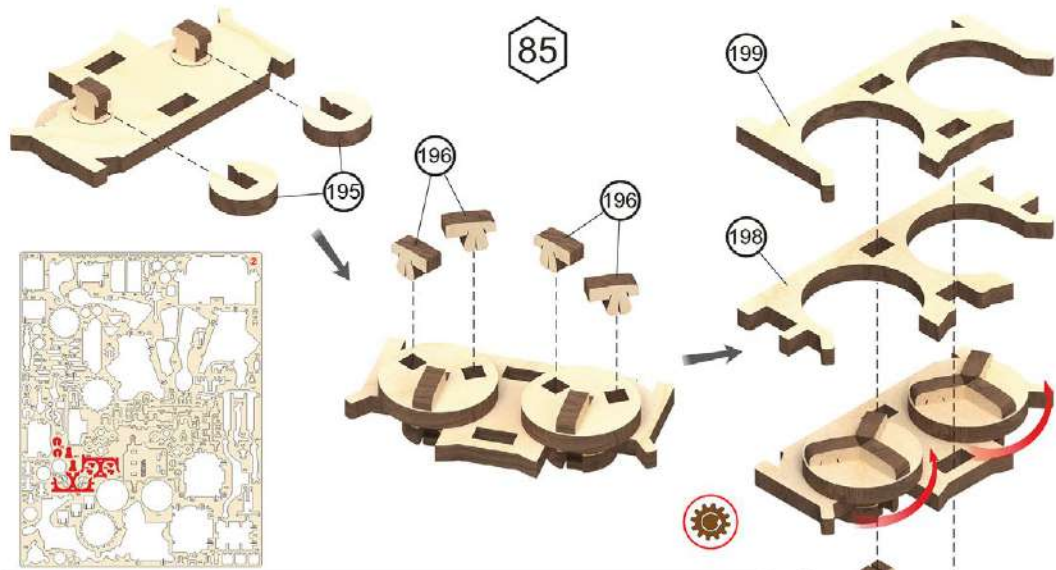

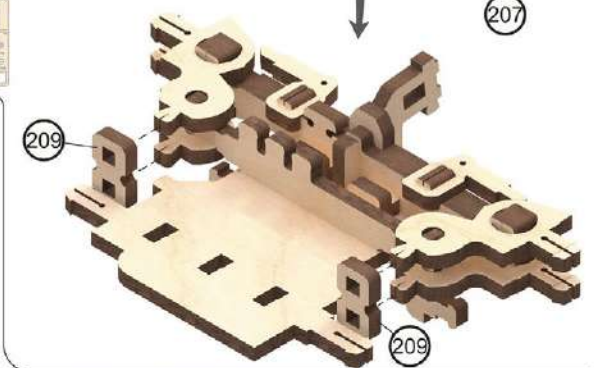
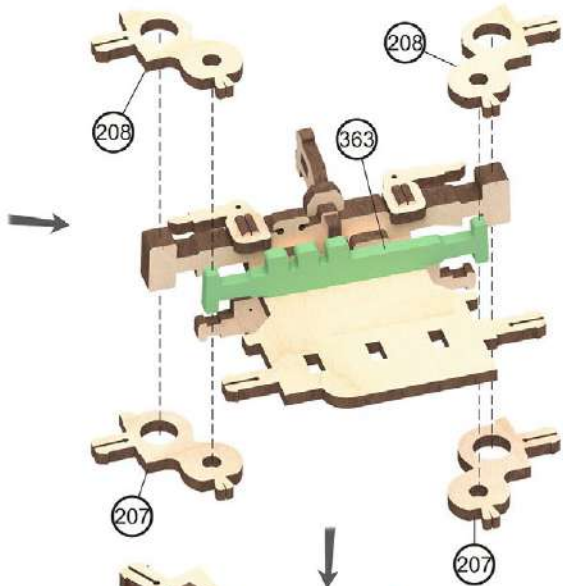
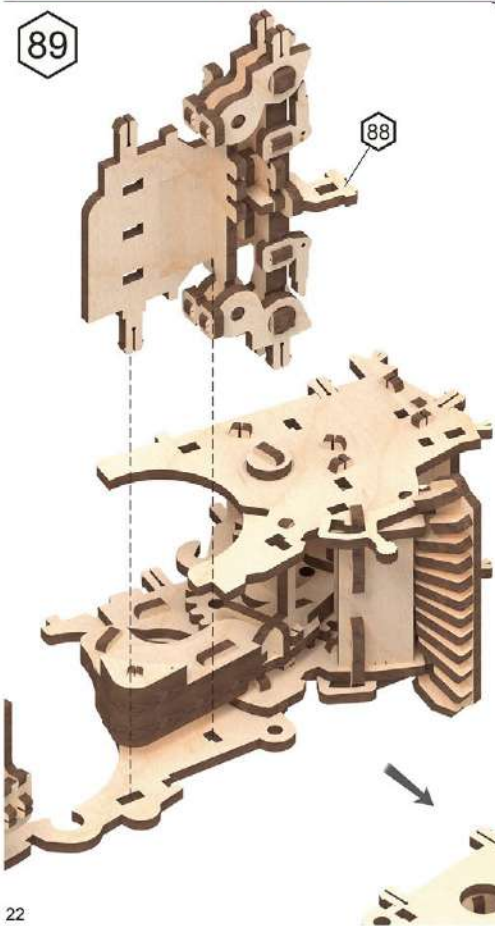
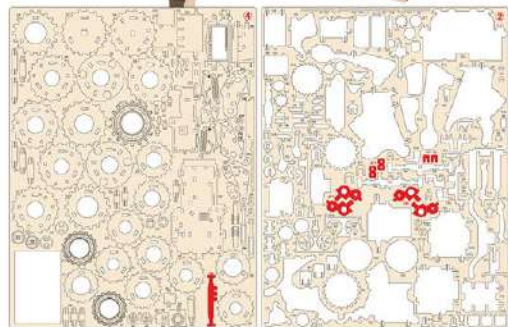
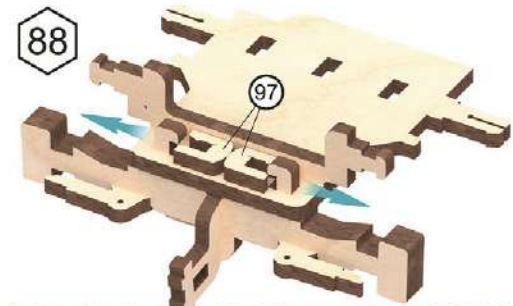

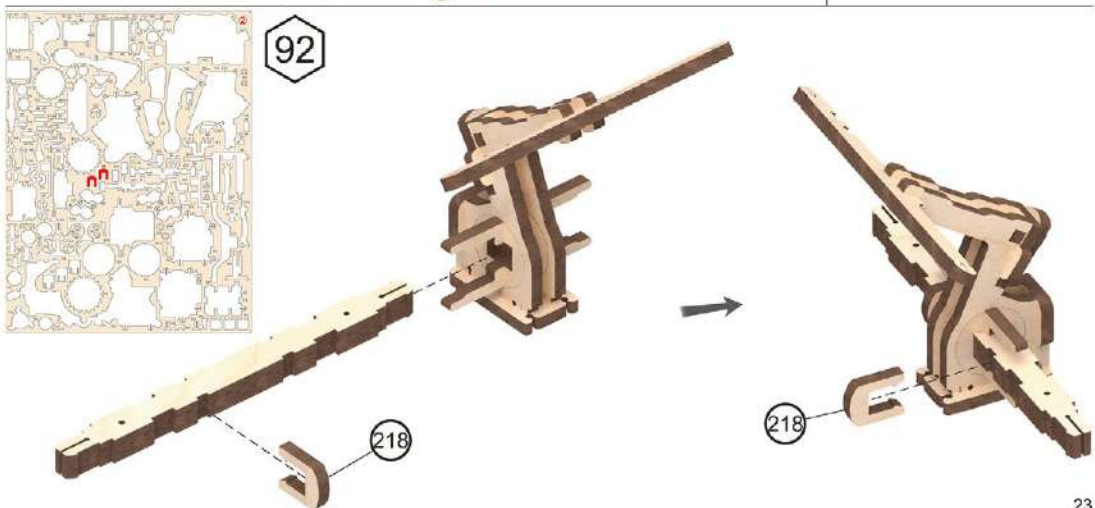
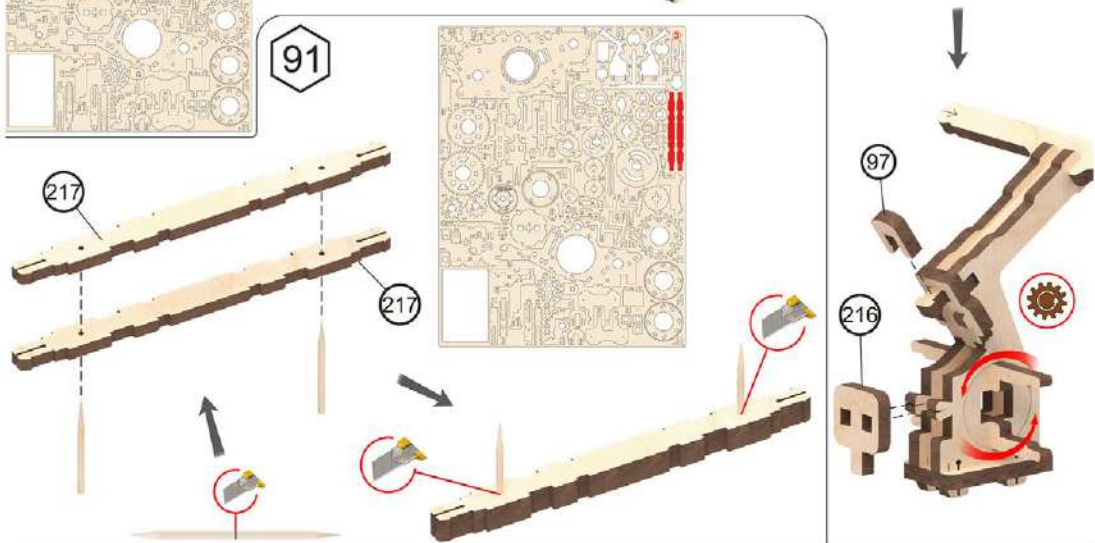
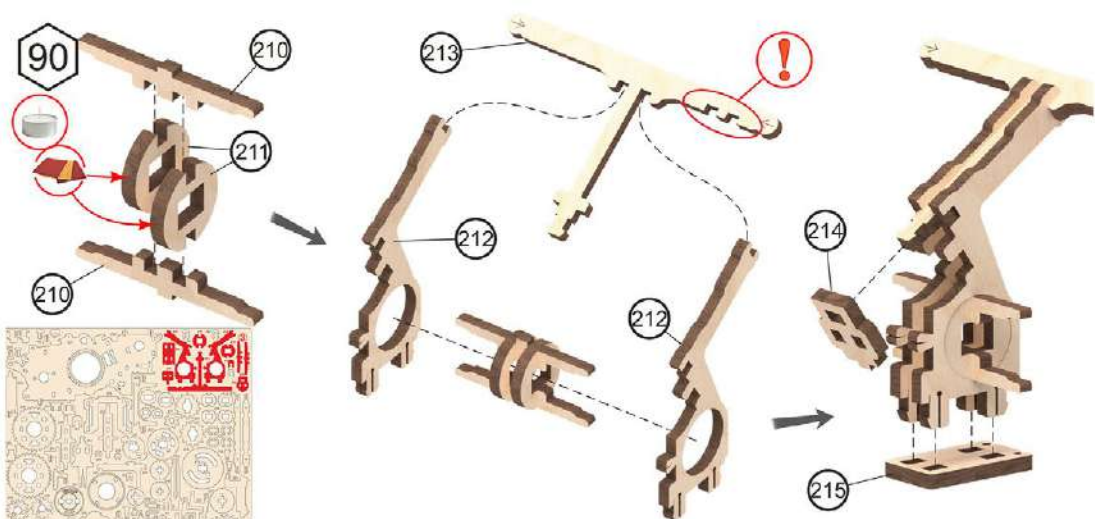

93

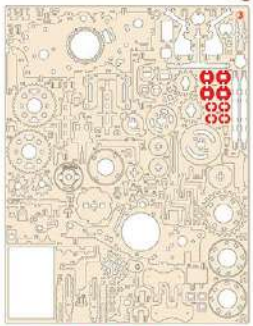
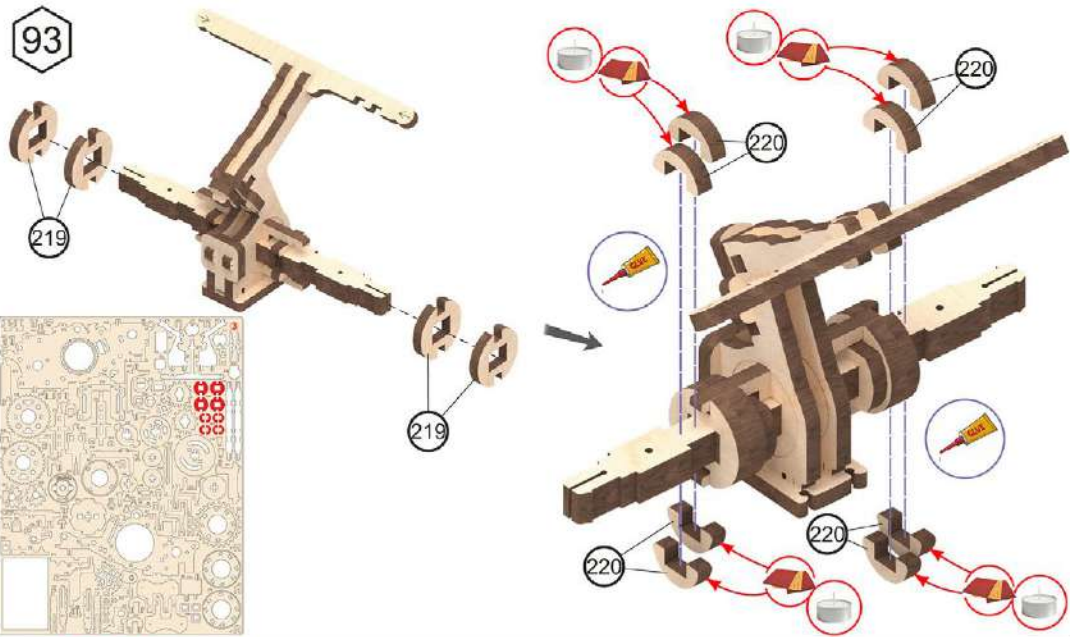

94

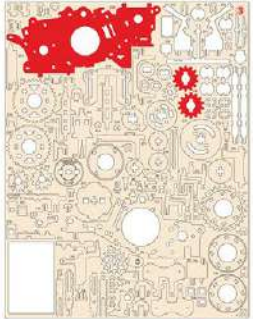
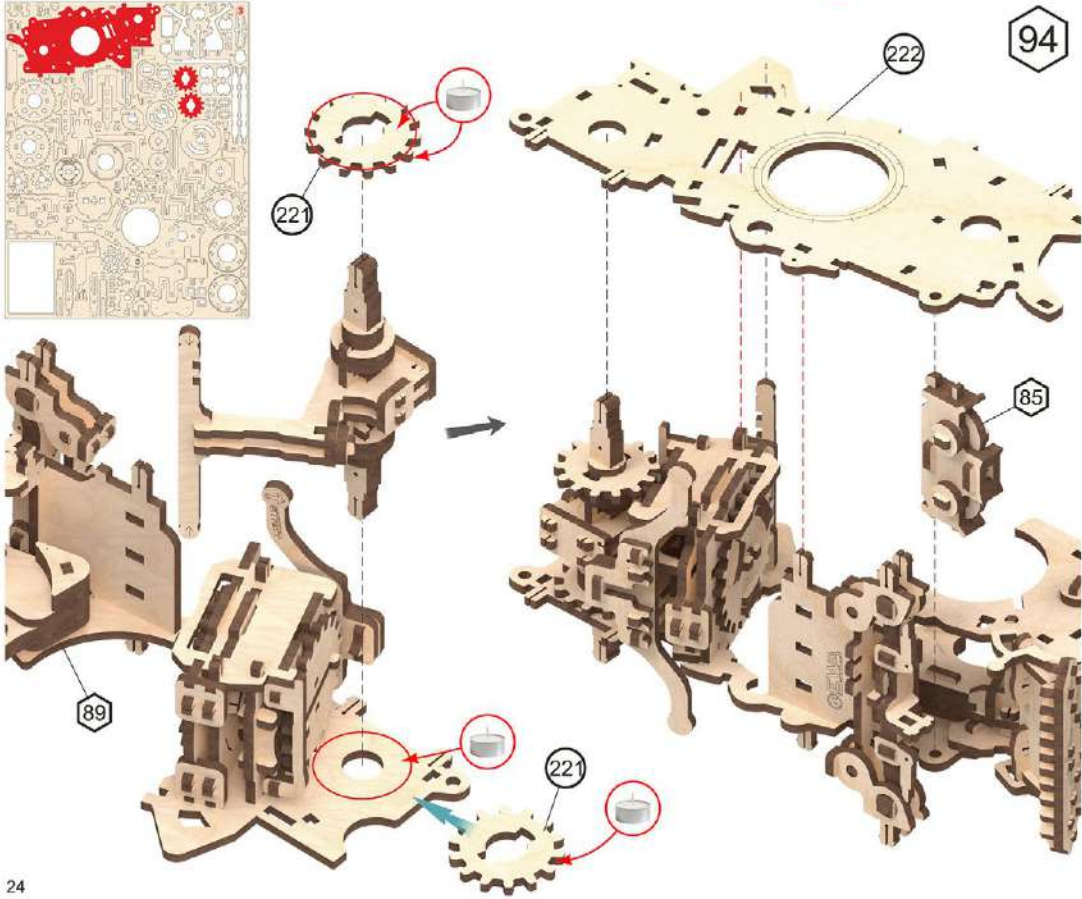



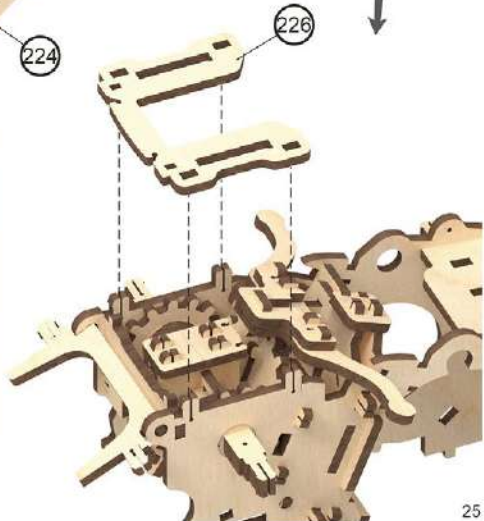
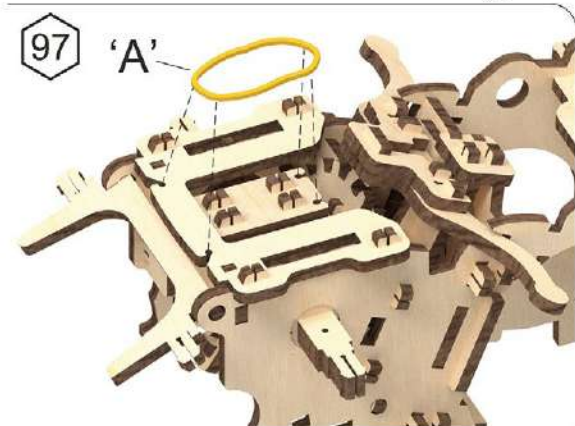
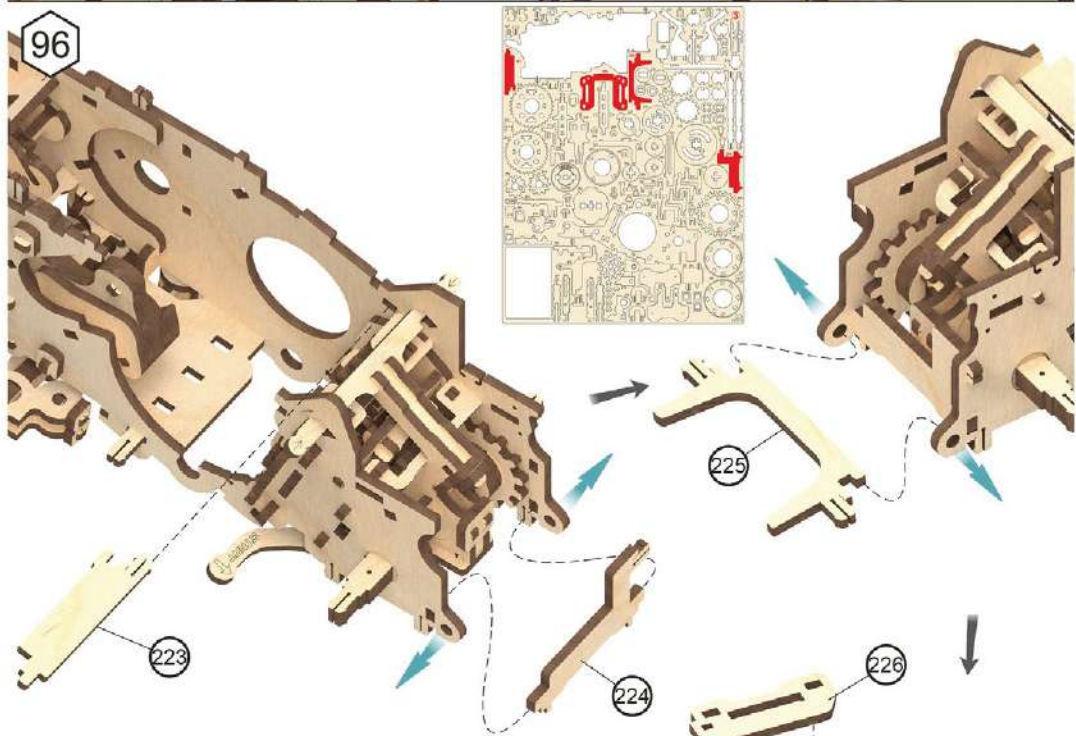
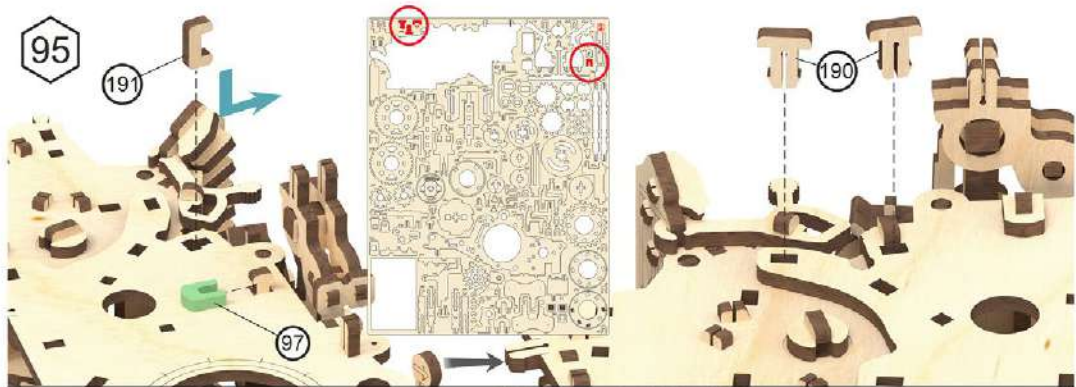

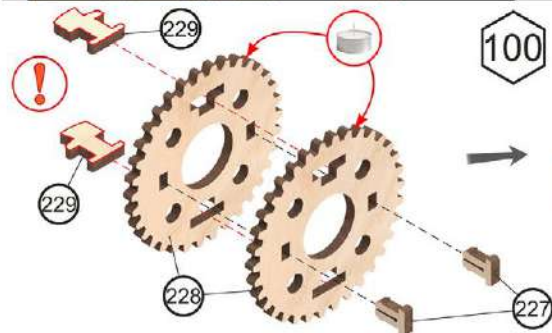
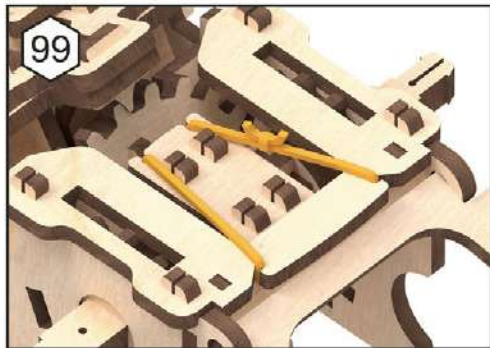
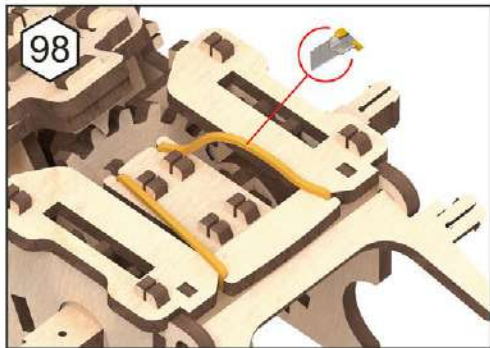

100

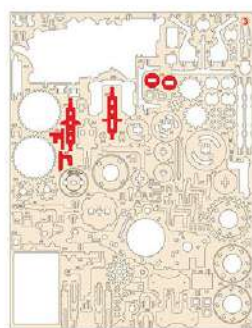
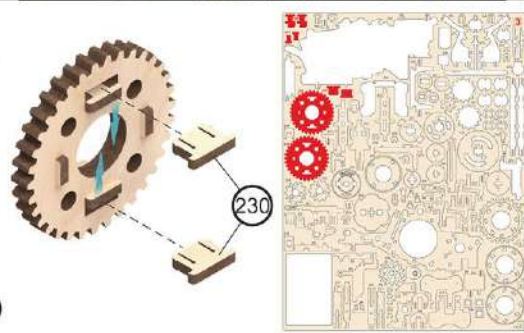

101

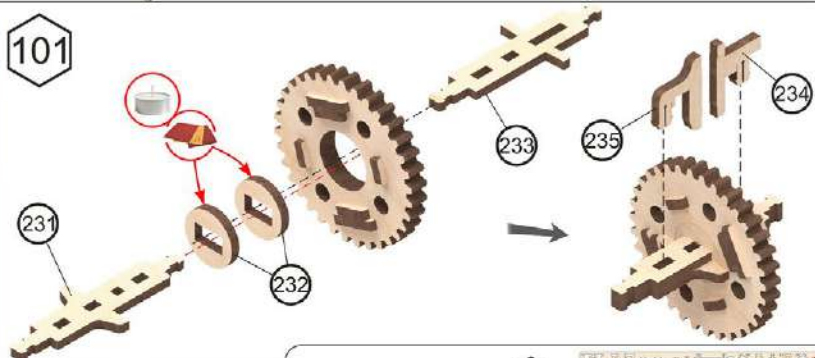

102

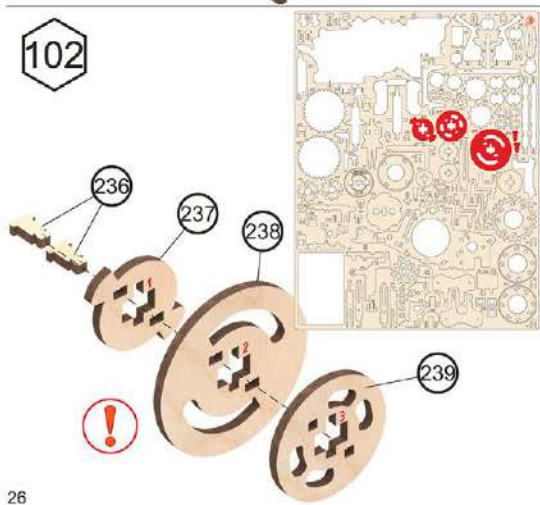

103

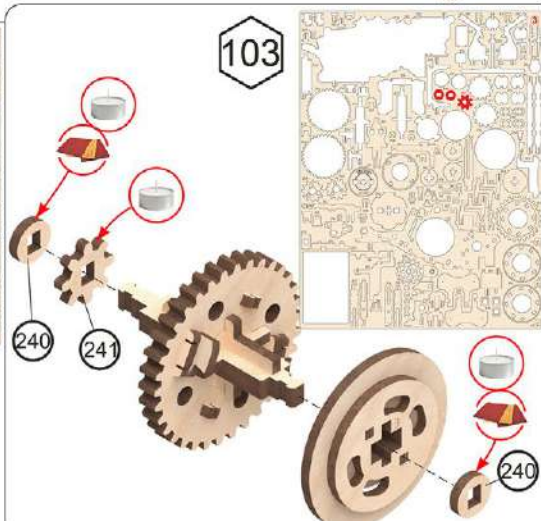

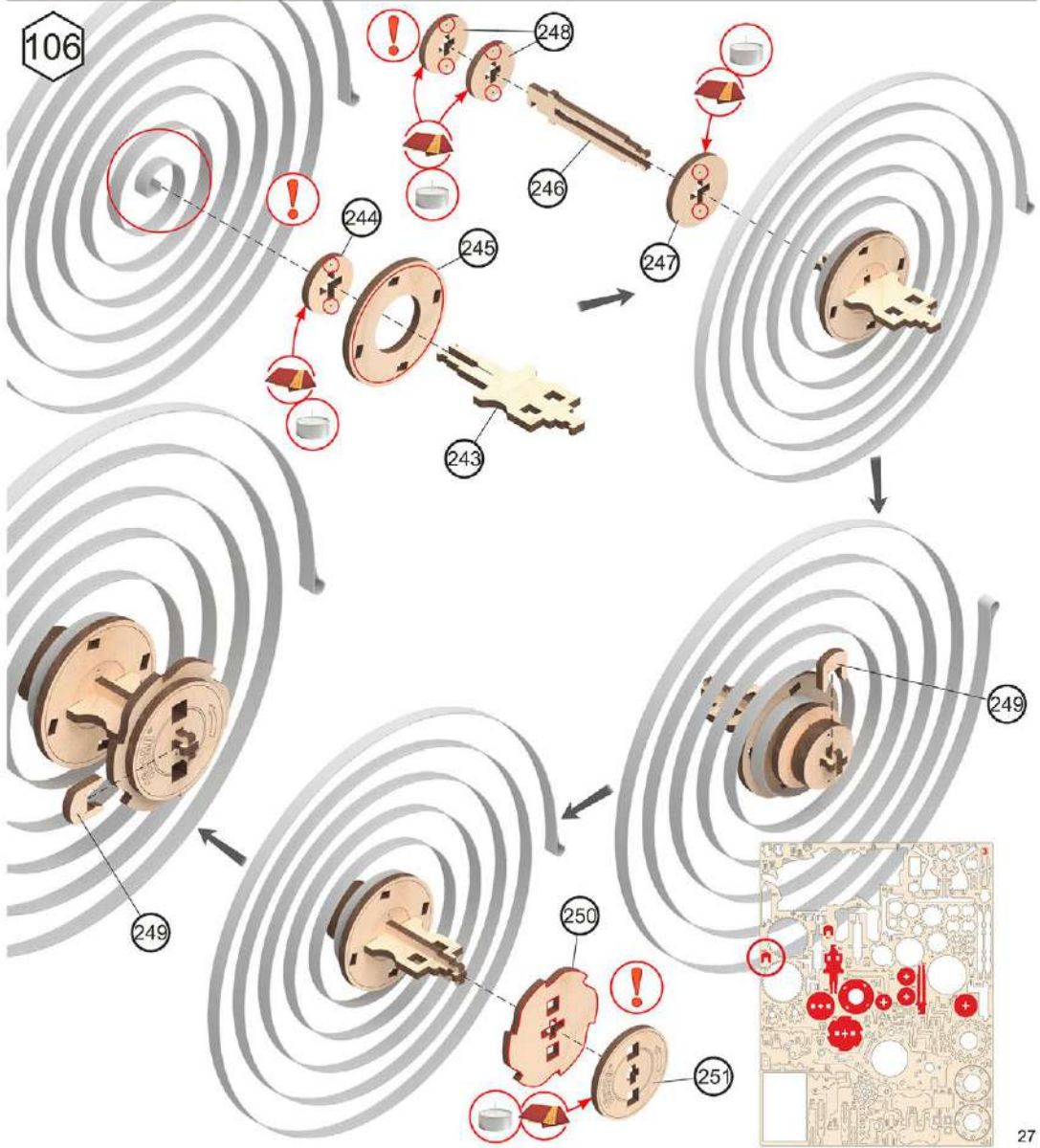
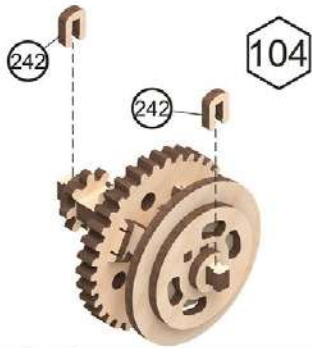
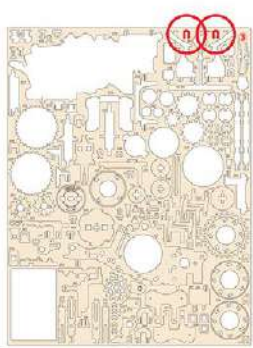

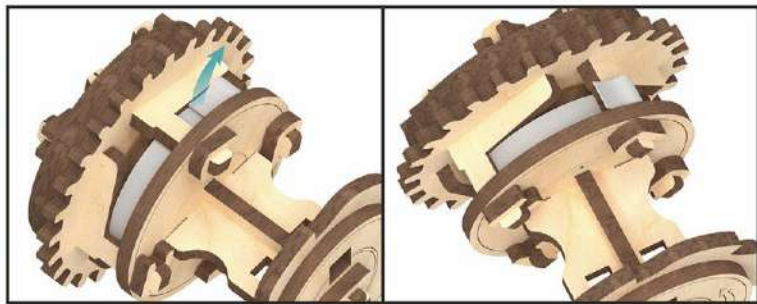
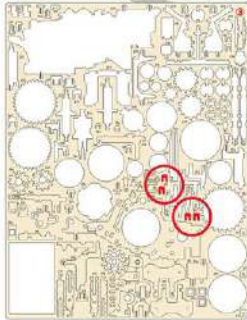
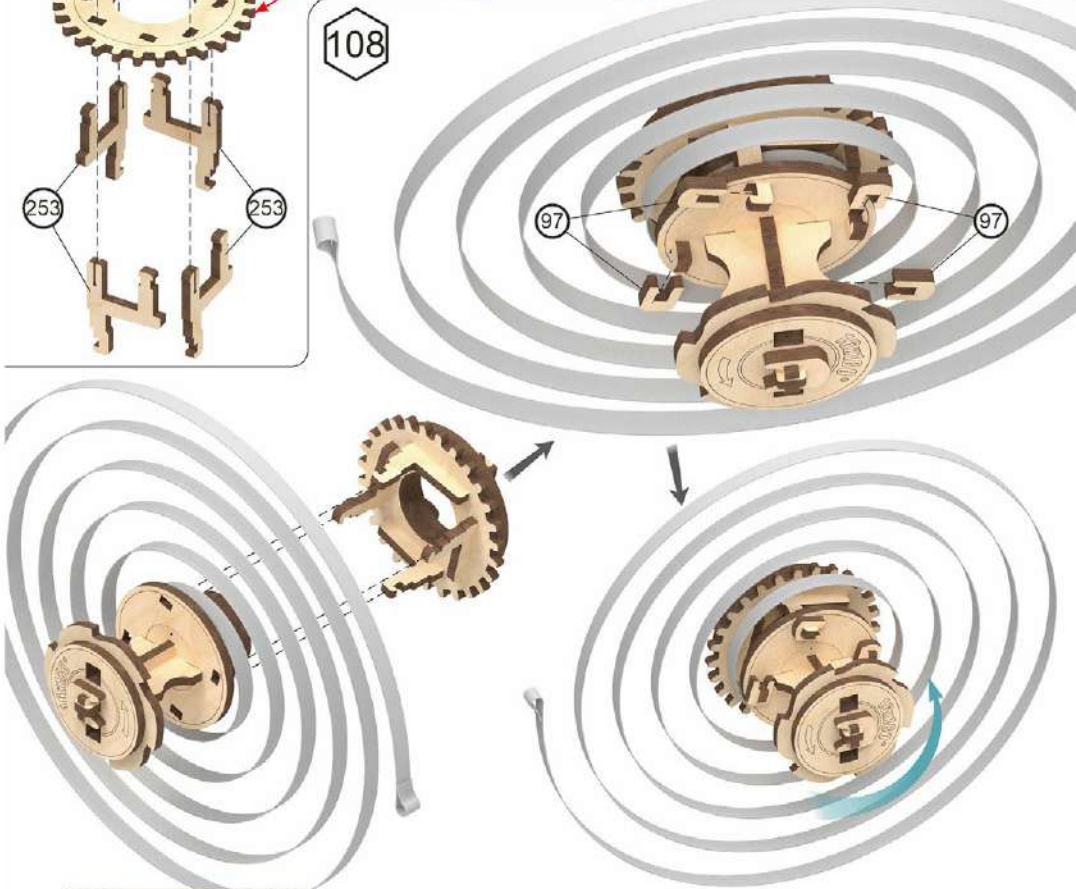
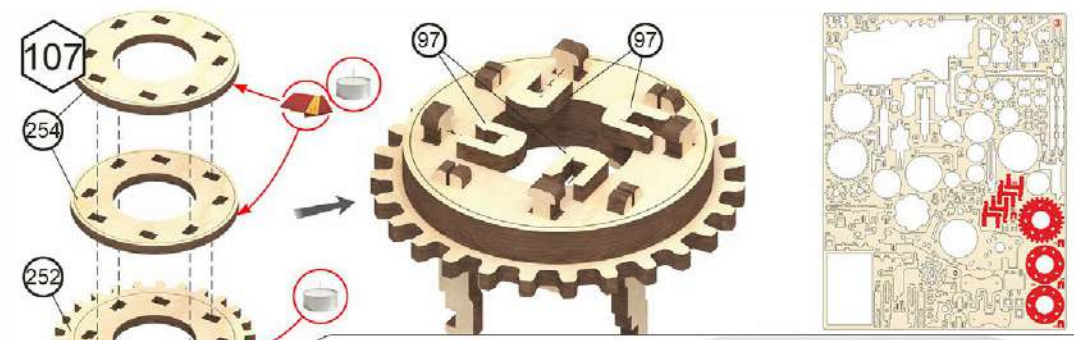

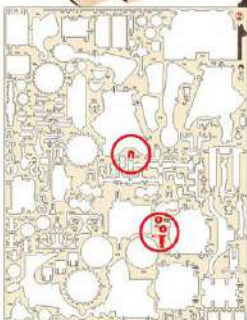
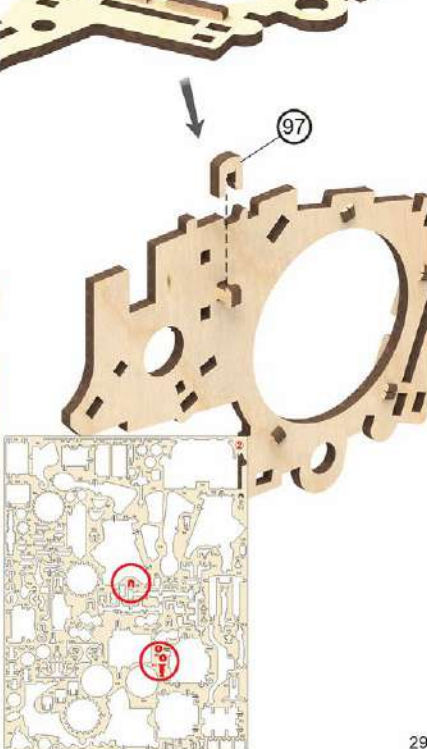
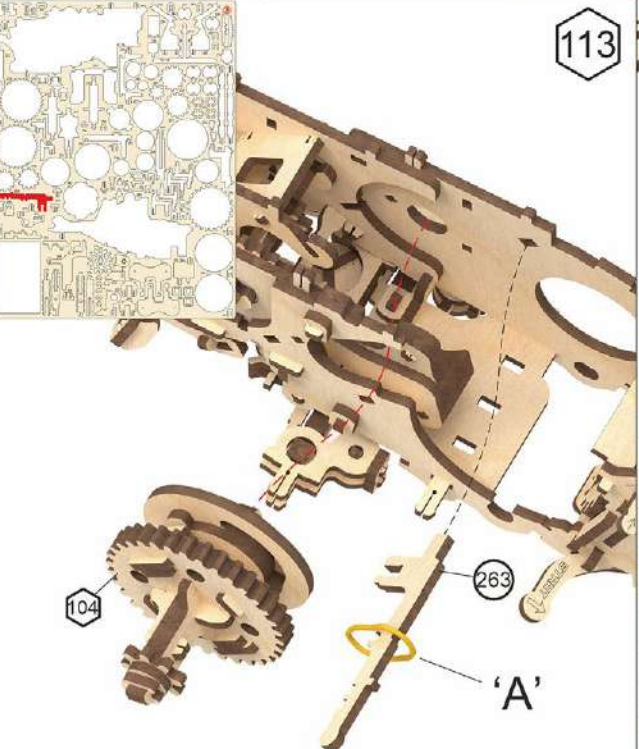
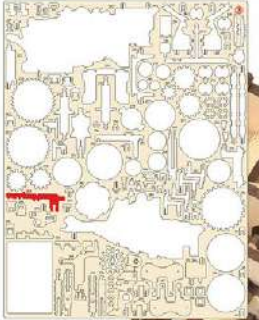
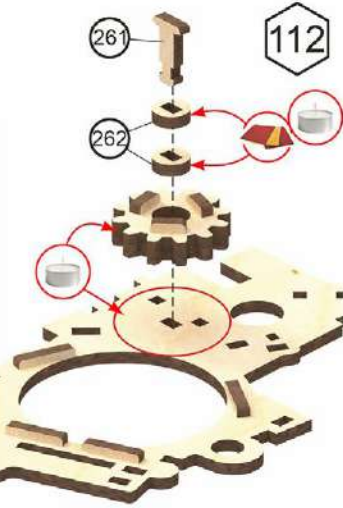
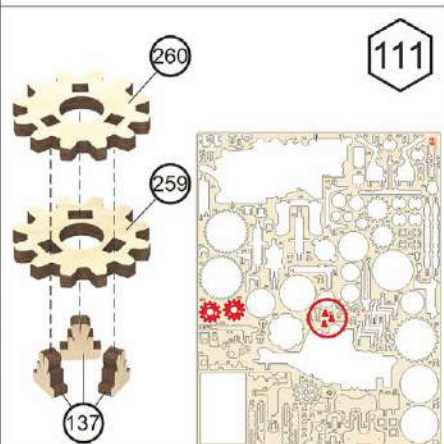
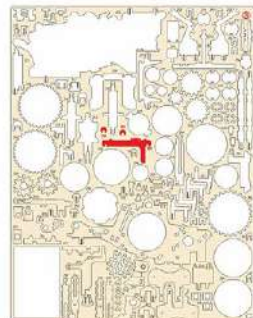
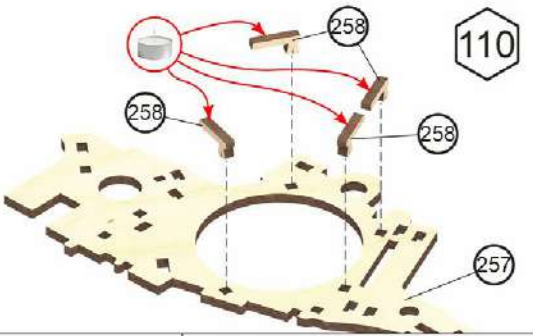
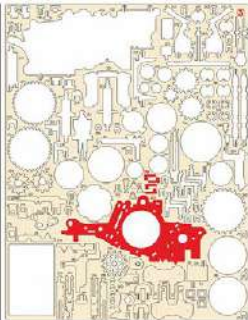
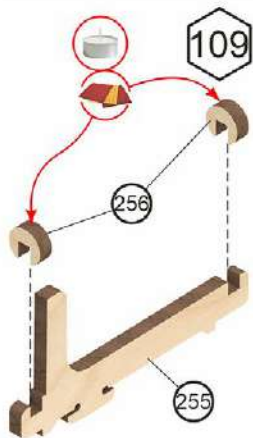

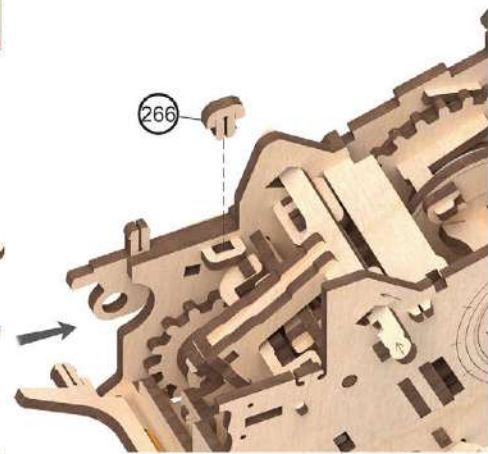
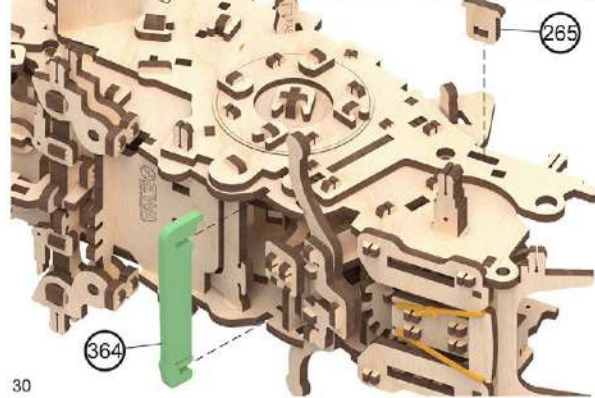
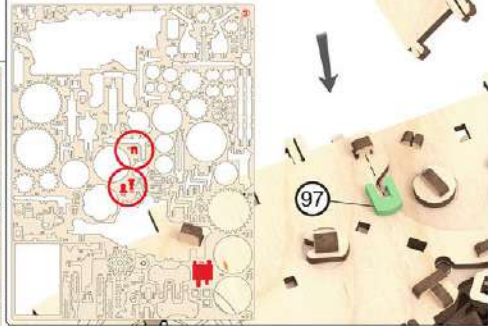
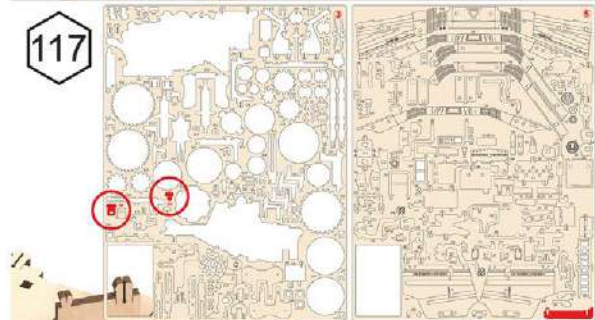
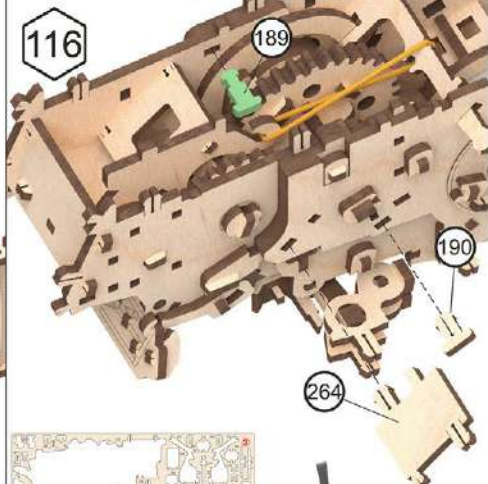
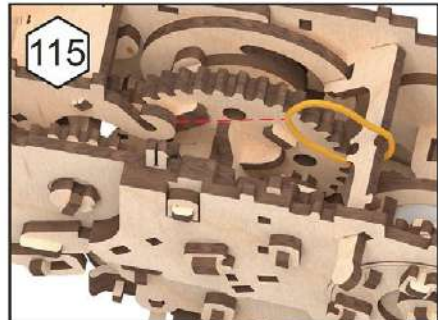
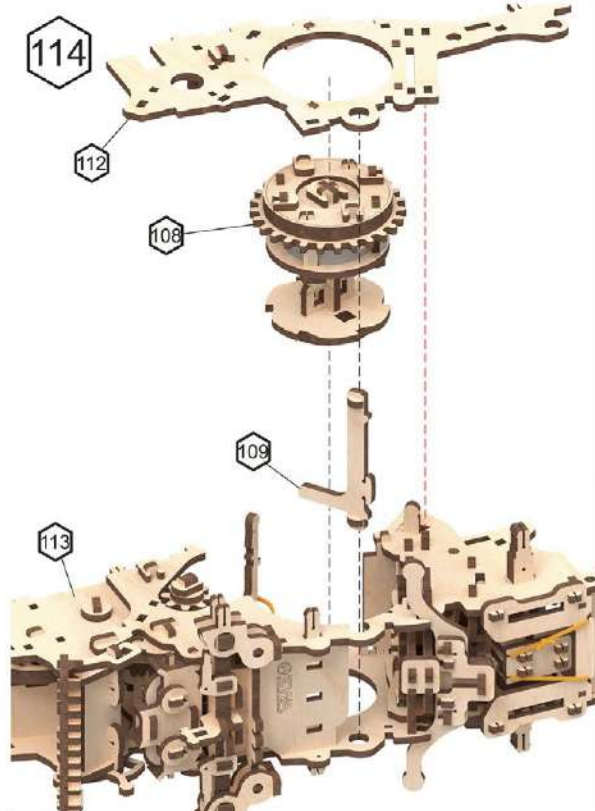

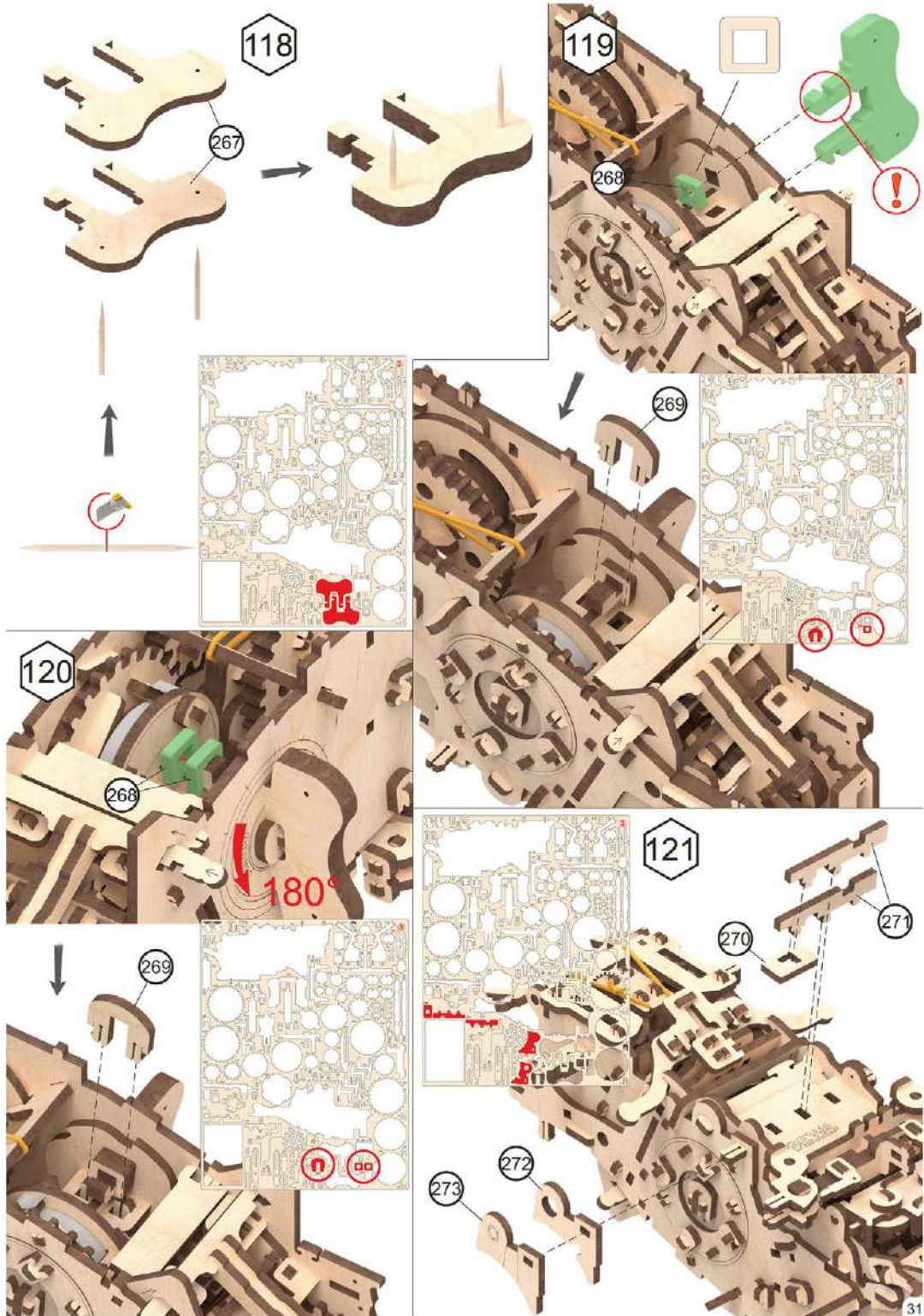

122

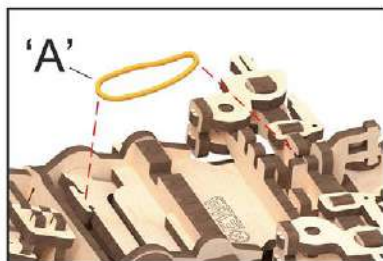

123

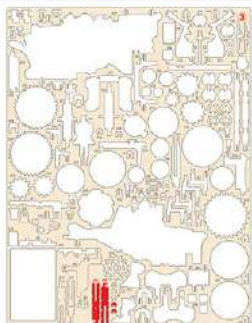
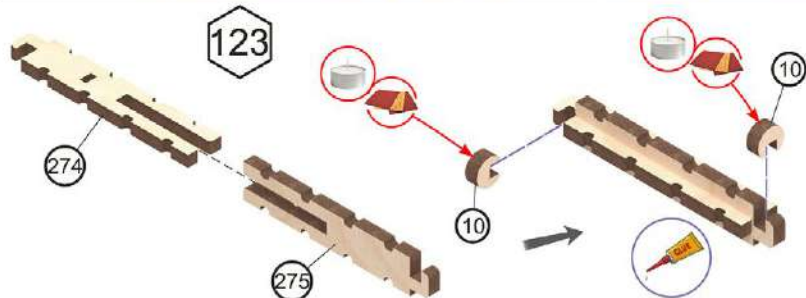

124

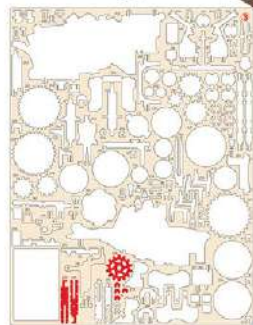
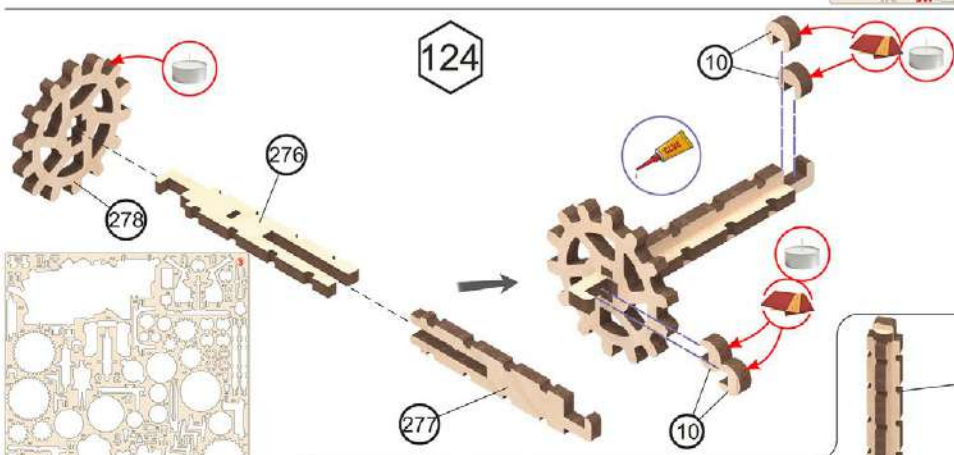

125

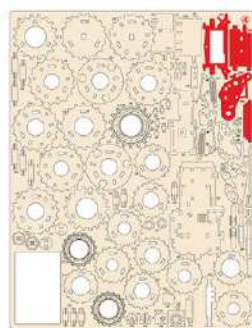
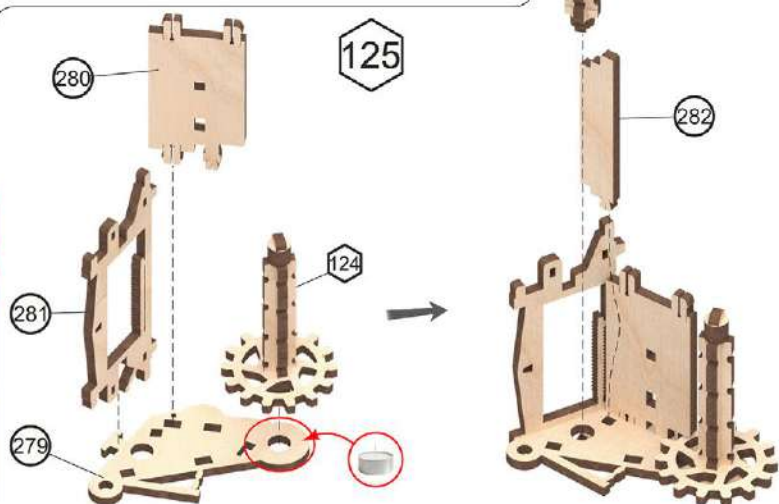



126

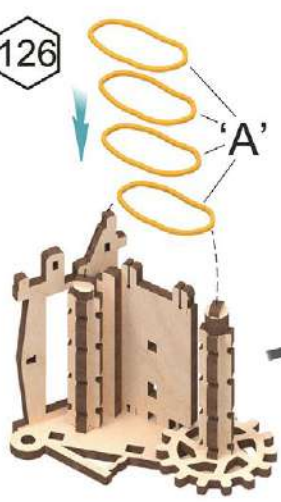

127

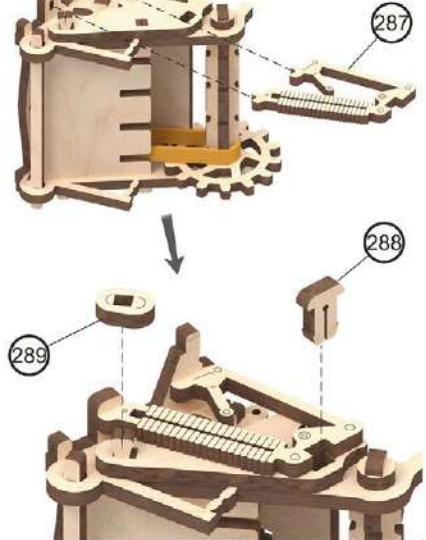
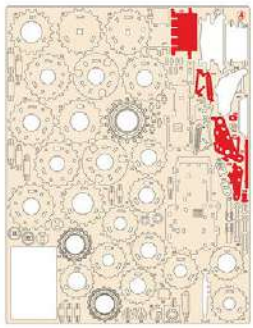
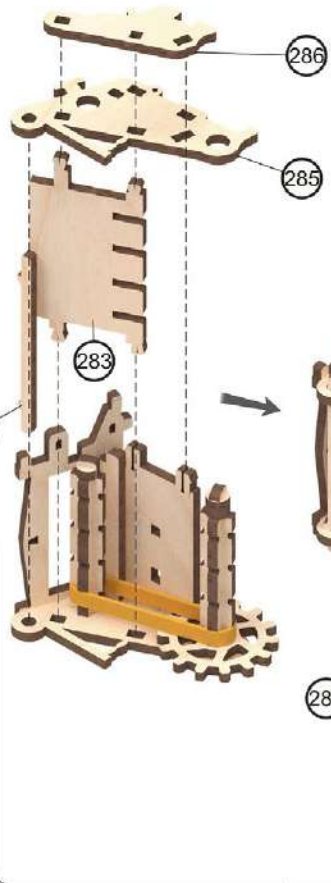
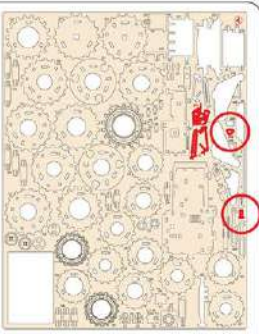

128

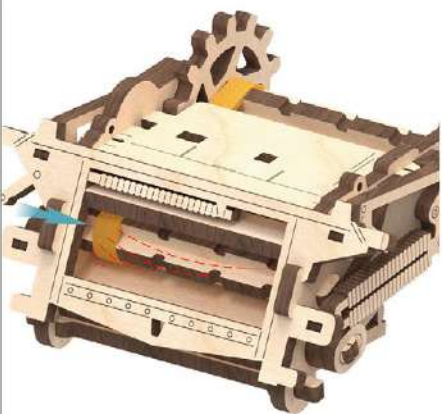

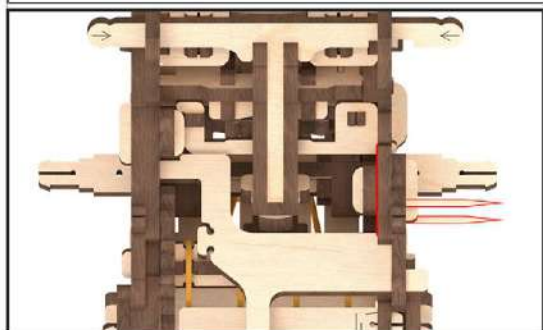
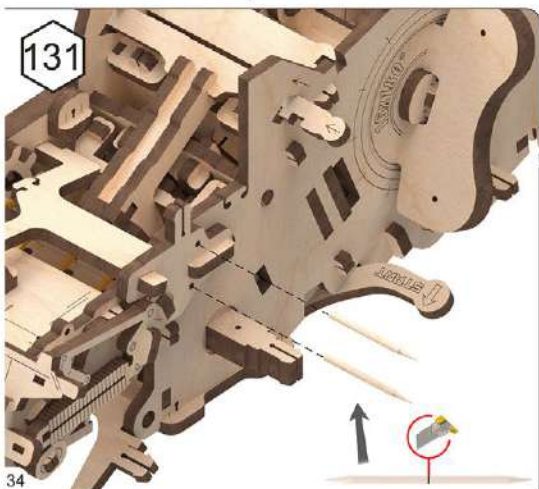
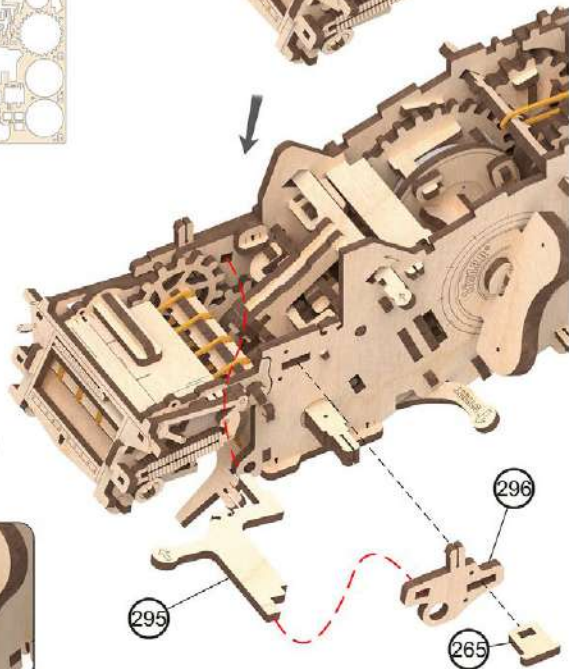
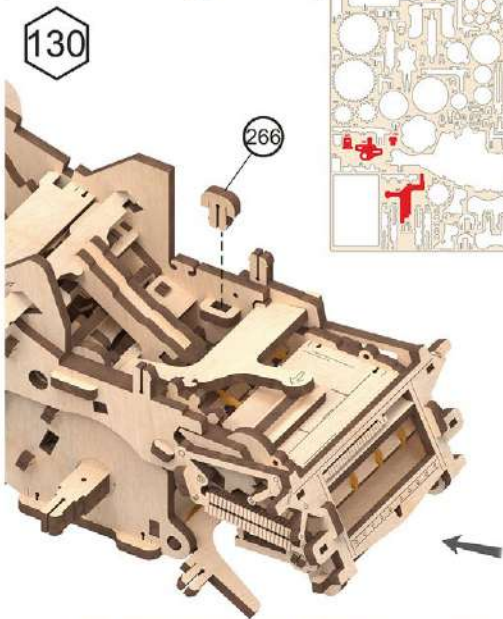
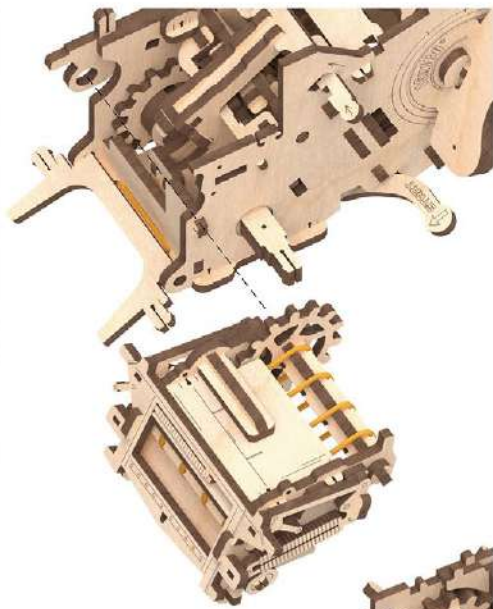
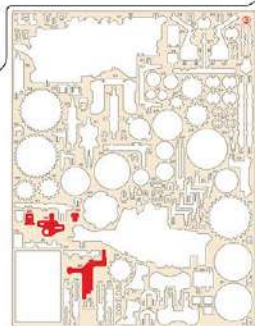
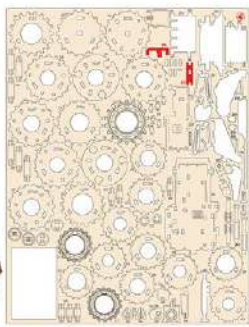
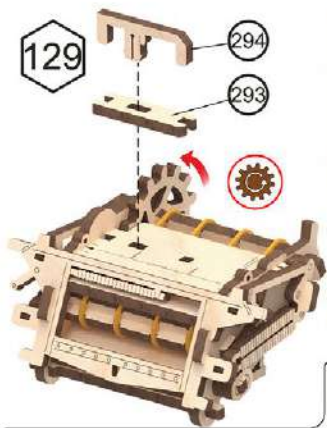

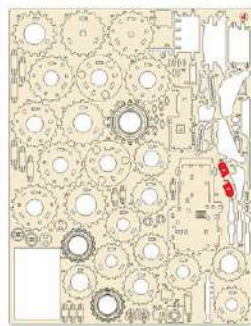
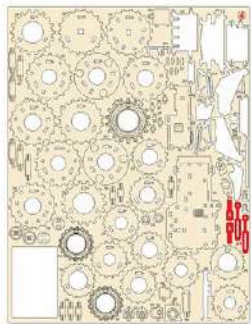
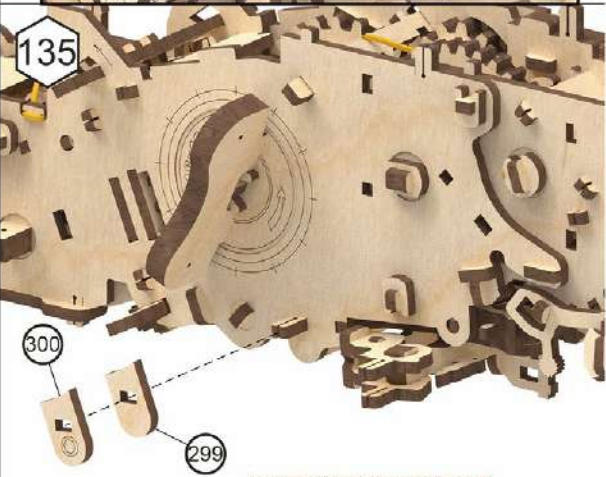
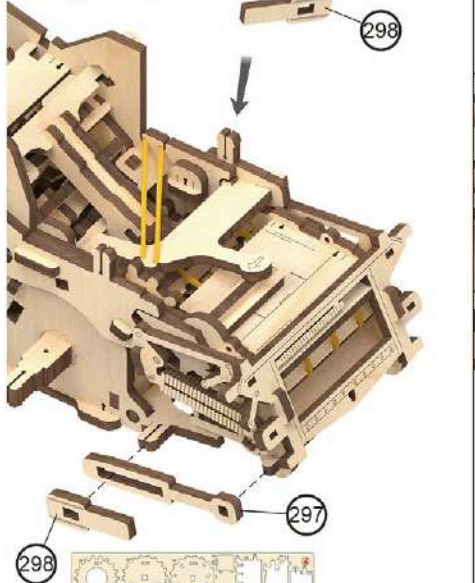
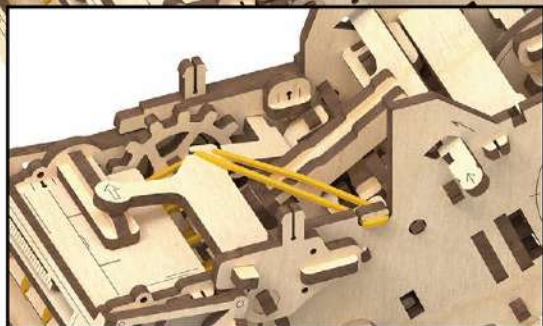
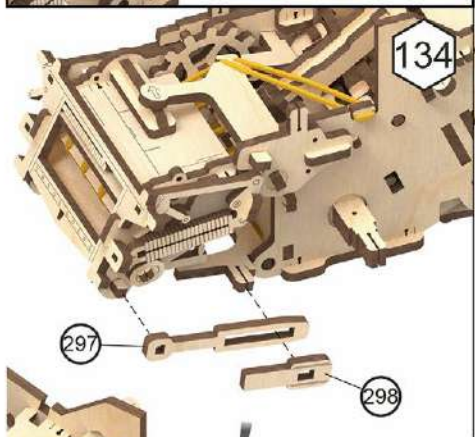
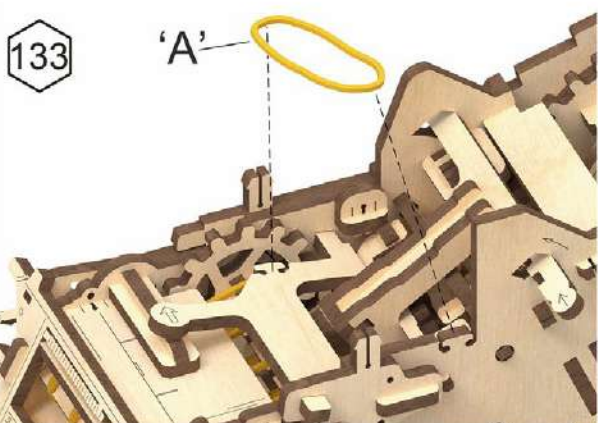
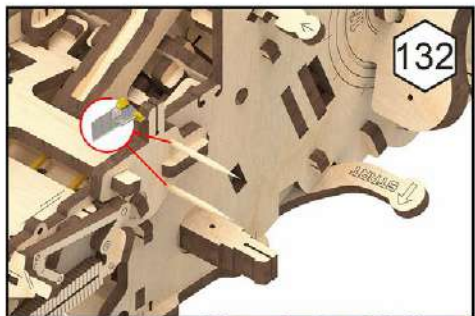

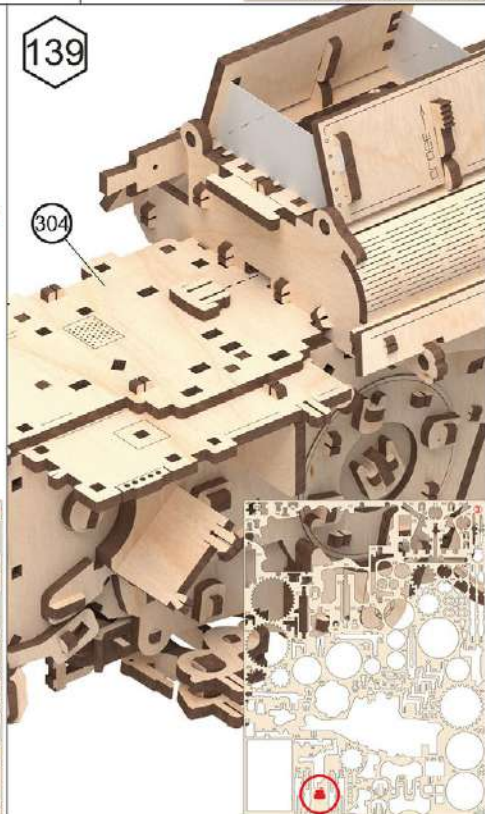
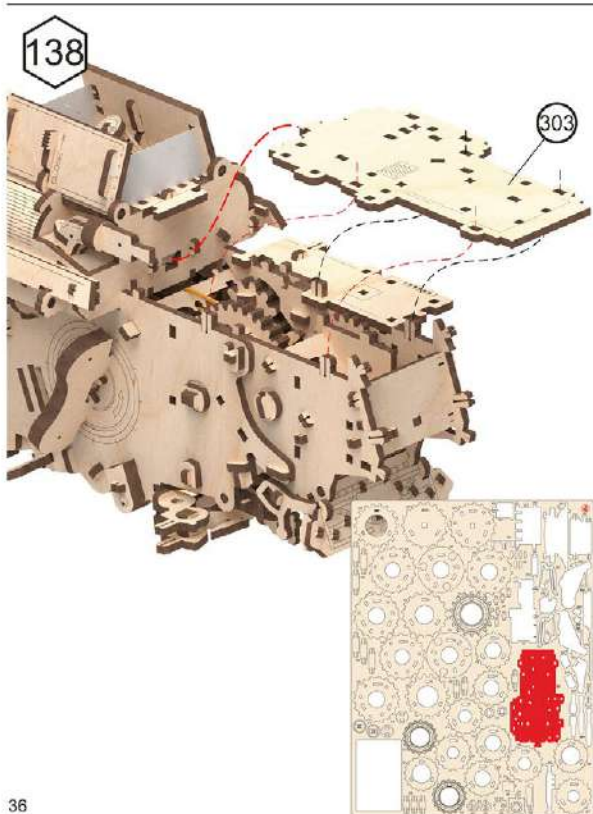
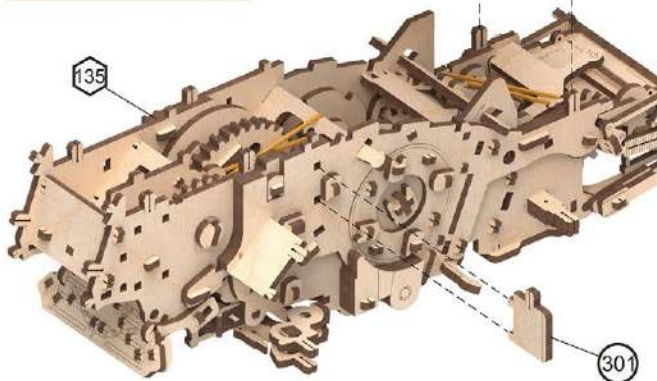
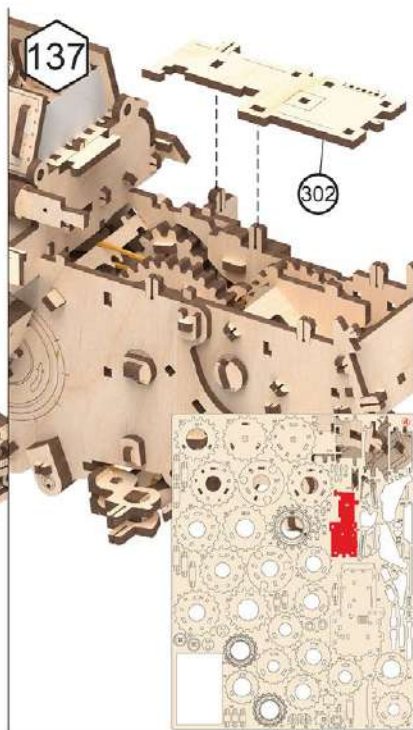
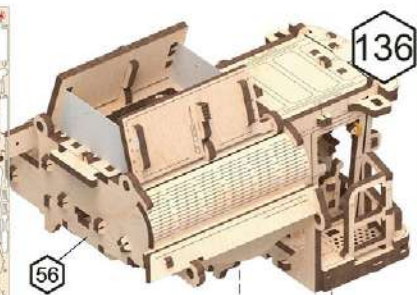
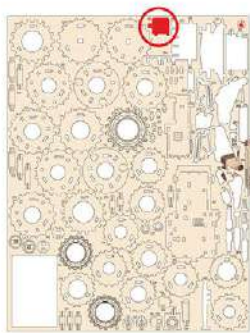

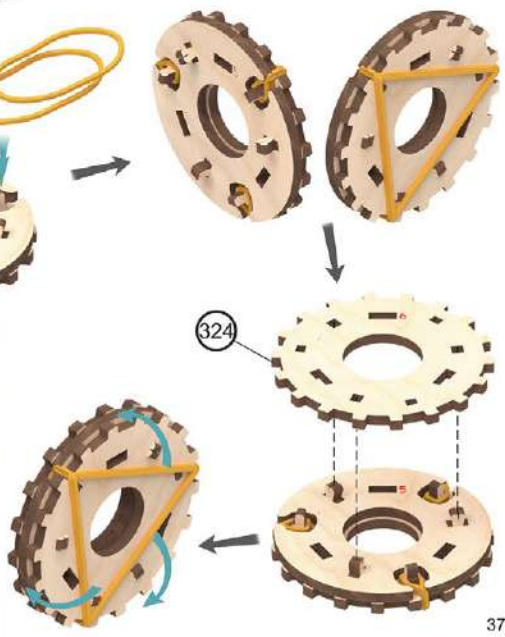
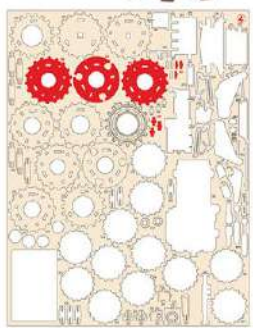
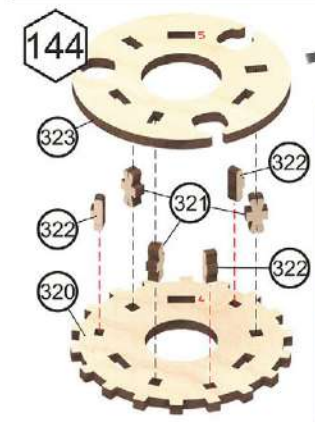
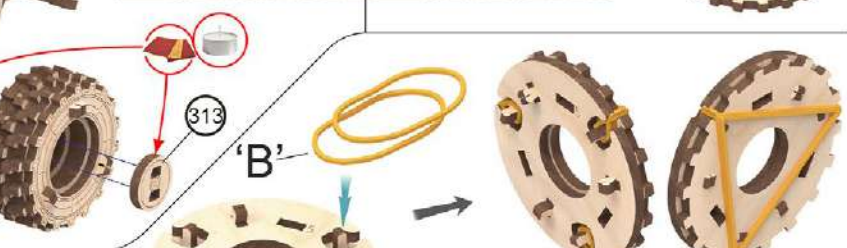
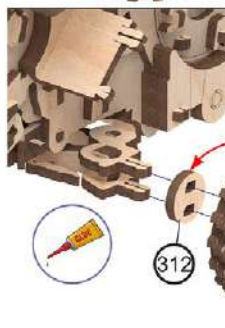
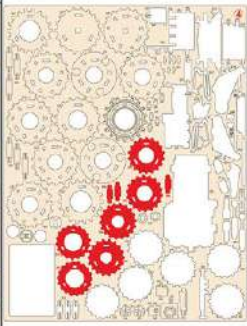
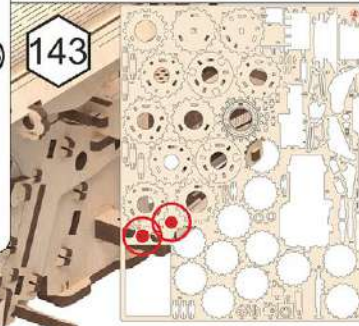
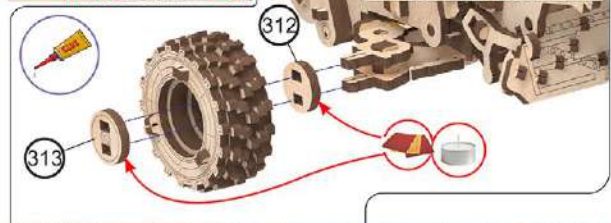
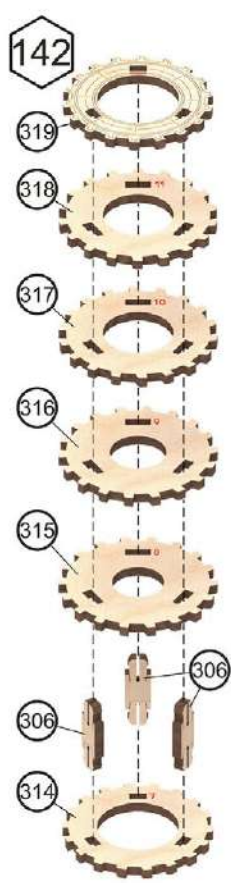
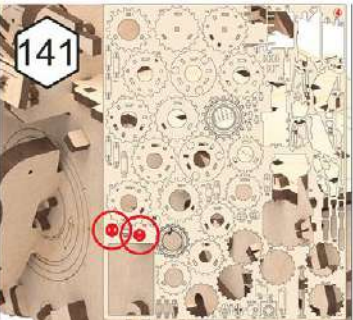
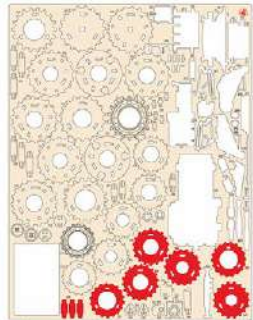
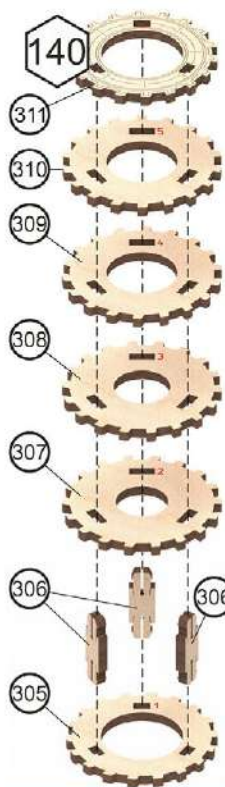

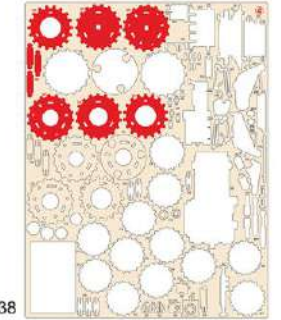
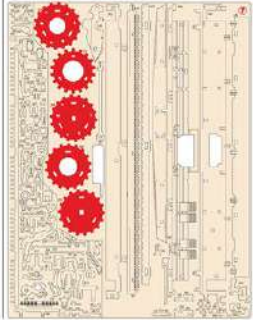
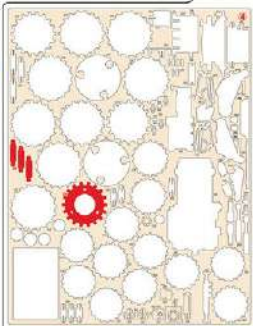
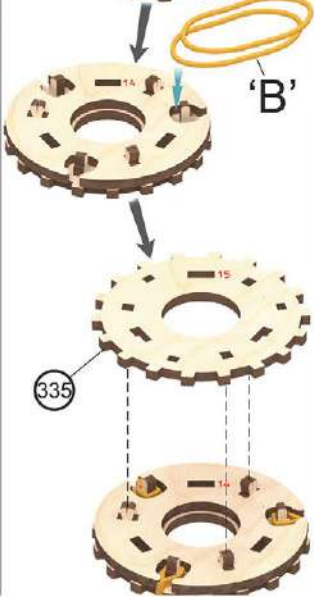
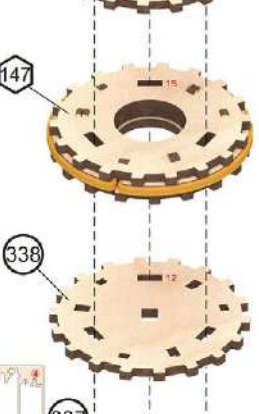
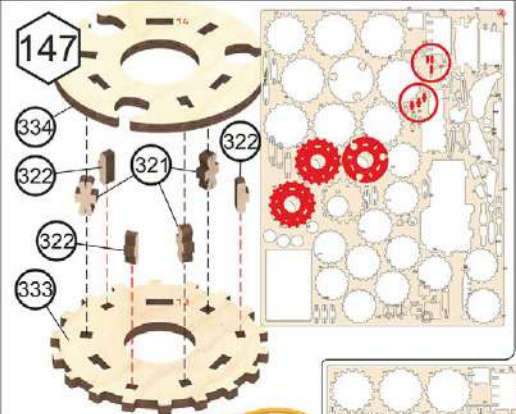
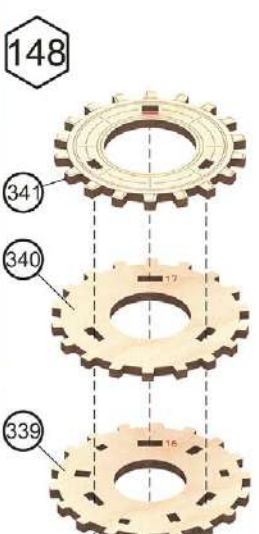
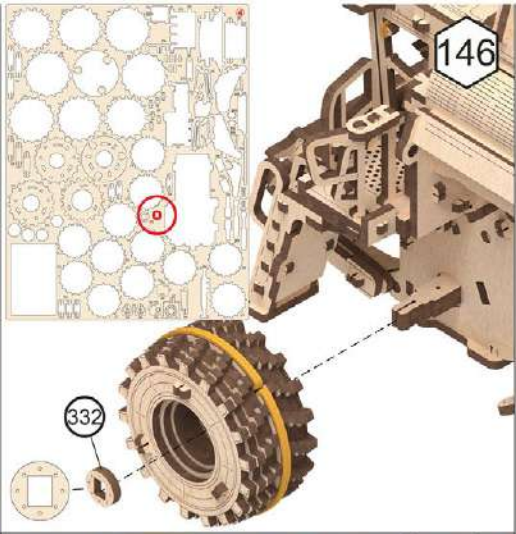
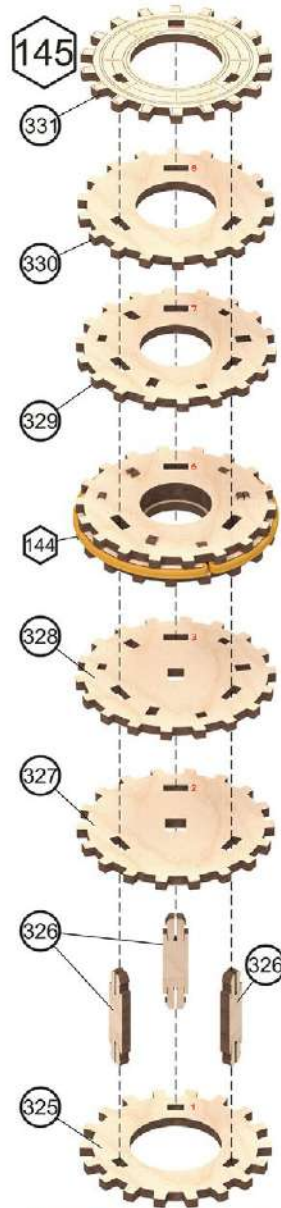

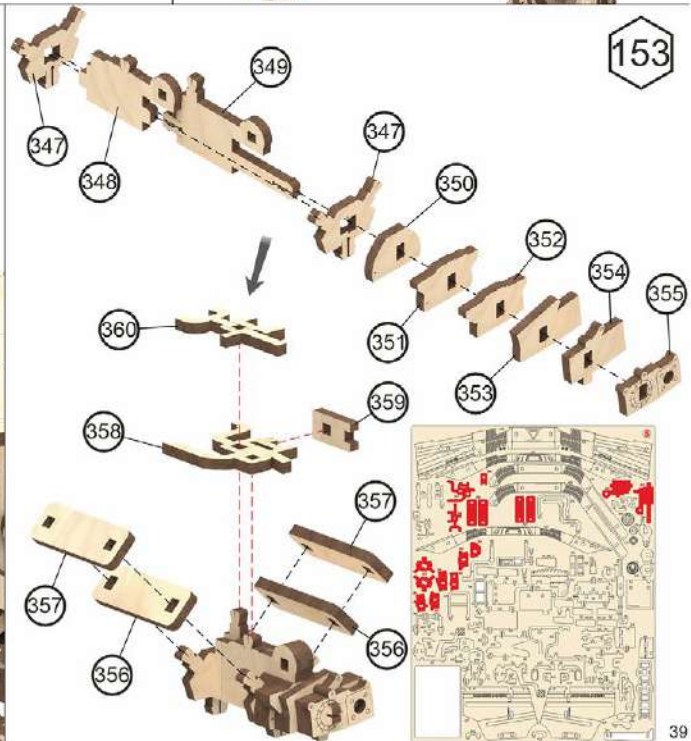
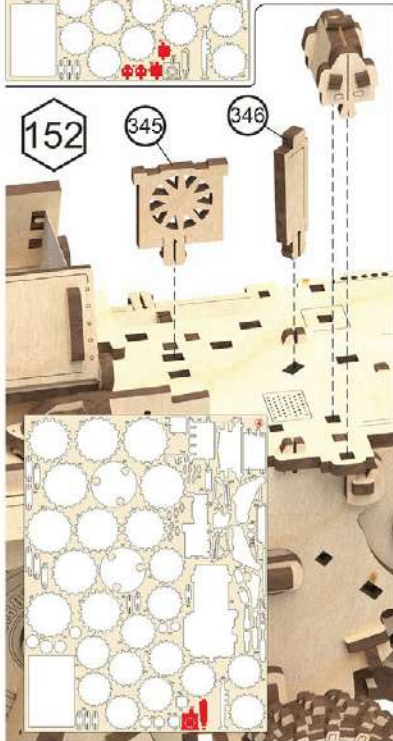
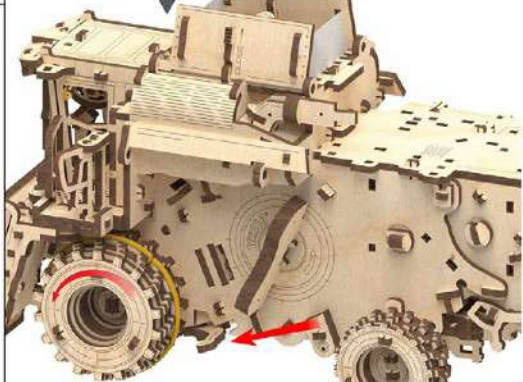
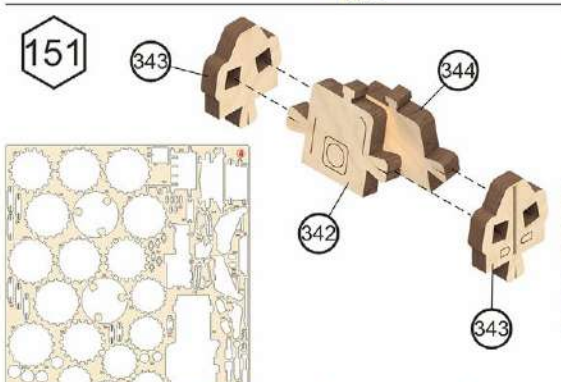
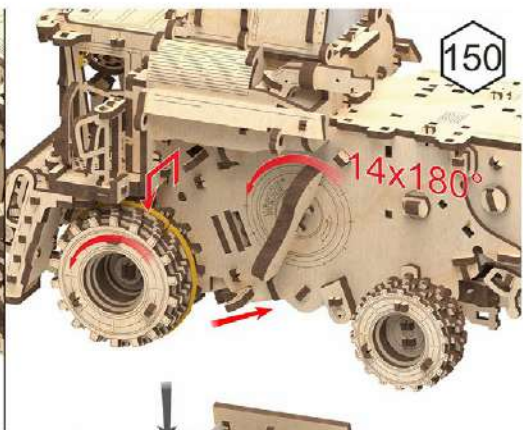
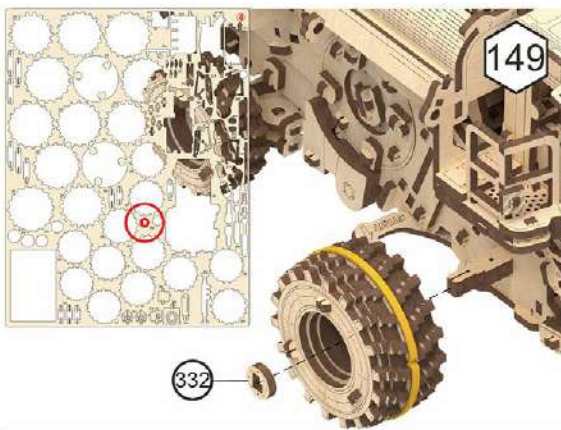

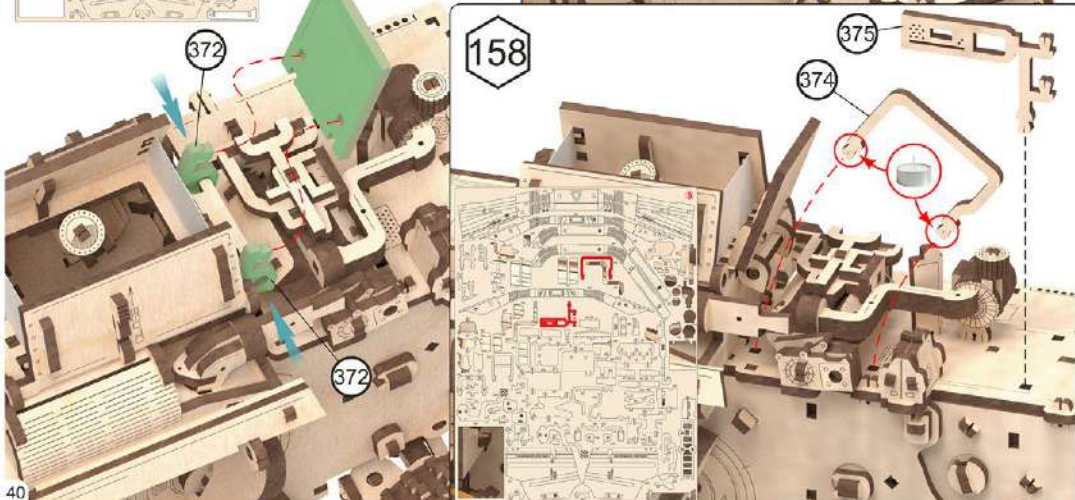
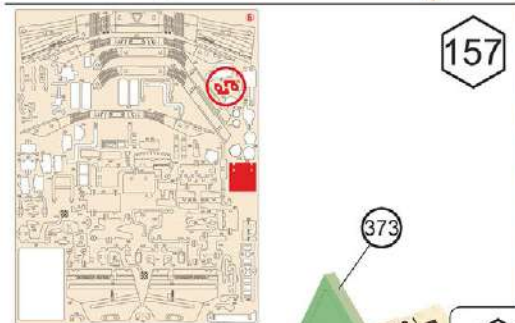
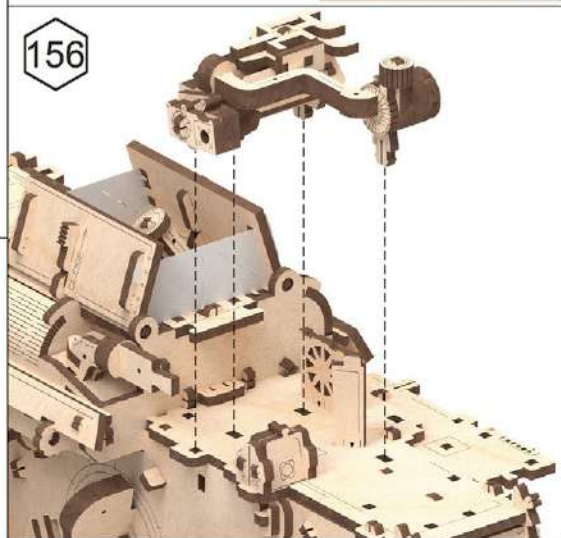
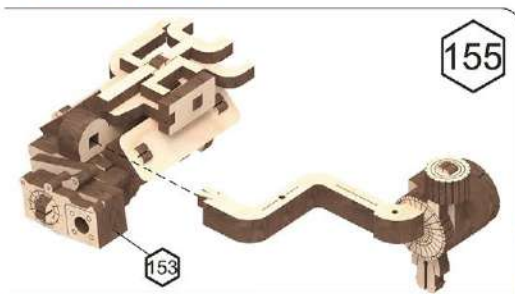
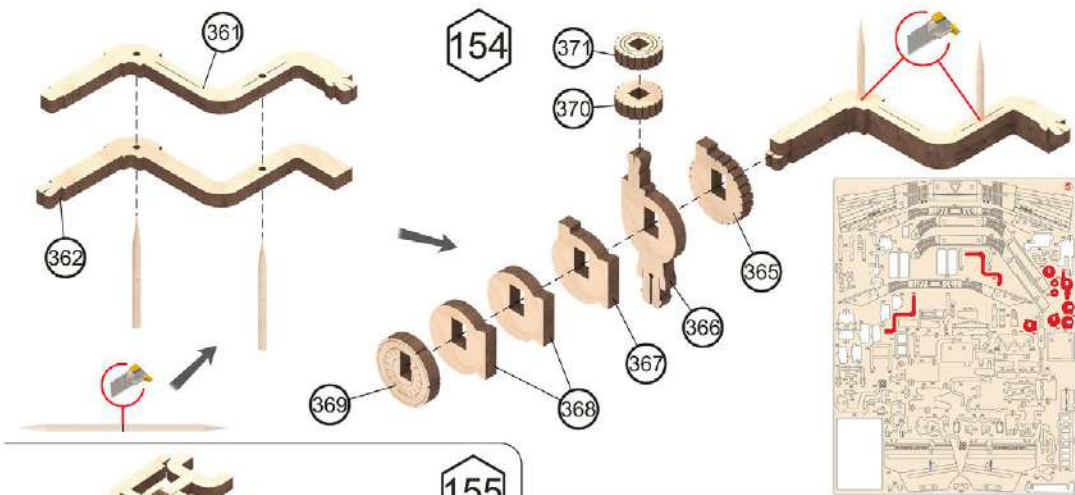



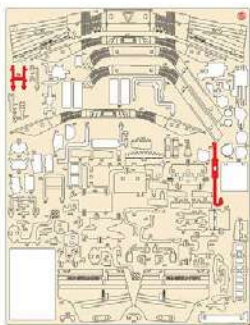

159

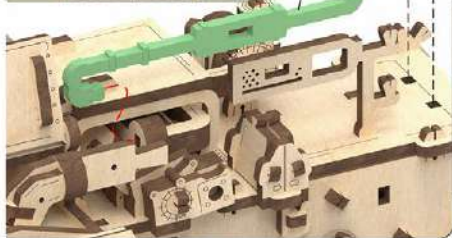

160

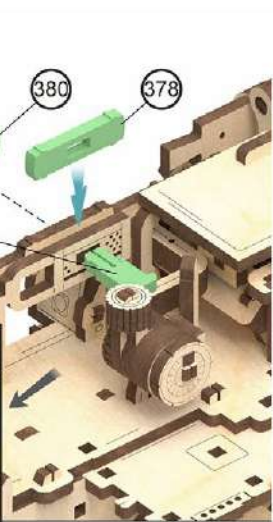

161

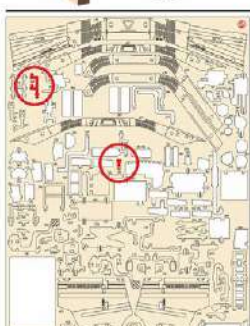
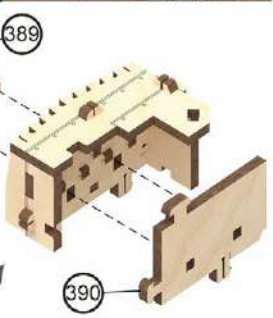
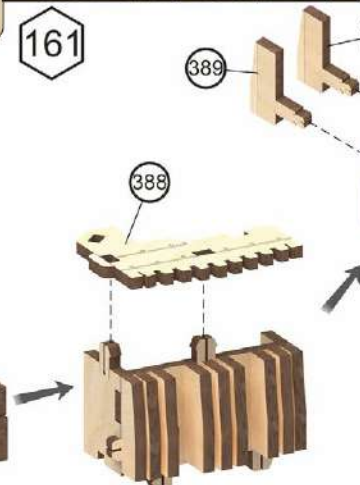
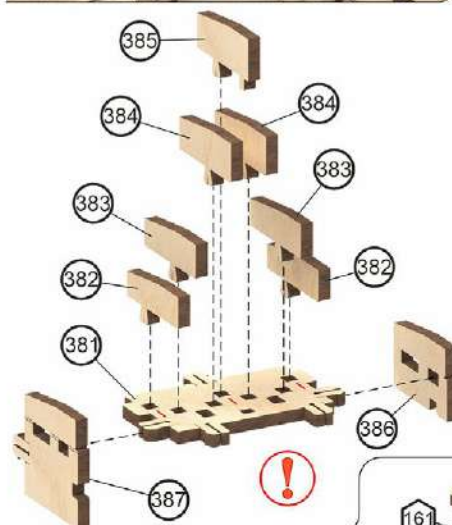

161

162

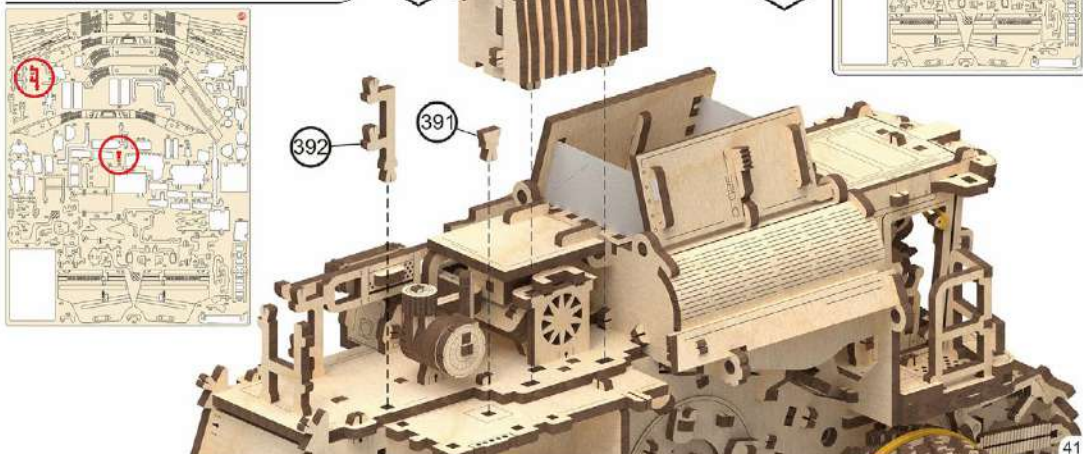

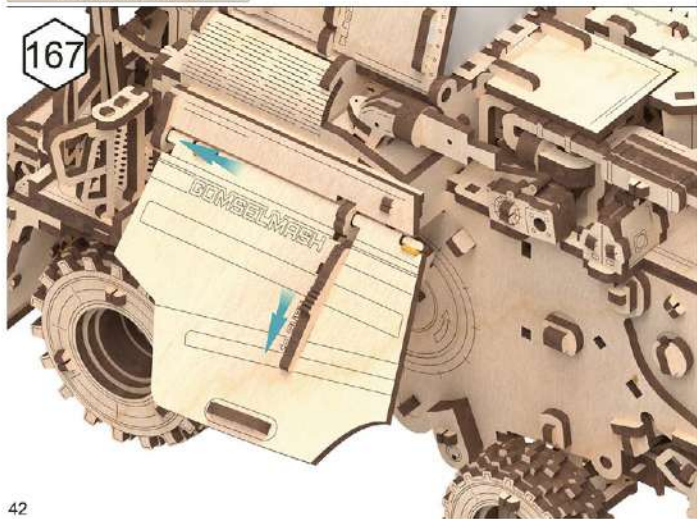
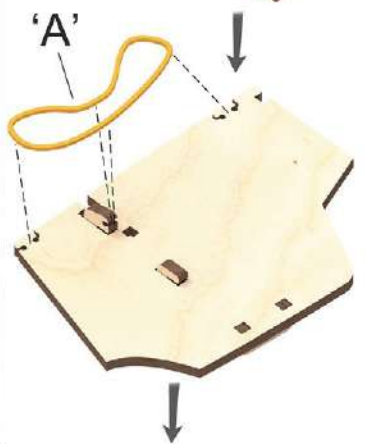
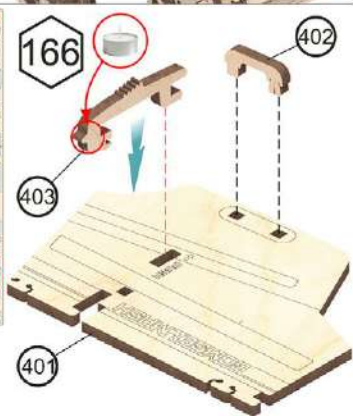
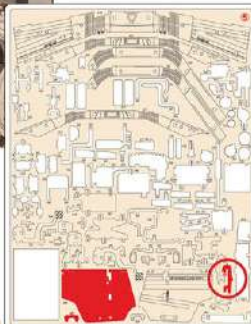
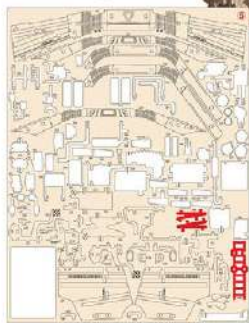
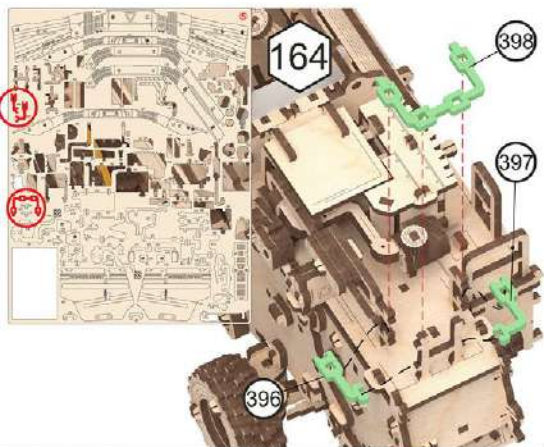
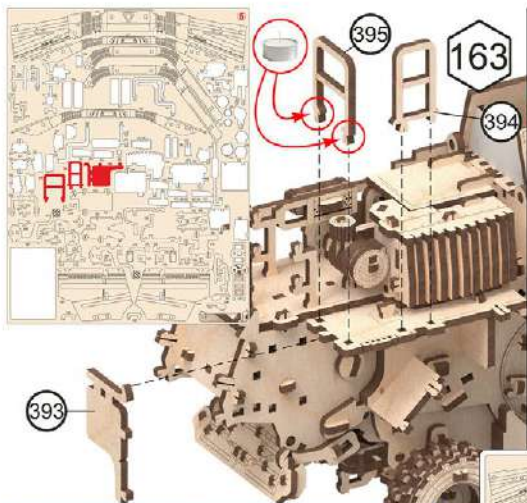

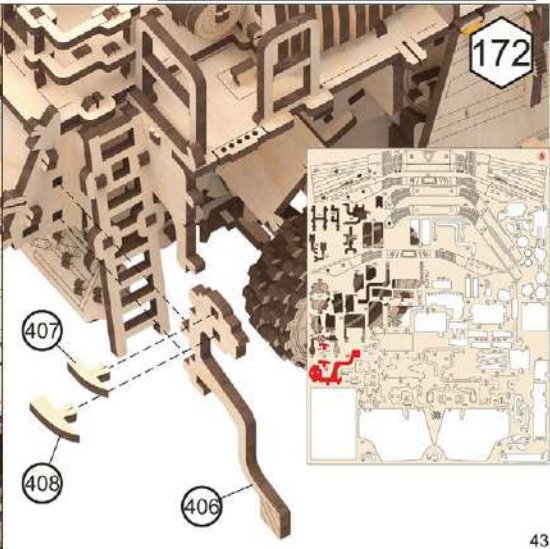
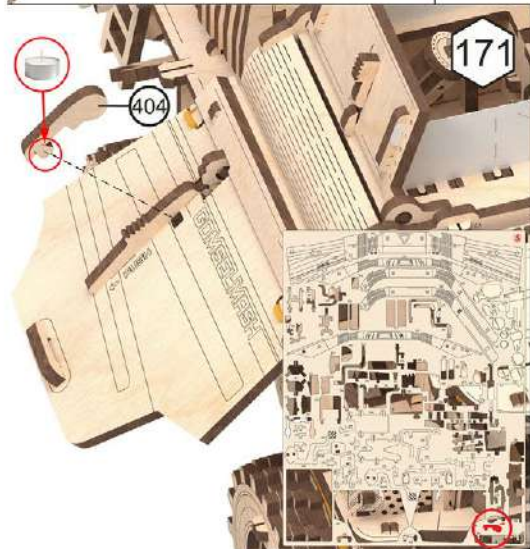
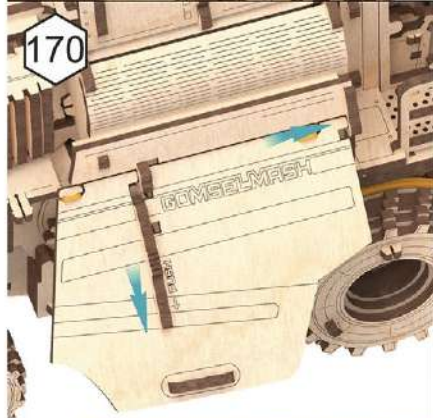
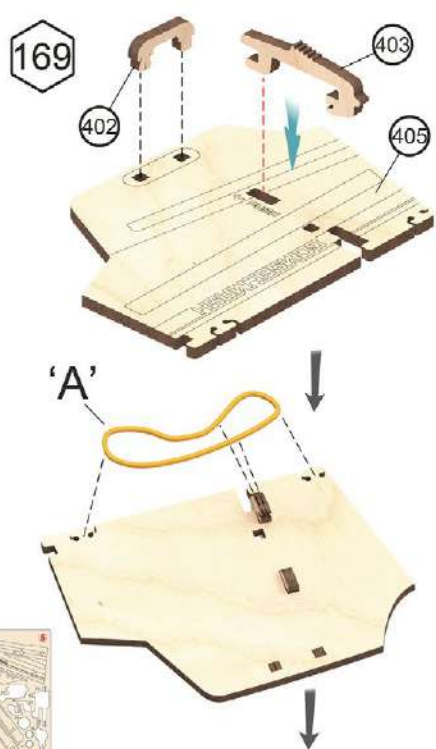
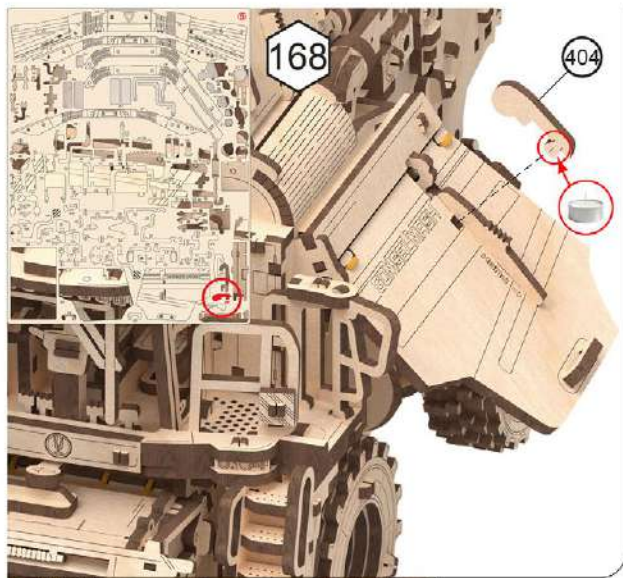

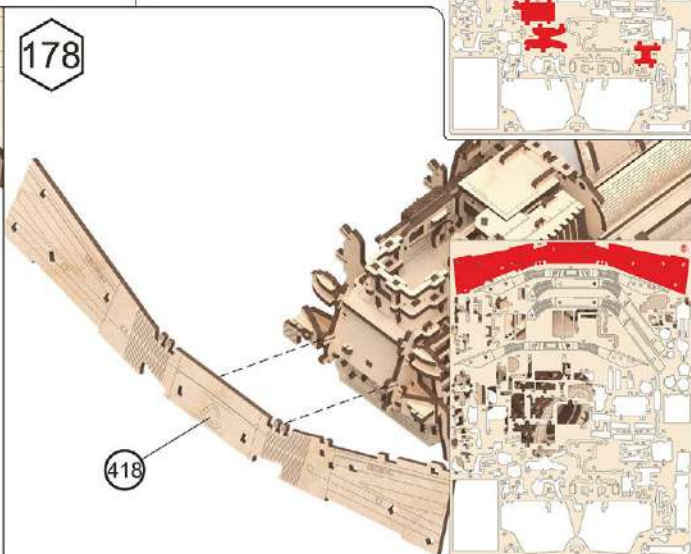
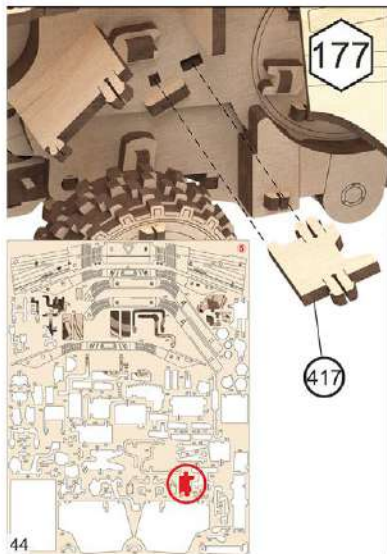
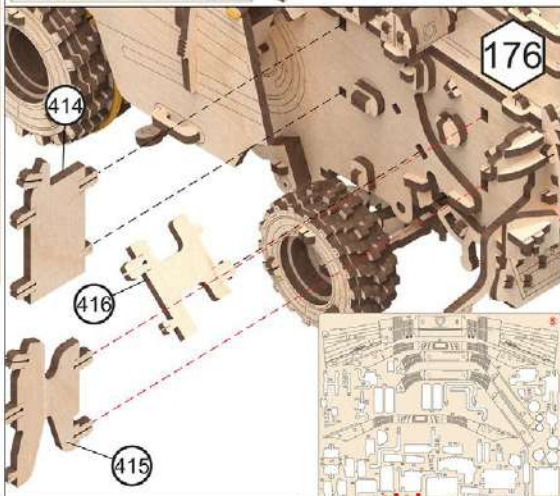
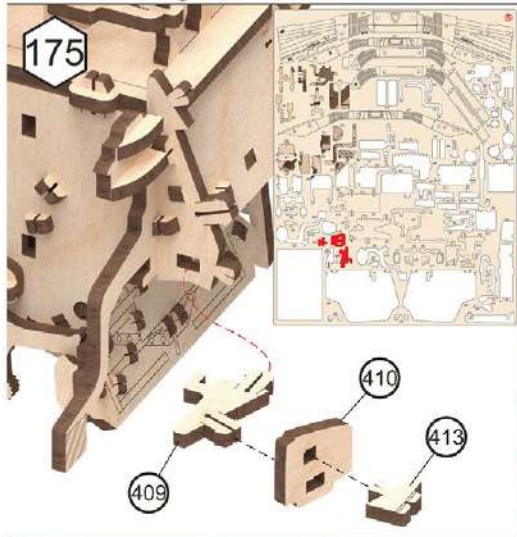
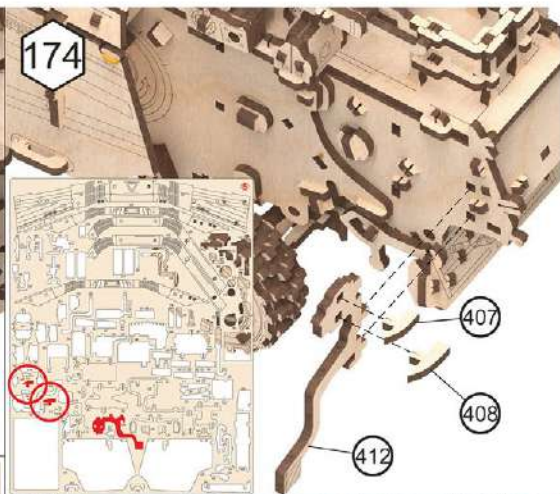
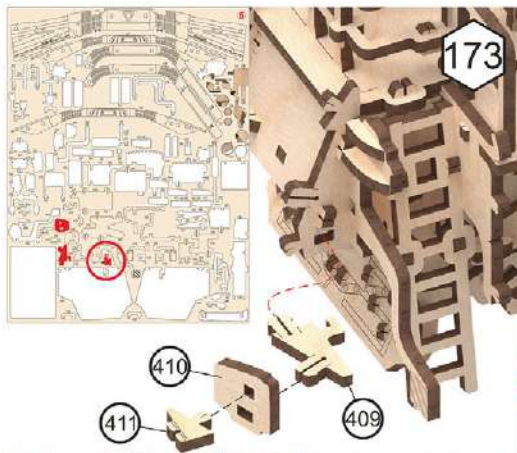

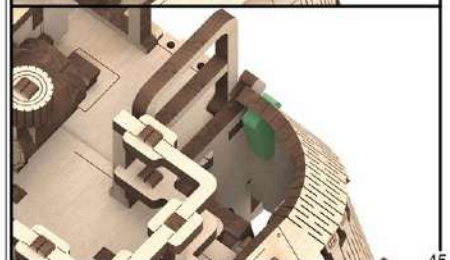
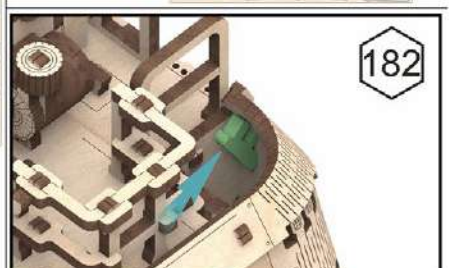
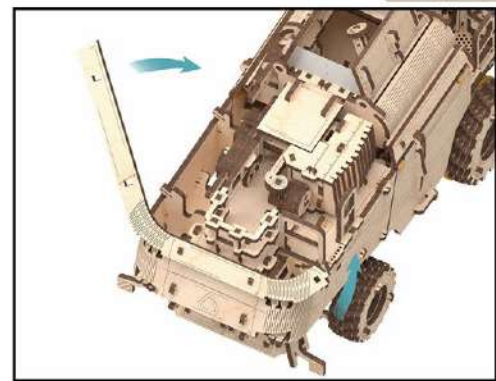
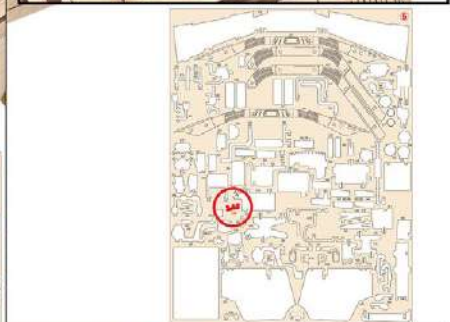
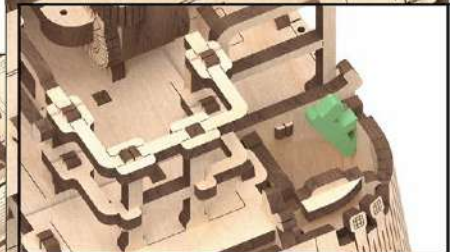
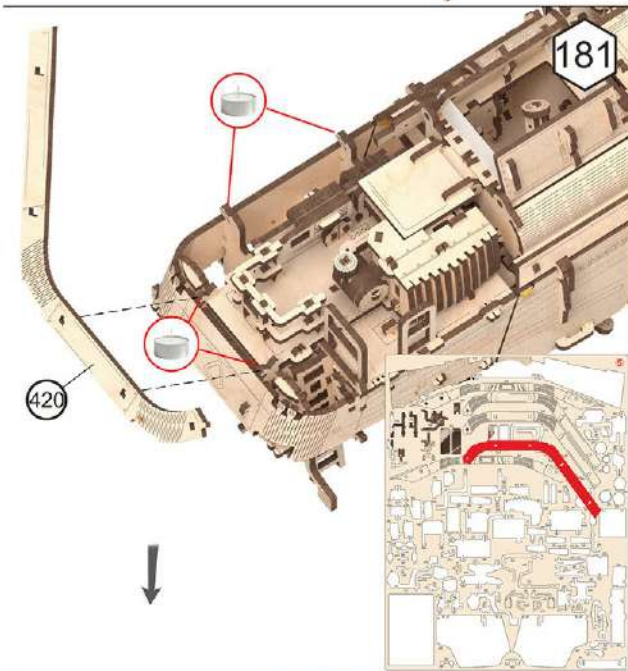
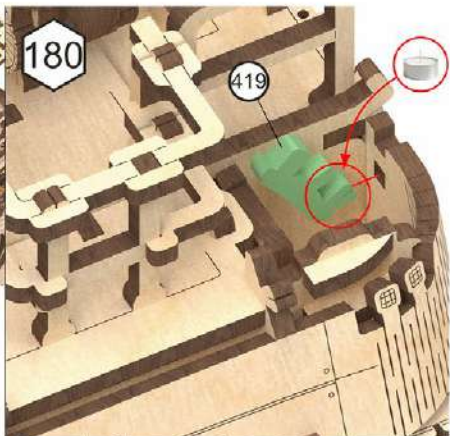
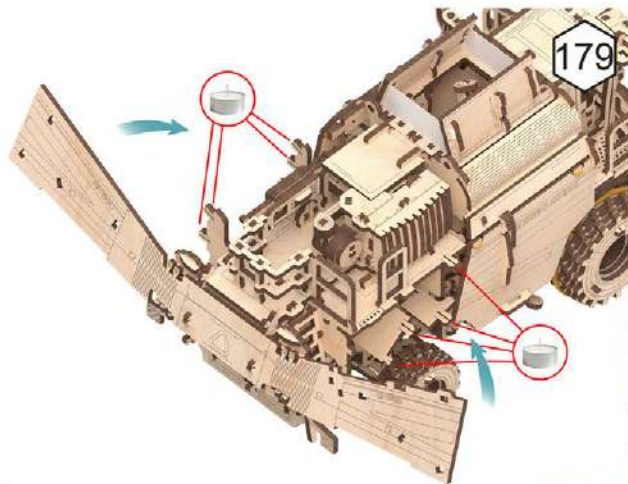

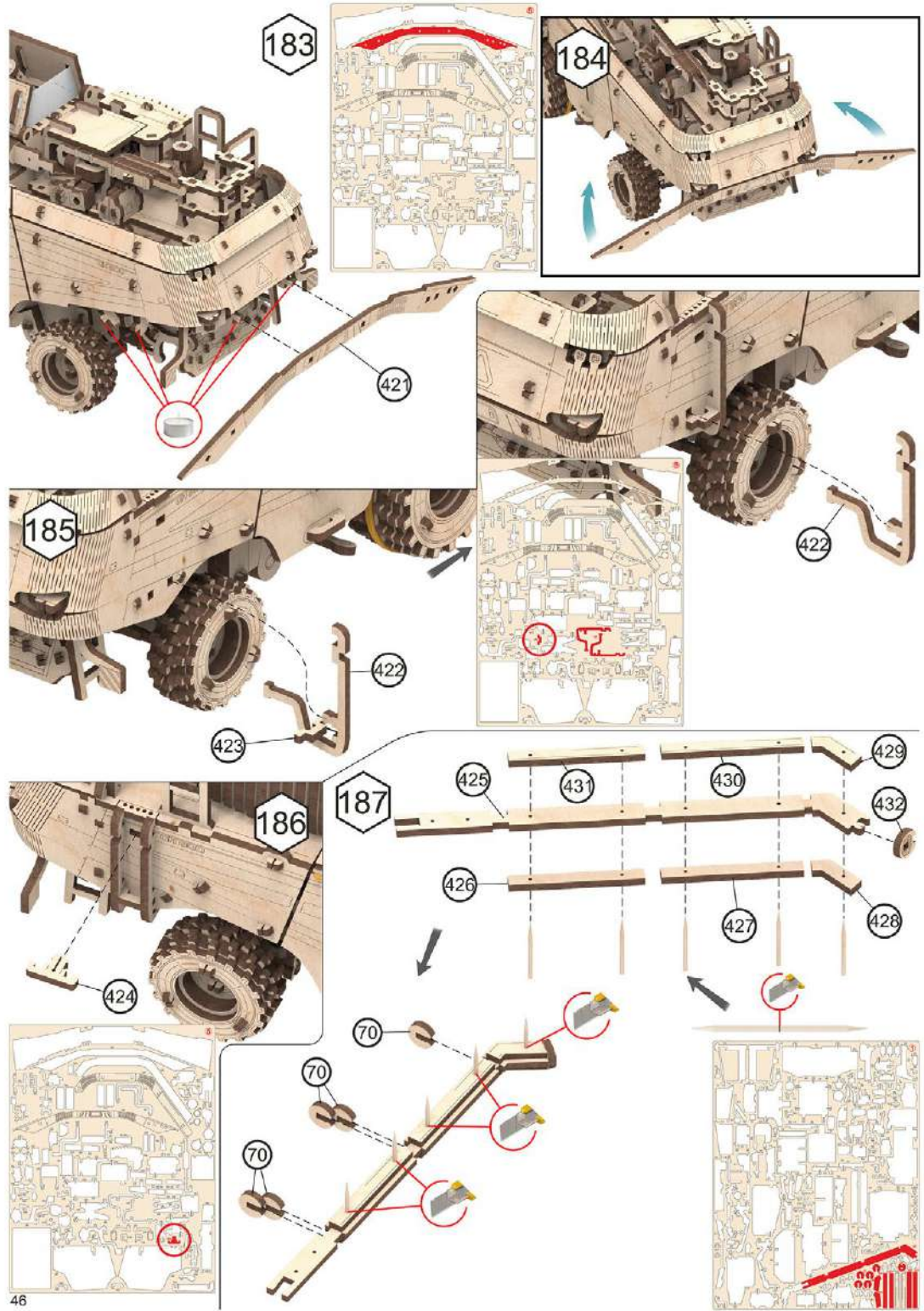

188

433

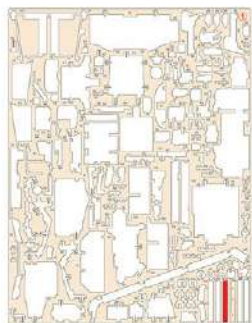

189

434

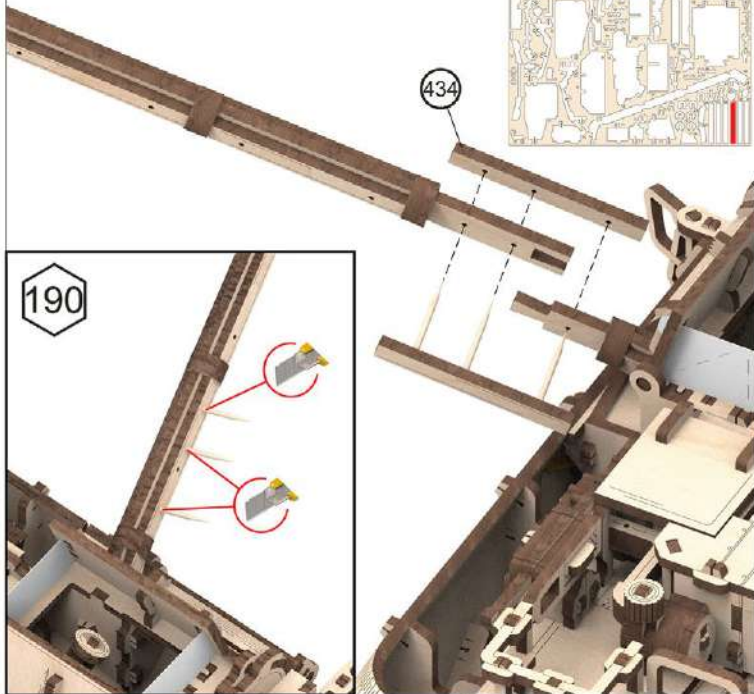

190

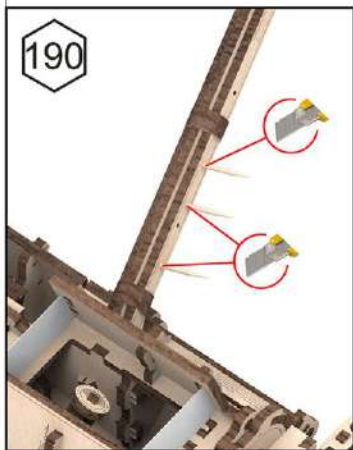

191

436

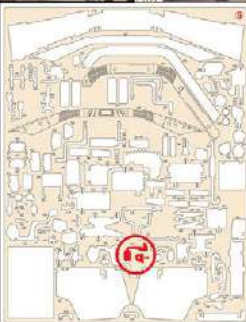
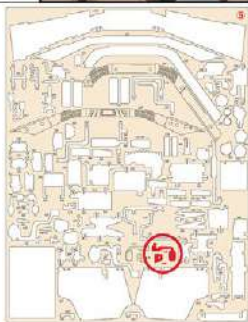
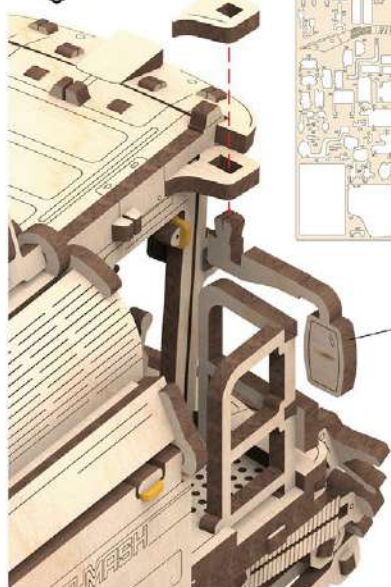

192

438

437

