



**LIGHT^{MY}
BRICKS**



**LEGO[®] CHRISTMAS TREE 2-IN-1
#40573 LIGHT KIT
INSTALLATION GUIDE**

Light My Bricks



LEGO® CHRISTMAS TREE 2-IN-1 40573 INSTALLATION GUIDE

Hi There!

We're here to help you get started on the LEGO®

Christmas Tree 2-In-1 40573 Light Kit.

This PDF details the instructions for the LED light kit only.

If you run into any issues, please refer to the troubleshooting section towards the end of this guide.

Have fun and enjoy!

INSTALLATION GUIDE





PACKAGE CONTENTS:



- 1x Large Warm White 30cm Bit Light
- 2x Red 30cm Bit Light
- 2x Yellow 30cm Bit Light
- 2x Green 30cm Bit Light
- 2x Blue 30cm Bit Light
- 2x Pink 30cm Bit Light
- 8x Micro White 15cm Bit Light
- 5x Micro White 30cm Bit Light *



- 1x 6-Port Expansion Board
- 1x 12-Port Expansion Board
- 1x Micro 4-Port Expansion Board
- 1x Micro 8-Port Expansion Board
- 1x Flicker Effects Board



- 2x 5cm Connecting Cable
- 2x 15cm Connecting Cable



- 2x USB Power Cable
(Power Source not Included)

ASSORTED BRICKS:

- 2x Round Plate 1x1 - Trans Clear
- 4x Round Brick 1x1 - Green
- 10x Round Brick 1x1 - Trans Clear

* Indicates components which include spares

Contents

Before You Begin	5
Blueprints	10
“Large Tree” Instructions	12
“Medium & Small Tree” Instructions	51
Final Product	91
Troubleshooting	92
Contact	96

Before You Begin

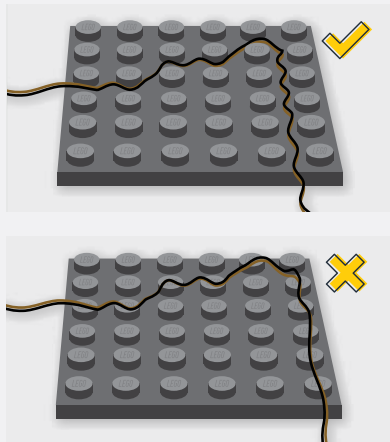

Laying cables in between and underneath bricks

Cables can fit in between and underneath LEGO® bricks, plates, and tiles providing they are laid correctly between the LEGO® studs. Do NOT forcefully join LEGO® together around cables; instead ensure they are laying comfortably in between each stud.

CAUTION: Forcing LEGO® to connect over a cable can result in damaging the cable and light.



Connecting Cable Connectors To Expansion Boards

Take extra care when inserting connectors to ports of Expansion Boards. Connectors can be inserted only one way. With the expansion board facing up, look for the soldered “=” symbol on the left side of the port. The connector side with the wires exposed should be facing toward the soldered “=” symbol as you insert into the port. If a plug won’t fit easily into a port connector, do not force it.

Incorrectly inserting the connector can result in bent pins inside the port or possible overheating of the expansion board when connected.

Before You Begin



Connecting Cable Connectors To Strip Lights

Take extra care when inserting connectors to ports on the Strip Lights. Connectors can be inserted only one way. With the Strip Light facing up, ensure the side of the connector with the wires exposed is facing down. If a plug won't fit easily into a port connector, don't force it. Doing so will damage the plug and the connector.



Connecting Micro Cable Connectors To Micro Expansion Board Ports

Take extra care when inserting the micro connectors to micro ports of Micro Expansion Boards. Connecting Micro Bit Lights to Micro Expansion Boards is similar to connecting lights and cables to Strip Lights. With the expansion board facing up, ensure the side of the connector with the wires exposed is facing down. If a plug won't fit easily into a port connector, do not force it. Use your fingernail to push the plastic part of the connector to the micro port.

Before You Begin

Installing Bit Lights Under Lego® Bricks And Plates

When installing Bit Lights under LEGO® pieces, ensure they are placed the correct way up (Yellow LED component exposed). You can either place them directly on top of LEGO® studs or in between.

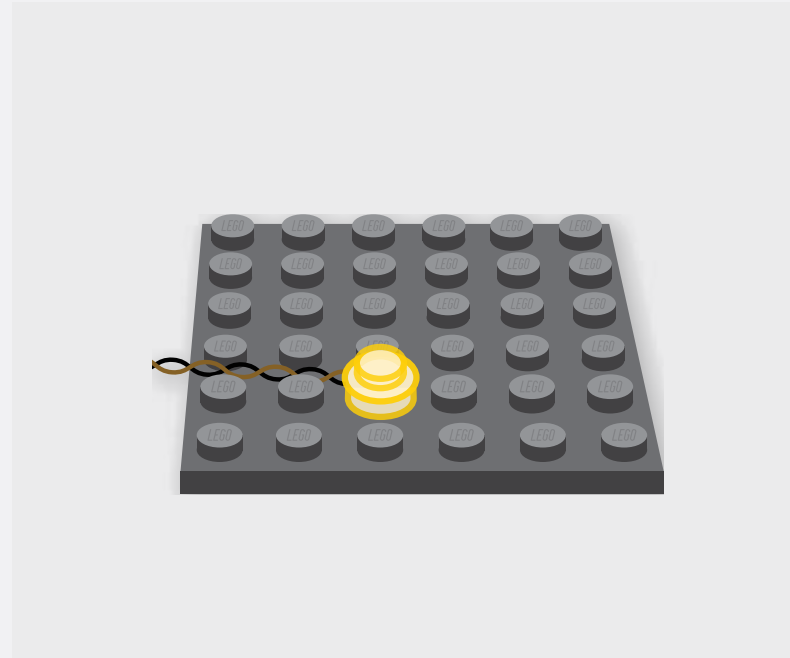

USER GUIDE



**LIGHT MY
BRICKS**

If you are experiencing issues with your Light My Bricks set, watch our troubleshooting video or read on for a list of common causes to help you troubleshoot.



Wenn Sie Probleme mit Ihrem Light My Bricks-Set haben, sehen Sie sich unser Video zur Fehlerbehebung an oder lesen Sie die Auflistung der häufigsten Ursachen, die Ihnen bei der Fehlersuche helfen hier.



Si vous rencontrez des problèmes avec votre kit Light My Bricks, regardez notre vidéo de dépannage ou consultez la liste des causes les plus fréquentes pour vous aider à les résoudre ici.



Se si verificano problemi con il set Light My Bricks, guardare il nostro video per la risoluzione dei problemi o leggere l'elenco delle cause più comuni per la risoluzione dei problemi qui.

Before You Begin

The Symbols Used In This Guide

When going through the following guide you will come across symbols and formats that will assist with the installation of your light kit. Take notice of them as each has a specific purpose.

Light Kit Component

This is the most important image format as it indicates which part to use from the Light Kit. Make sure you pay close attention to which part is shown.

White 30cm Bit Light



Connect

Used when you need to connect a LEGO piece or LMB component.



Disconnect

Used when you need to remove a LEGO piece/ section or LMB component.



Directional

Used to show where to route cables, place components, or move them.



Bend/Pivot

Used when a component needs to be bent, or part folded or pivoted.



Turn/ Flip

Will be found in the top left corner when the set needs to be rotated or flipped.



Twist/ Braid

Seen when a set of cables need to be grouped and twisted together.



Power On Test

Found at the end of a major step to test the lights. Will be located in the top left corner.



Note

Notes will be found alongside the instruction photos and explain what to do.



Before You Begin

Repeat Step

Repeat the previous step eg. Make a spotlight, then make a second spotlight.



Connect Focus

Used to highlight a hard to see area where a component is being connected.



Disconnect Focus

Used to highlight a hard to see area where a component is being disconnected.



General Focus

Used to highlight a hard to see area where a component needs to be acted on.



General Note

This is a sample note that is used anywhere in this guide. It will explain a difficult section where photos are hard to illustrate or easily confused.

Connect Note

The green coloured note is used when the topic focuses on a component being connected, like the shown Power Bank.

Disconnect Note

The red coloured note is used when the topic focuses on a component being disconnected or like here, the removed pieces.

NOTE

Take the 5cm Connecting Cable from the 4-Port Micro Expansion Board and route it into the "IN" port of the Flicker Effects Board

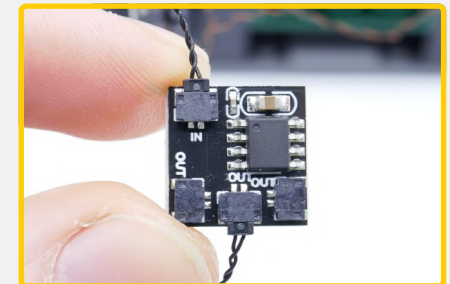

NOTE

Connect to a 5V USB Power Bank, 5V USB Wall Adaptor, or USB to AA Battery Pack (sold separately)



NOTE

You should have these parts left over that were removed from the LEGO set

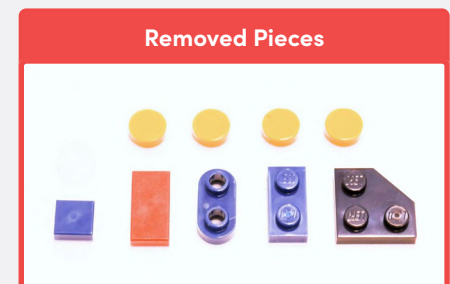



BLUEPRINT: Large Tree

Large Christmas Tree

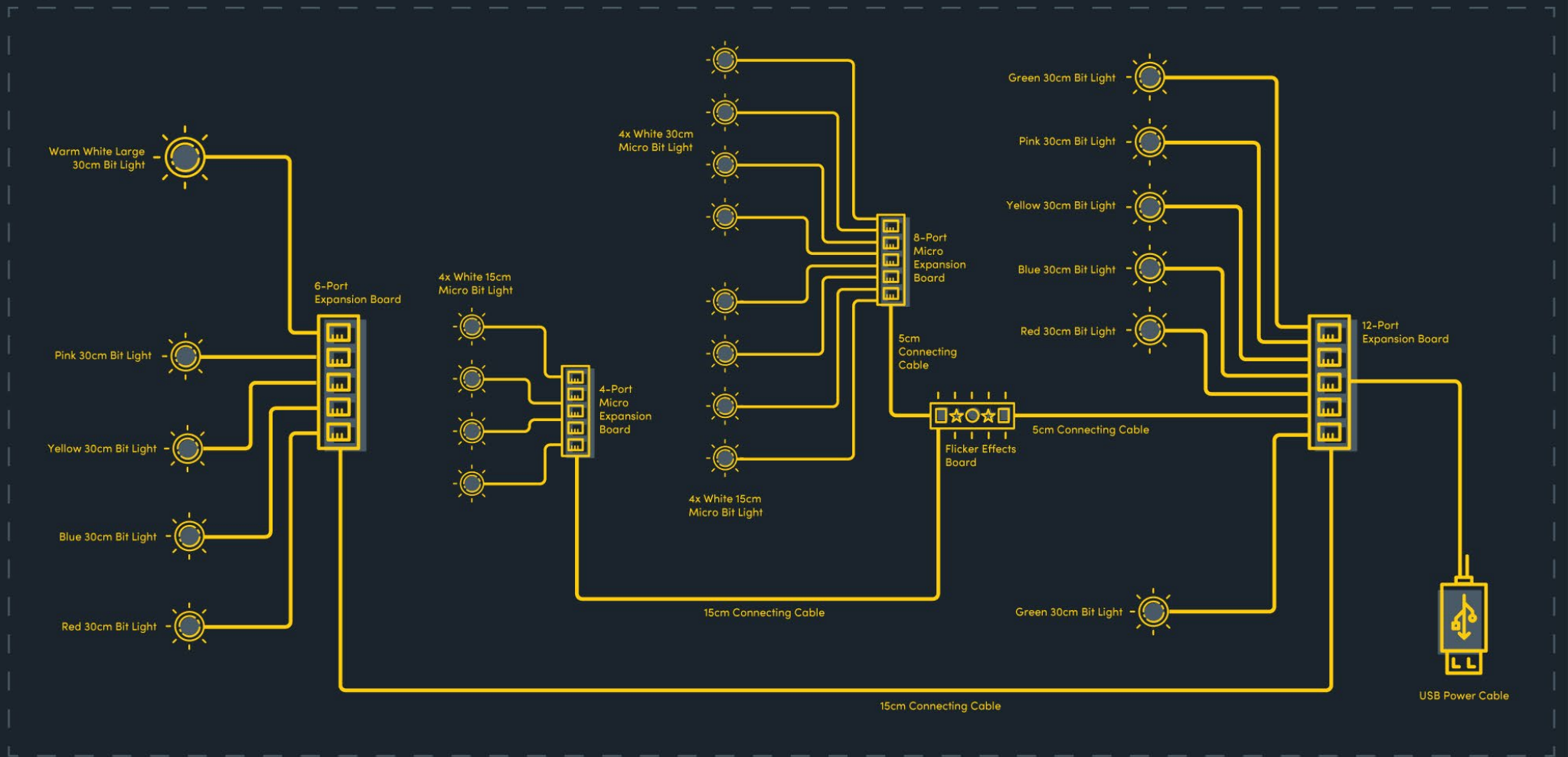



BLUEPRINT: Medium and Small Tree

Medium Christmas Tree

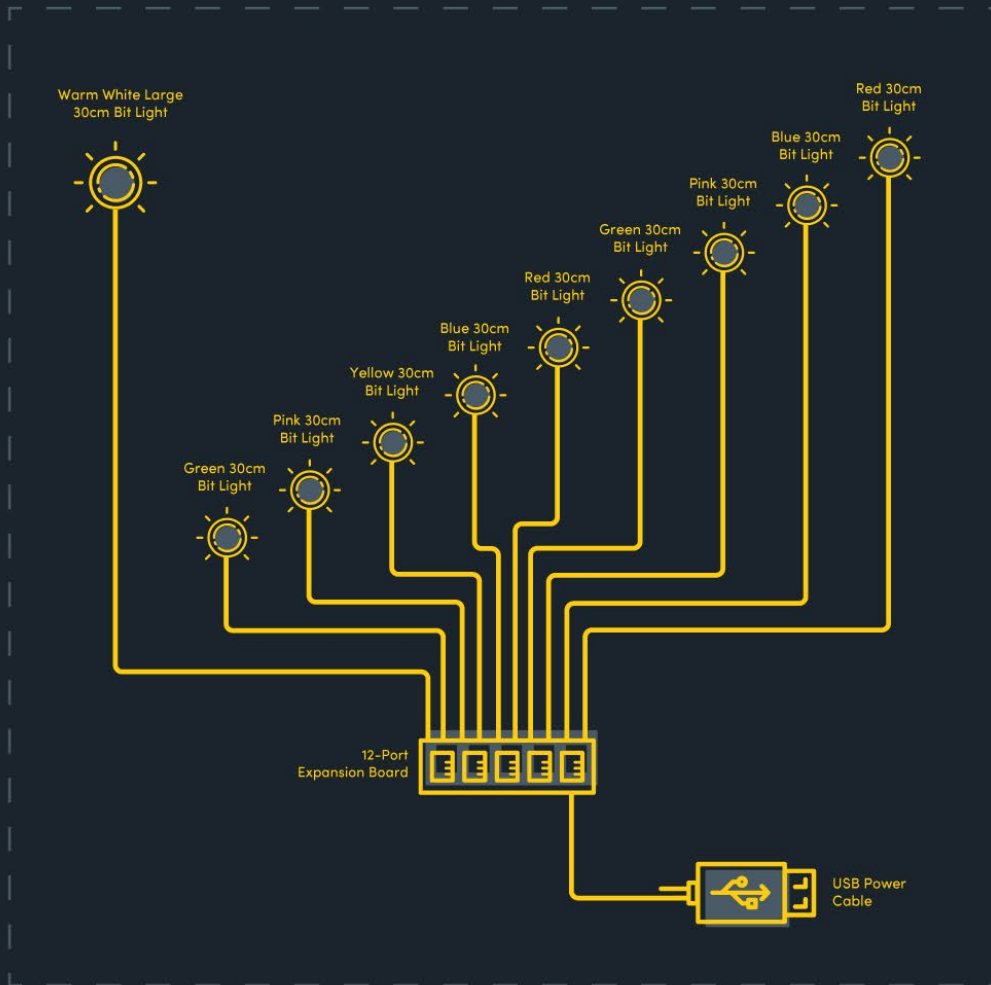

Small Candle Tree

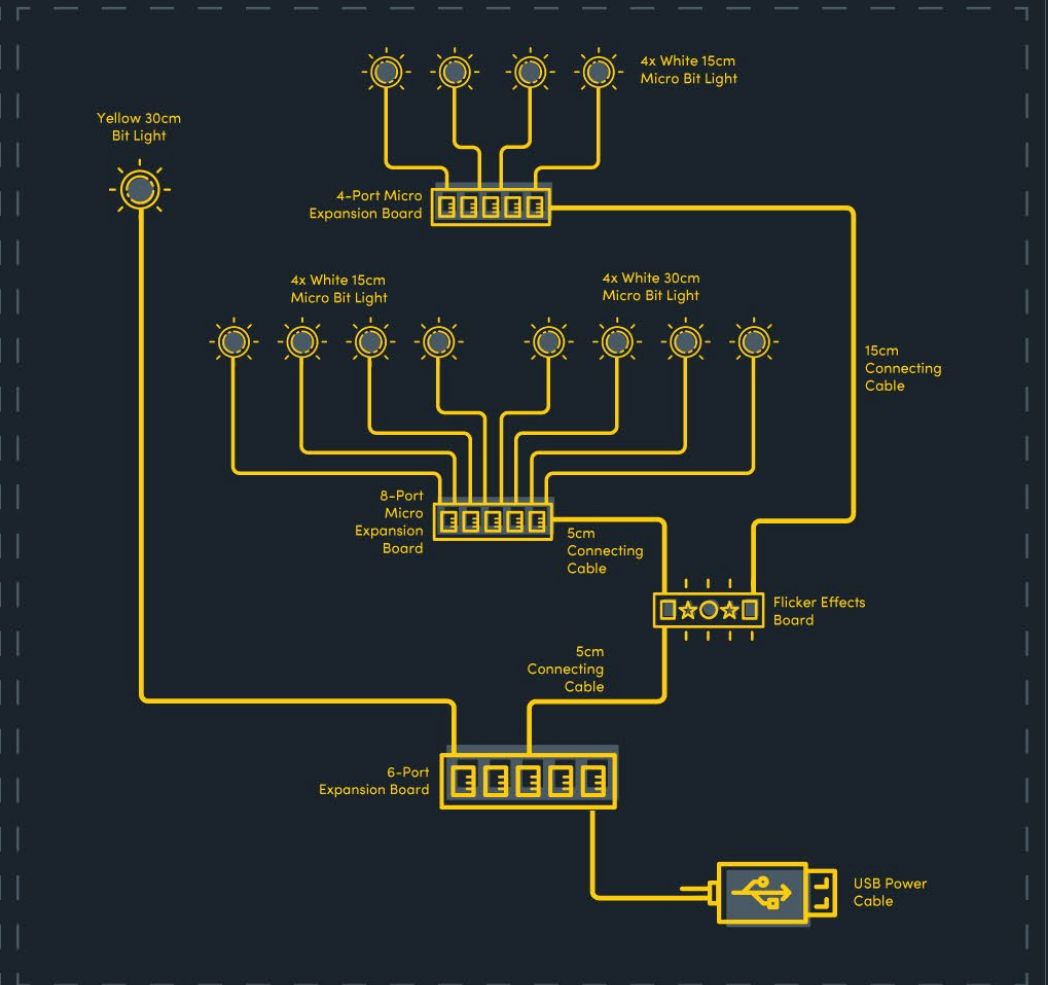



INSTRUCTIONS

The following section is for the “Large Tree” variant. To light up the “Medium and Small Tree”, skip to Page 51 or [click here](#).

To ensure a smooth installation of your light kit, please read and follow each step carefully. If you run into any issues, please refer to the online troubleshooting guide.



1



2

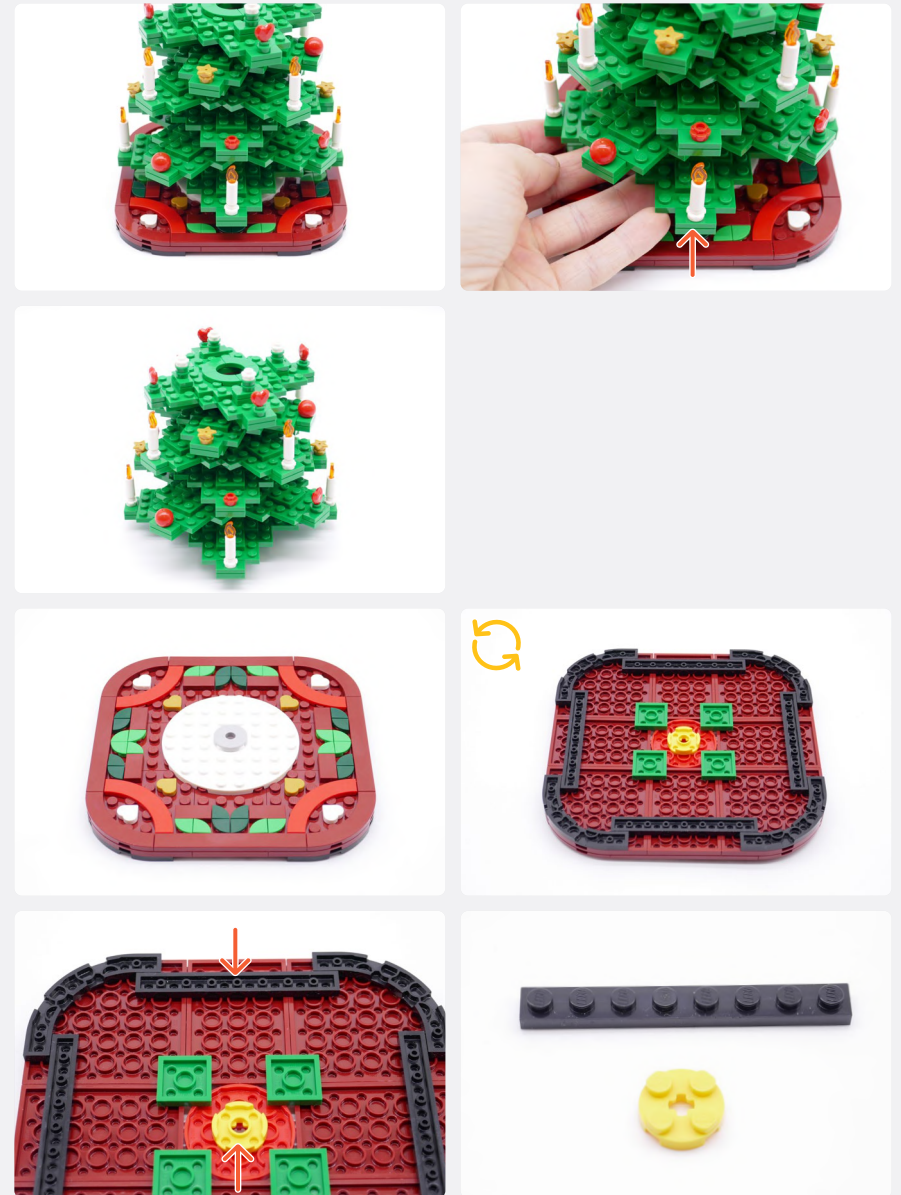

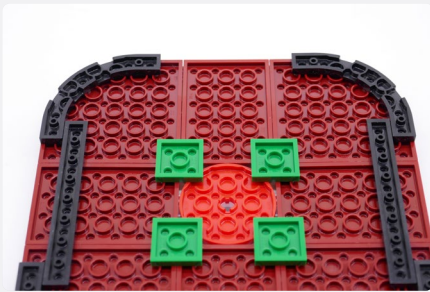

3

NOTE

Flip the base back over, holding the cable in place so it does not slip.

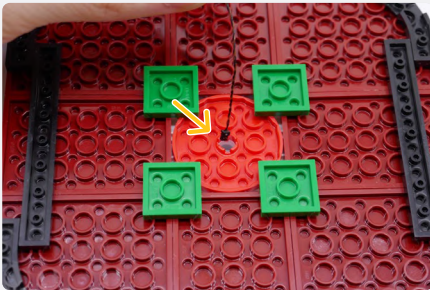

NOTE

Pull the USB Power Cable up and leave around 10cm of length.

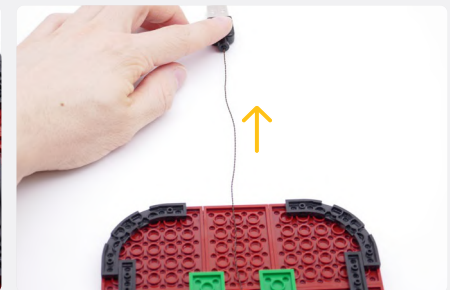
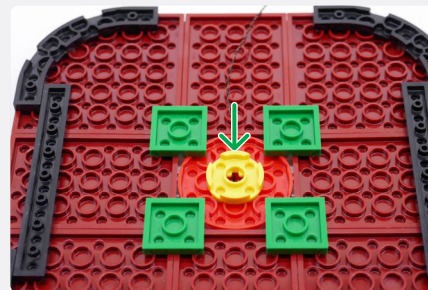
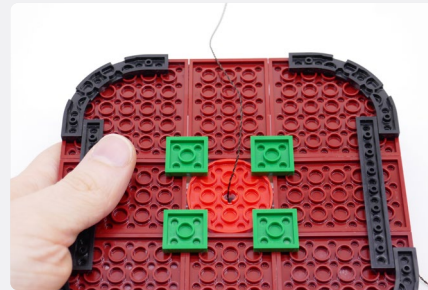

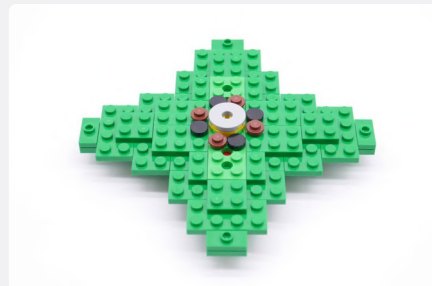
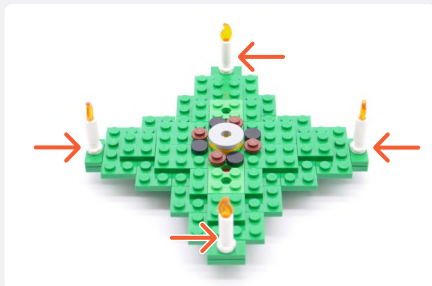
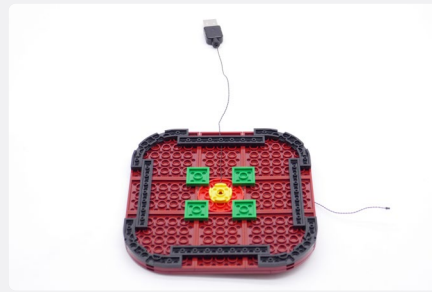
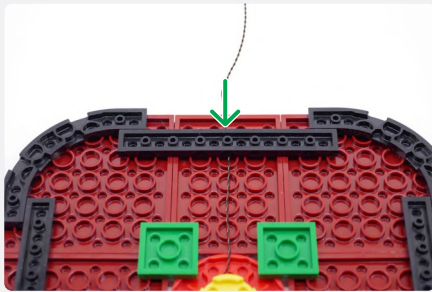

4

5

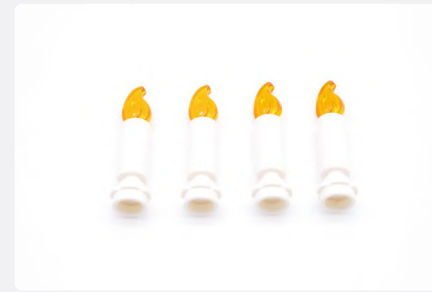

White 30cm Micro Bit Light



NOTE

Position the Micro Bit Light as shown, holding it in place when reconnecting the piece.

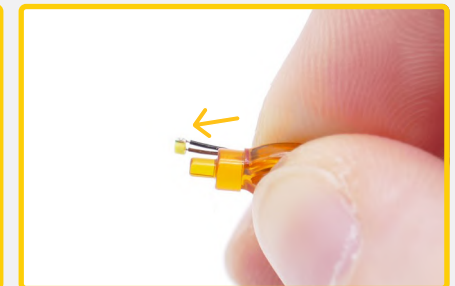

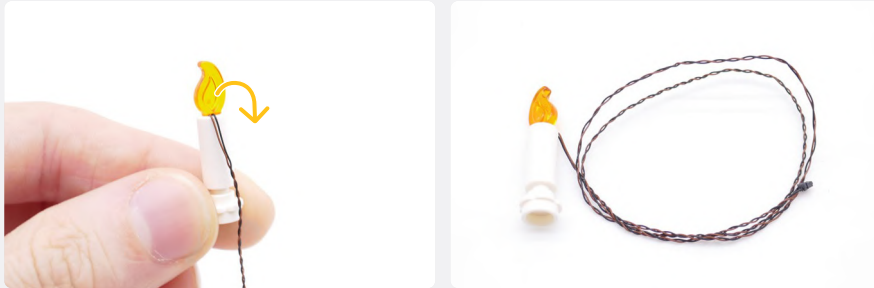
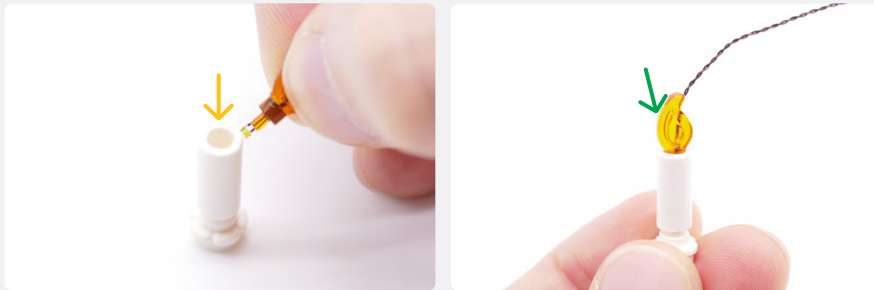

6

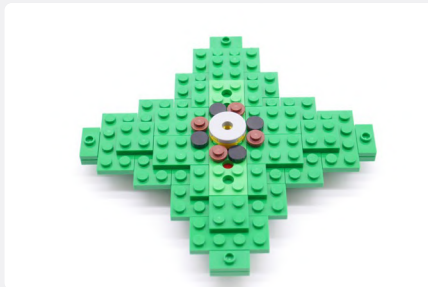

NOTE
Use the LEGO Brick Separator Tool to remove pieces like those shown.

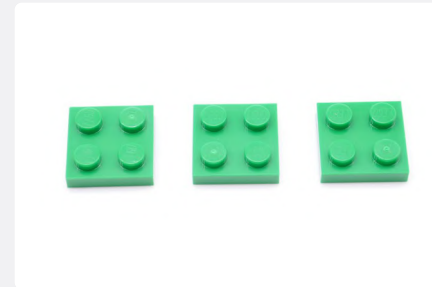
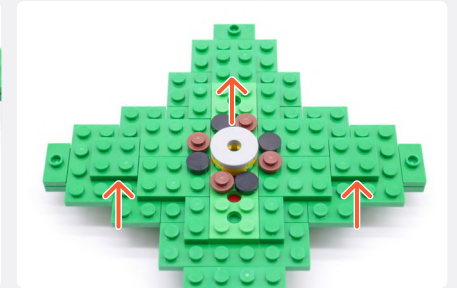
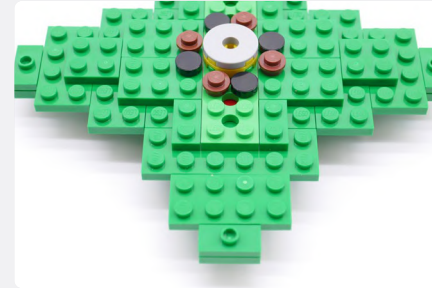

7

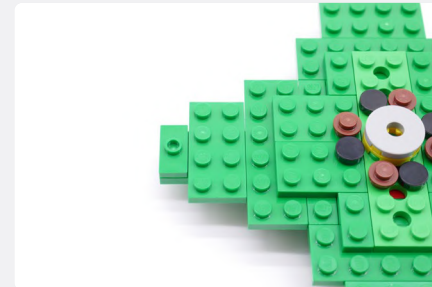

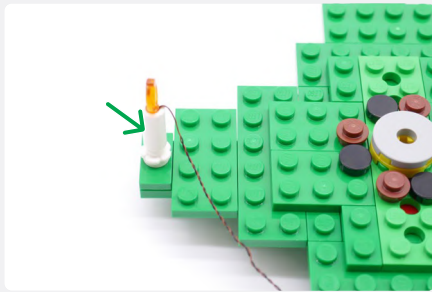

NOTE

Hold the cable against the Candle when connecting the green plate, to ensure the cable stays in place.

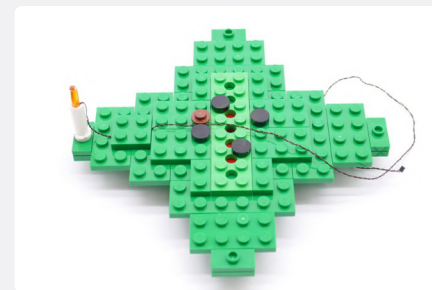
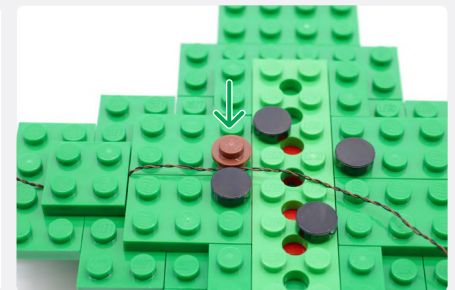
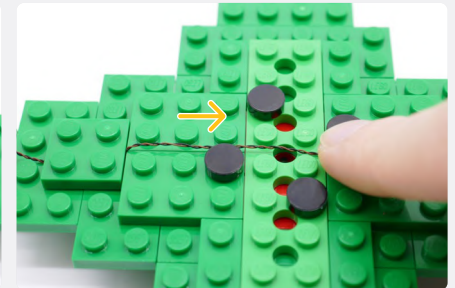
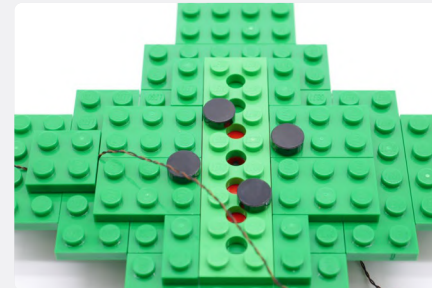
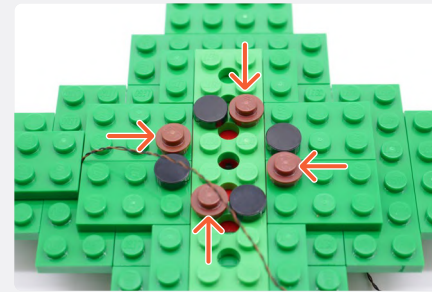
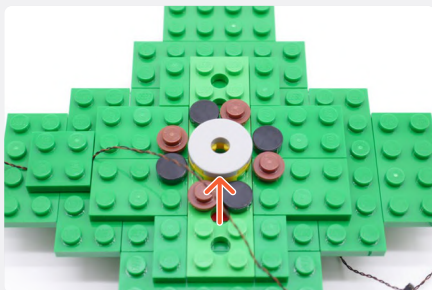
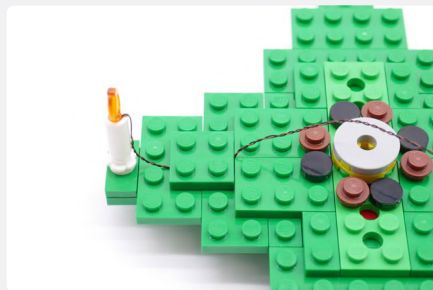
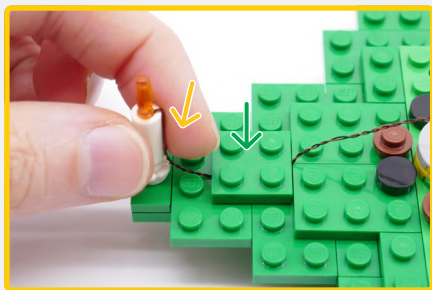

8

9

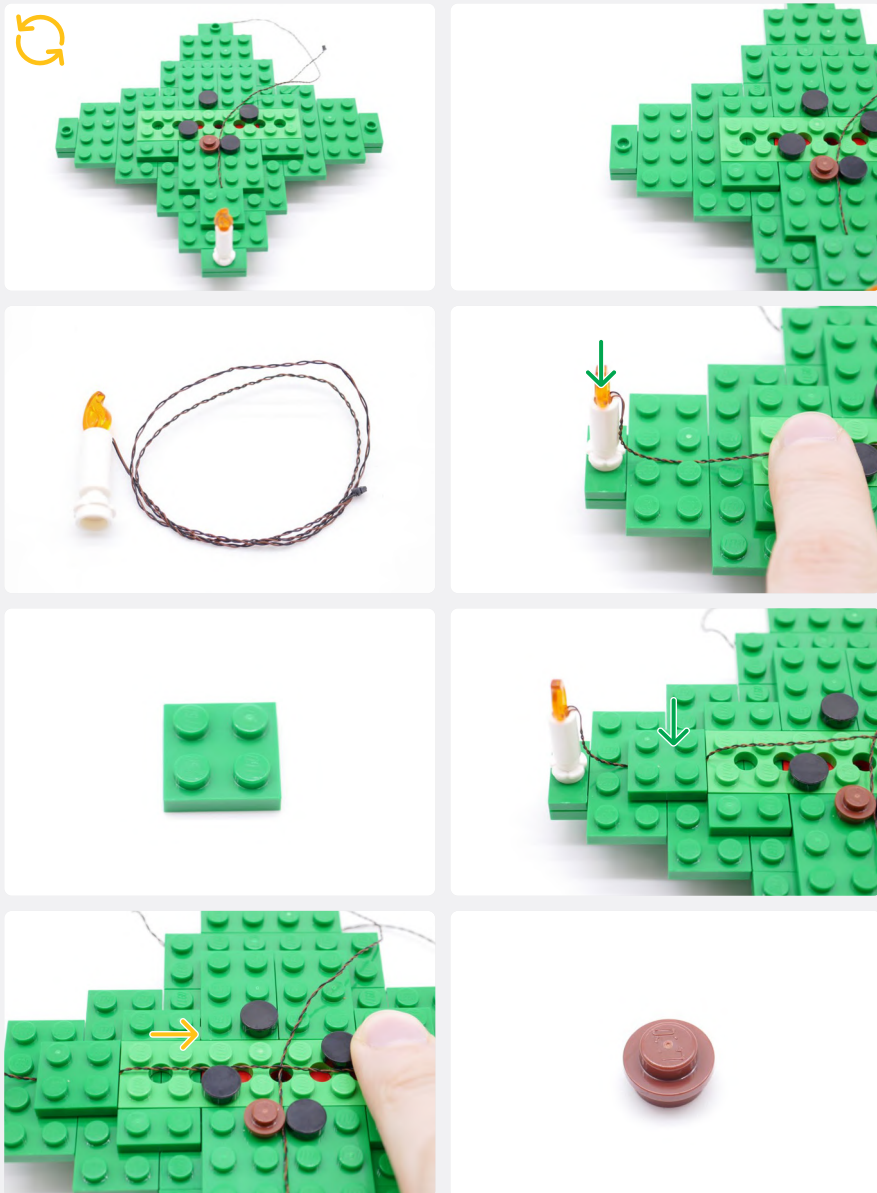

10

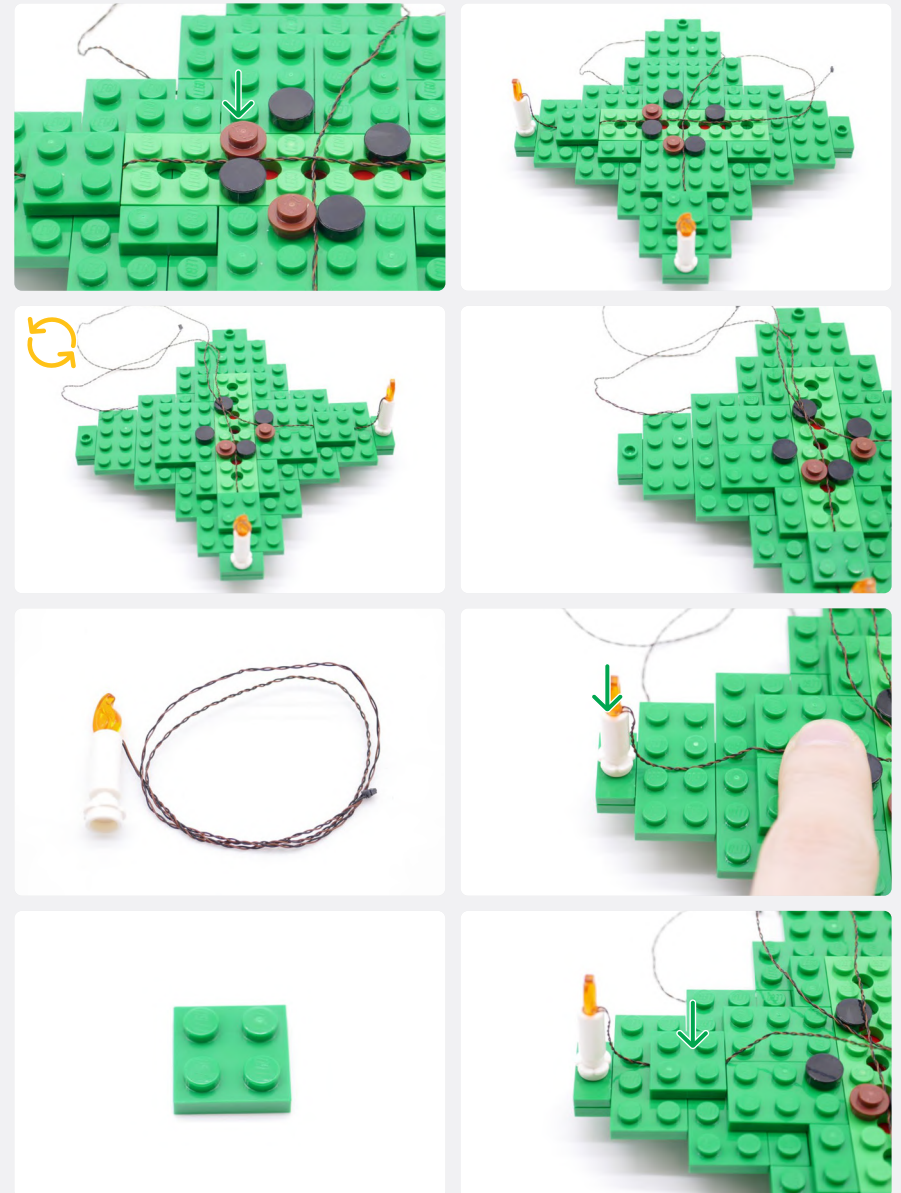

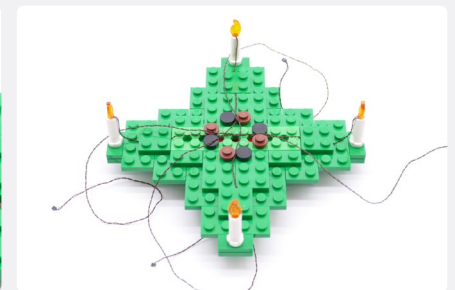
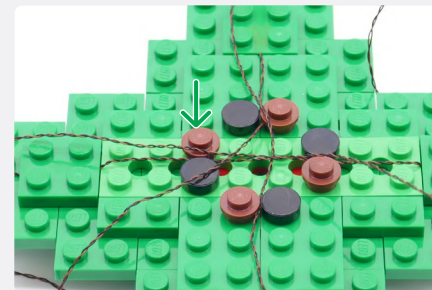
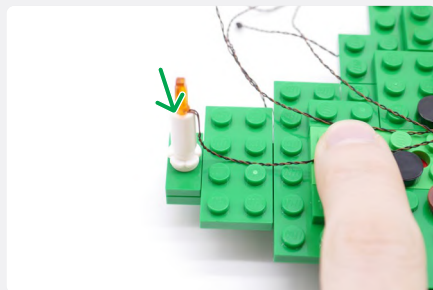
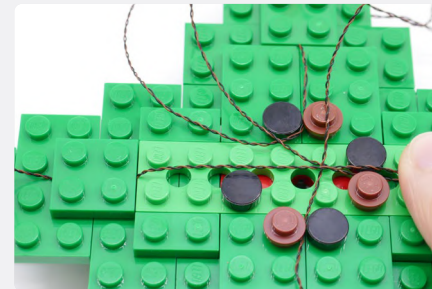
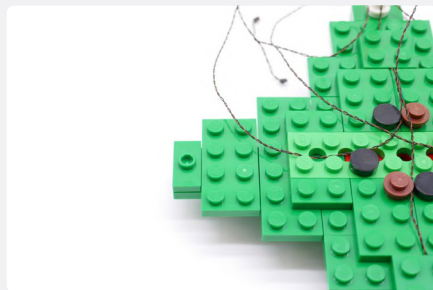
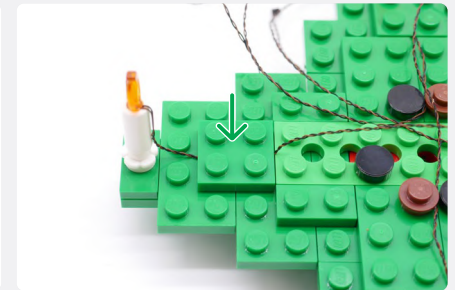
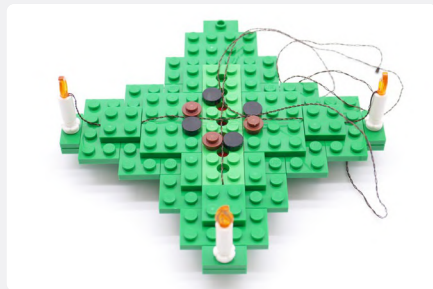
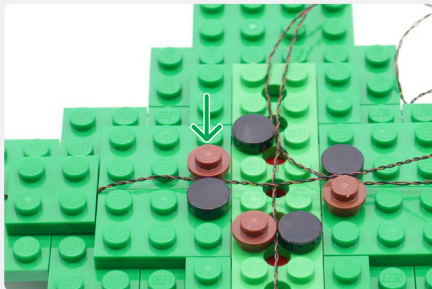
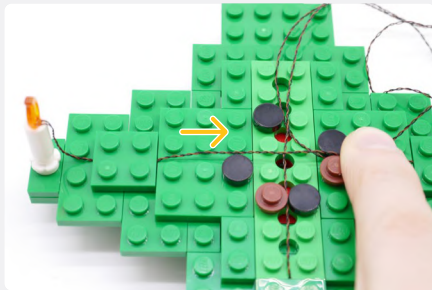

11

12

NOTE

Thread the USB Power Cable through the leaf section hole in the centre.

13

NOTE

For the next 6 of the coloured "lantern" lights, you can choose to use any colour in any order. Follow the guide normally for the default look.

Brick Round 1x1 - Trans Clear

Pink 30cm Bit Light

14
Brick Round 1x1 - Trans Clear

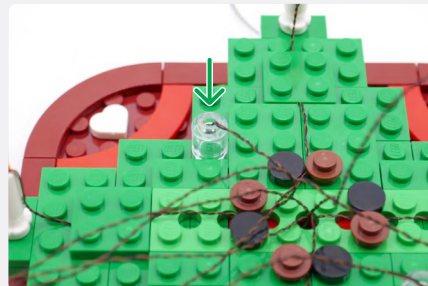
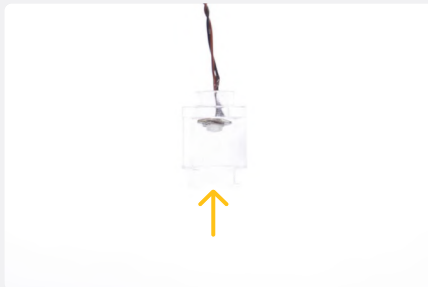
Green 30cm Bit Light

15

NOTE

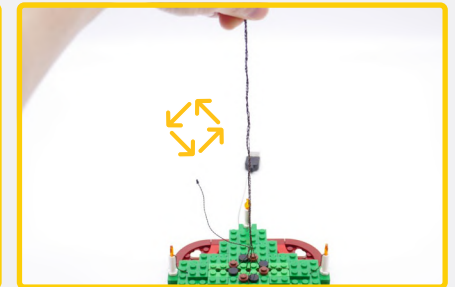
Take the 4 Micro Bit Light Cables and twist together, by holding them up as shown and twirling lightly.

NOTE

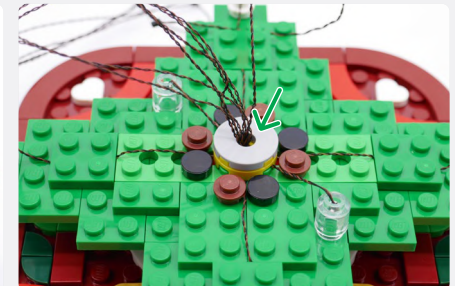
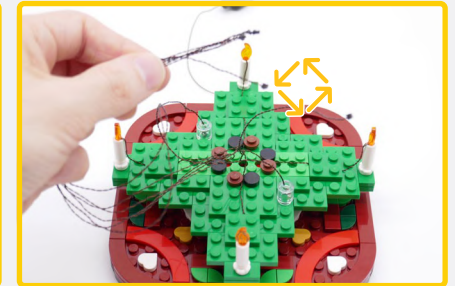
Take all of the cables and bunch them together by lightly twisting, and thread them through the circular piece.



16

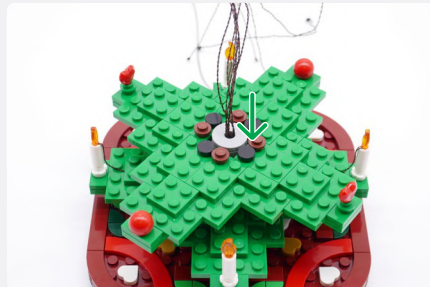

NOTE

Take the 4 Micro Bit Light Cables and twist together, by holding them up as shown and twirling lightly.



17



Brick Round 1x1 - Trans Clear



Yellow 30cm Bit Light



18

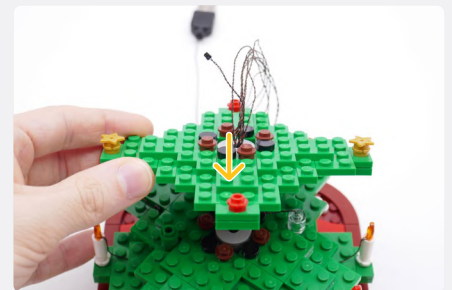
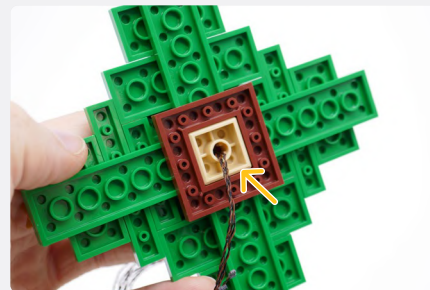
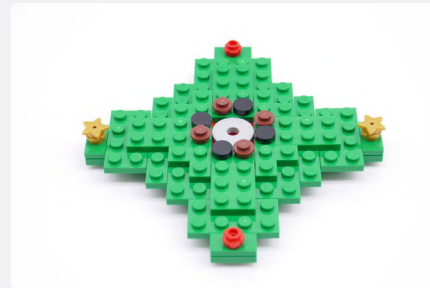
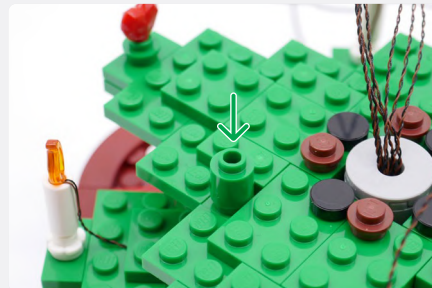

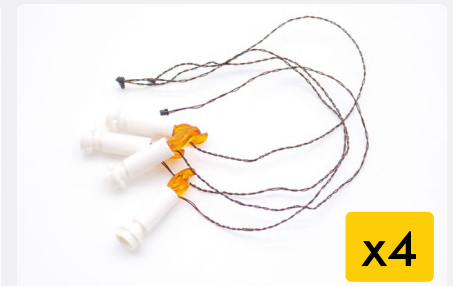
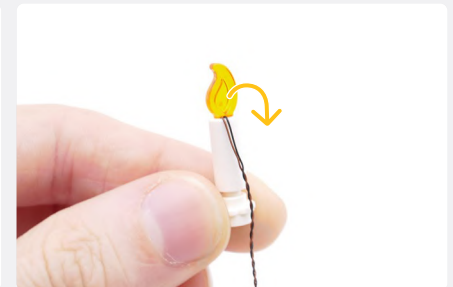
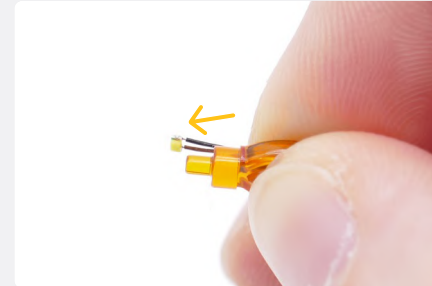
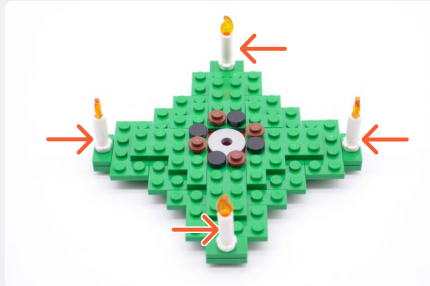

19

20

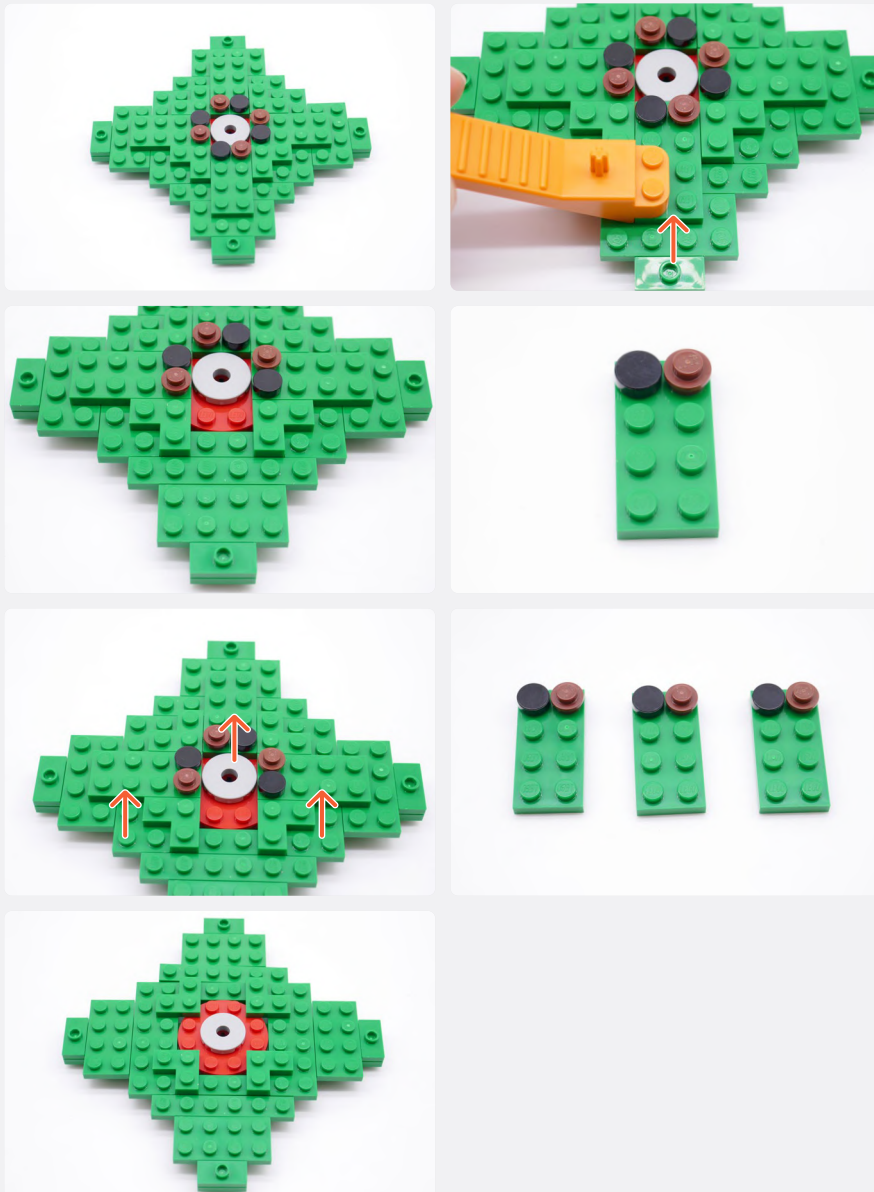

21

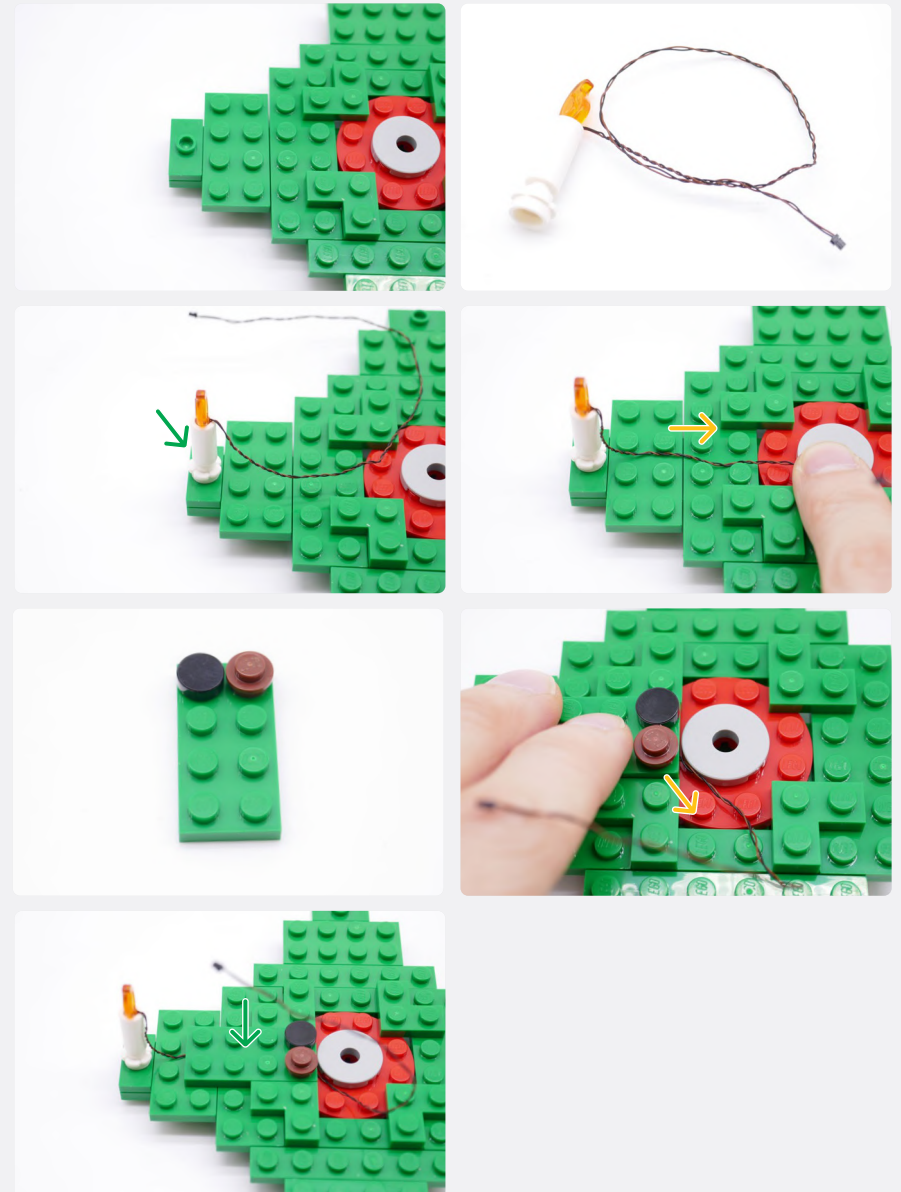

22

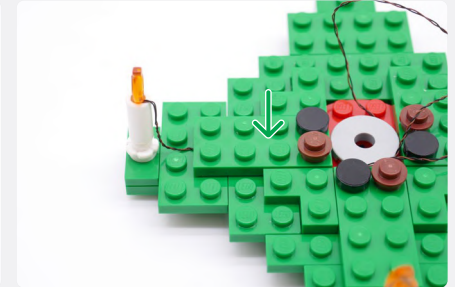
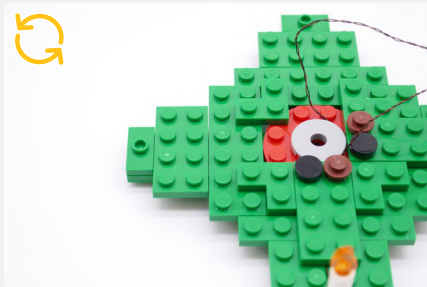
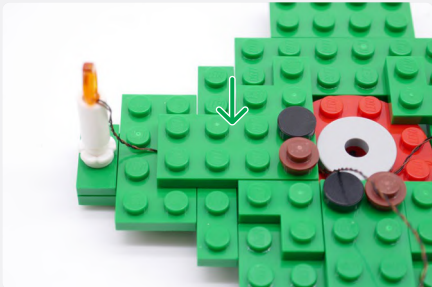
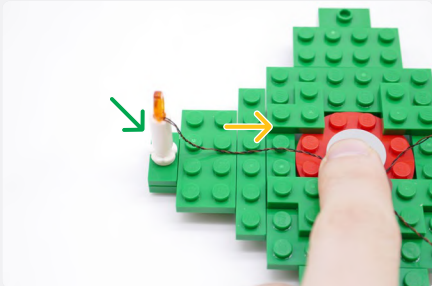

23

Brick Round 1x1 - Trans Clear



Blue 30cm Bit Light

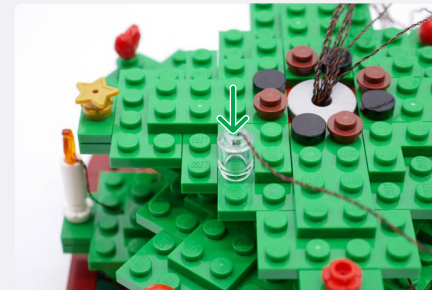

Brick Round 1x1 - Green

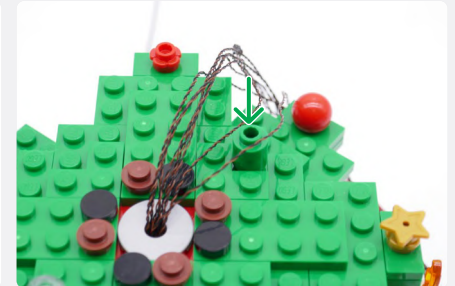

24

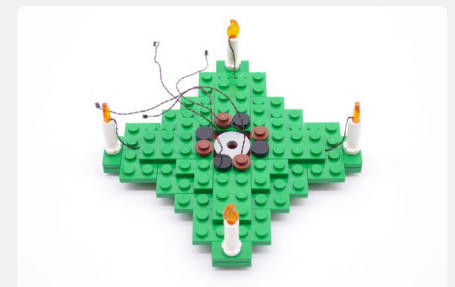

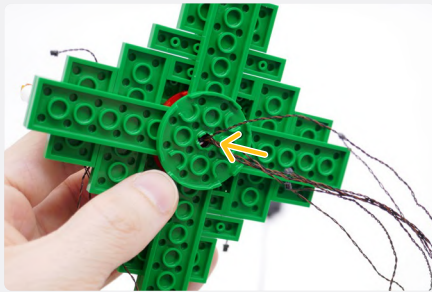

25

NOTE

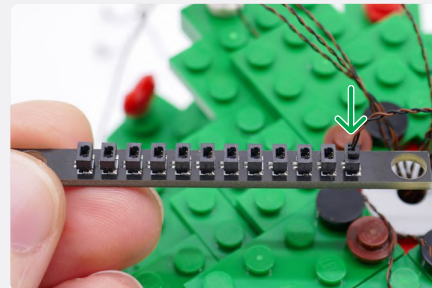
Take the USB Power Cable (shortest cable) and connect it to a 12-Port Expansion Board.

12-Port Expansion Board

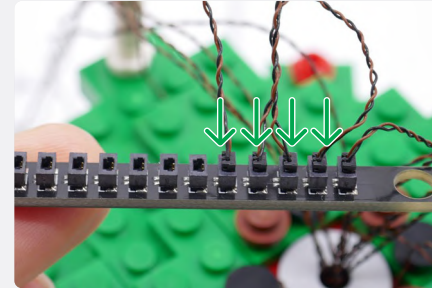
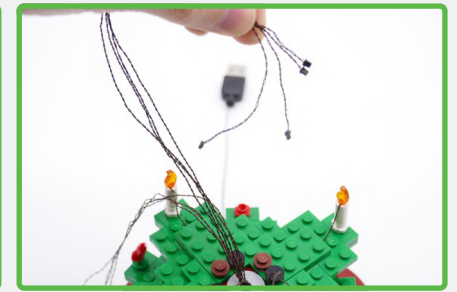
NOTE

Take the 4 cables from the Bit Lights and connect them to the 12-Port Expansion Board.

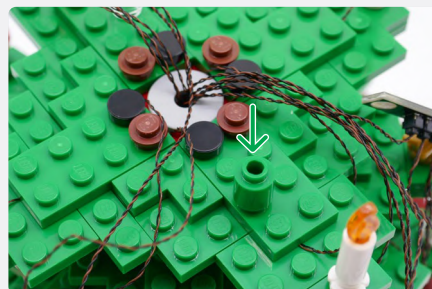
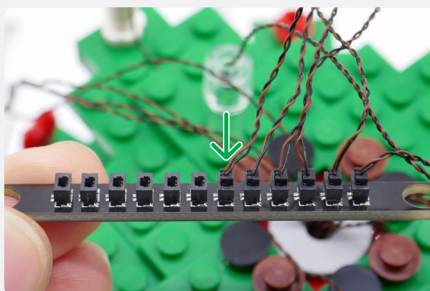

26
Brick Round 1x1 - Trans Clear

Red 30cm Bit Light





27



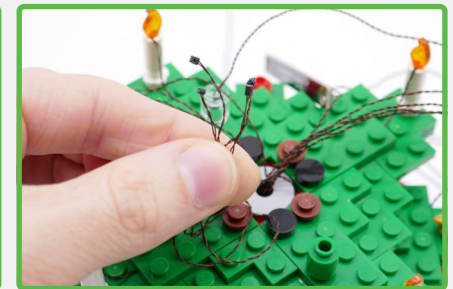

 **NOTE**

Take the 4 Micro Bit Light 15cm Cables from that level and connect them to an 8-Port Micro Expansion Board.

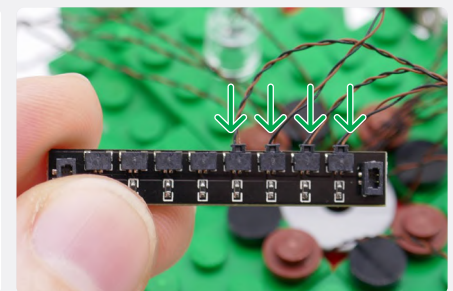

8-Port Micro Expansion Board



 **NOTE**

Twist those cables by holding the board up as shown and lightly twirling it until it appears like in the following image.

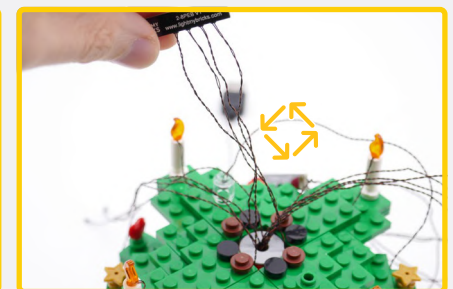

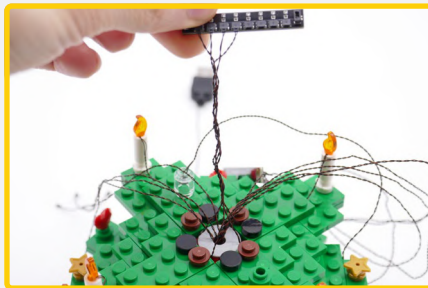

NOTE

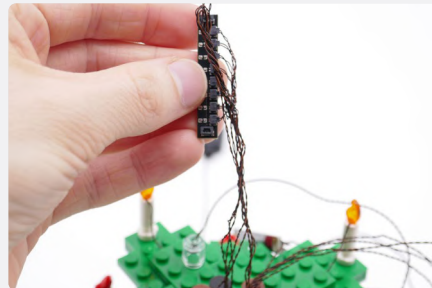
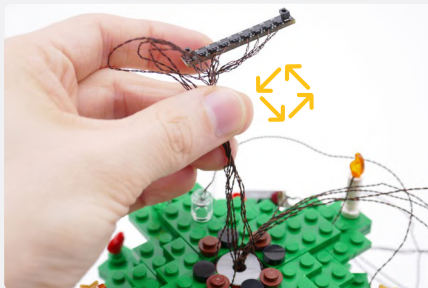
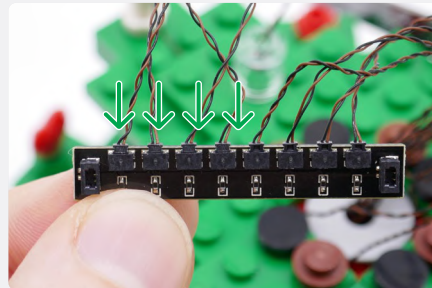
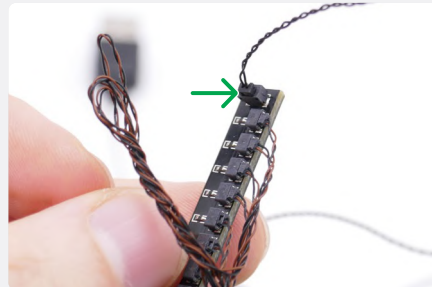
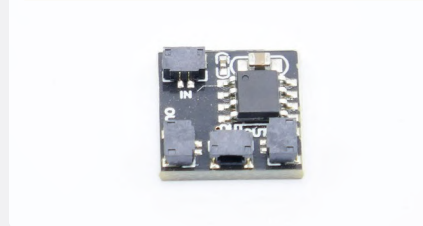
Take the 4 Micro Bit Light 30cm Cables from the hole and connect them to the 8-Port Micro Expansion Board.

5cm Connecting Cable

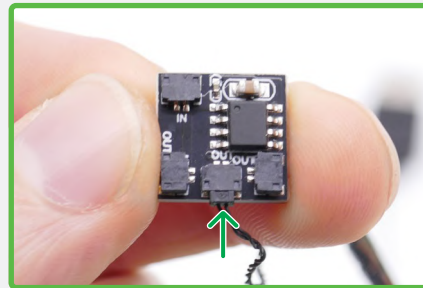
28
Flicker Effects Board

NOTE

Connect the 5cm Connecting Cable from the 8-Port Micro Expansion Board into the "OUT" port of the Flicker Effects Board

5cm Connecting Cable

NOTE

Connect a new 5cm Connecting Cable into the "IN" port of the Flicker Effects Board



29
NOTE

Take the 12-Port Expansion Board and twist all of the cables from it together.



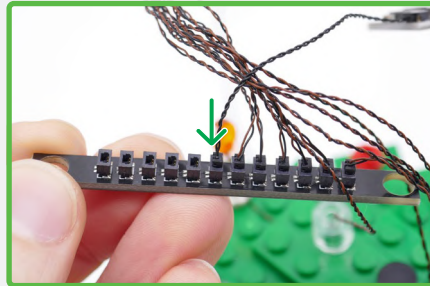
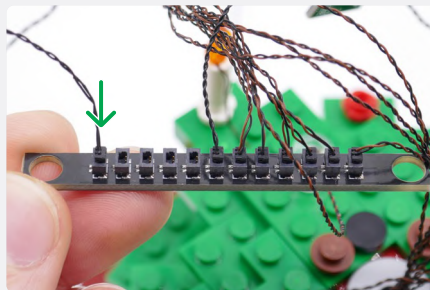

NOTE

Connect the 5cm Connecting Cable from the "IN" port of the Flicker Effects Board, to the 12-Port Expansion Board.

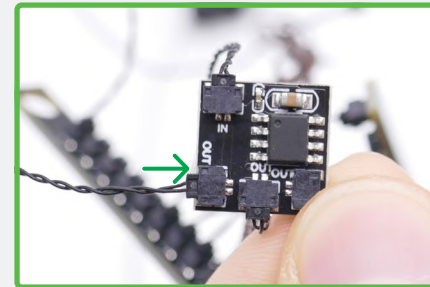
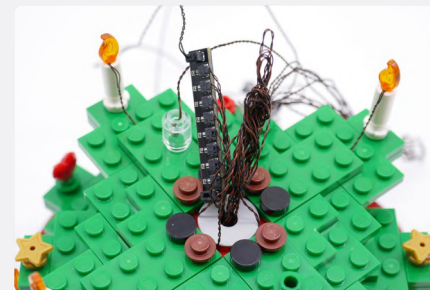
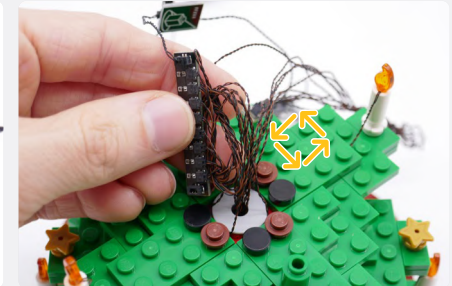
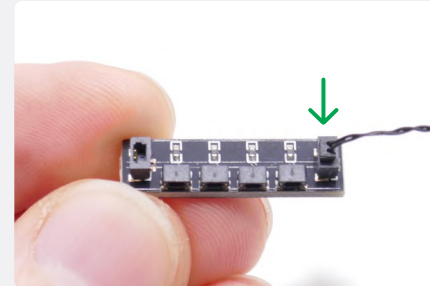

15cm Connecting Cable

15cm Connecting Cable

NOTE

Connect a new 15cm Connecting Cable into the "OUT" port of the Flicker Effects Board.

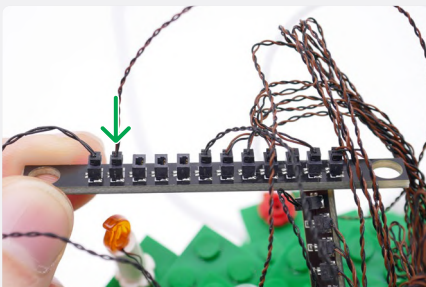
4-Port Micro Expansion Board

31
Brick Round 1x1 - Trans Clear

Green 30cm Bit Light

NOTE

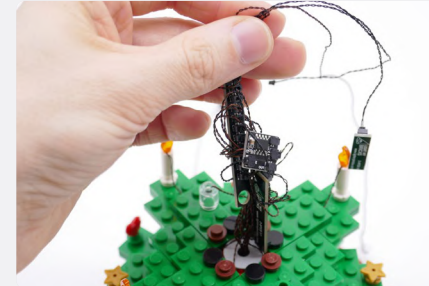
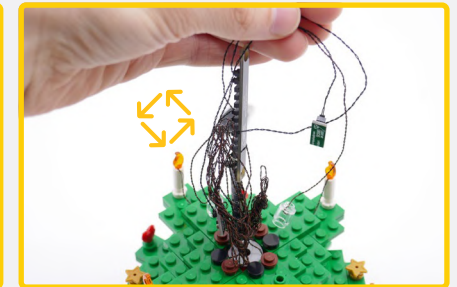
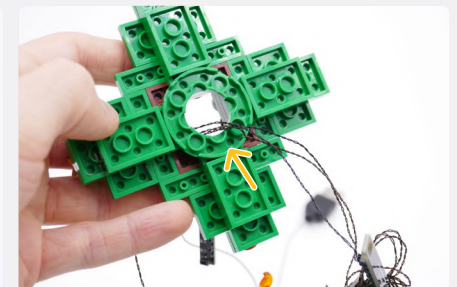
Leave the 15cm Connecting Cable, 4-Port Micro Expansion Board, and the Green Lantern out from twisting.

32

NOTE

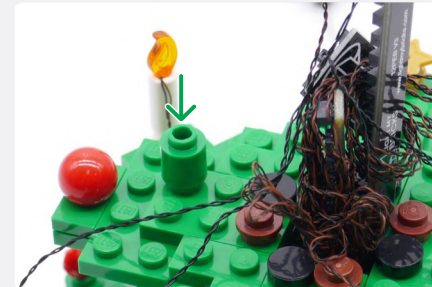
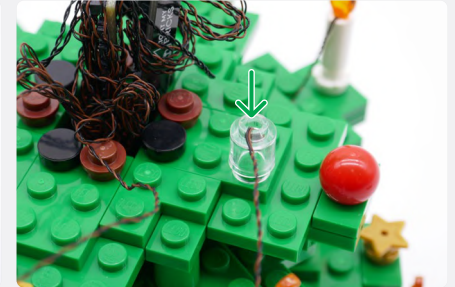
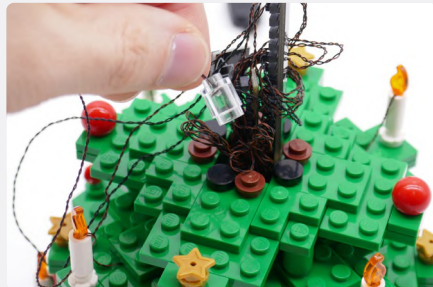
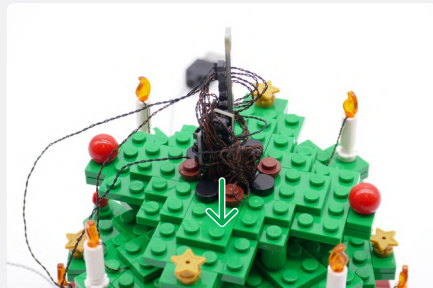
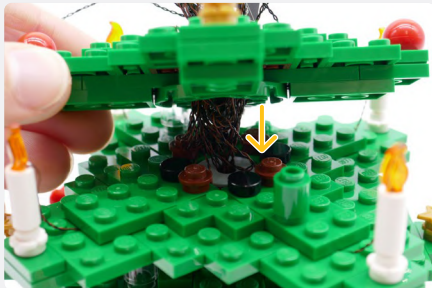
Take care when threading through all of the Boards and Cables. Do not force it. If they don't go through at first, bundle them and try again.



33

34

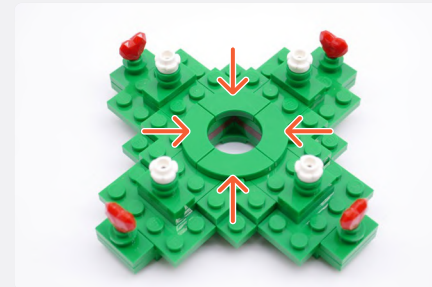



35

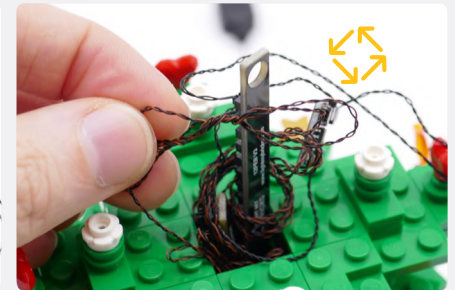
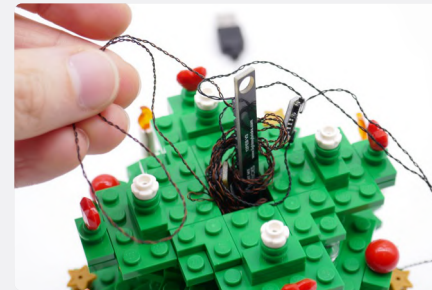

NOTE

Ensure all of the cables are threaded up through the hole to the next level, and not squished between the studs.

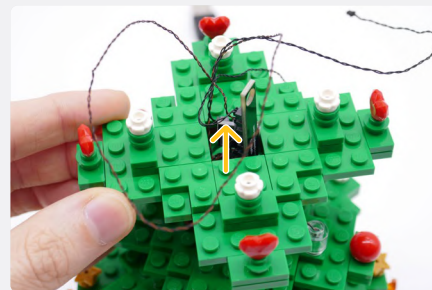
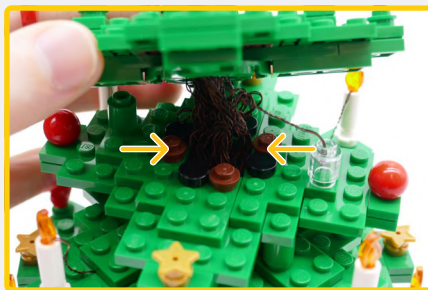
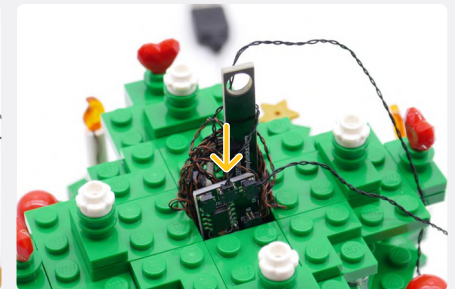
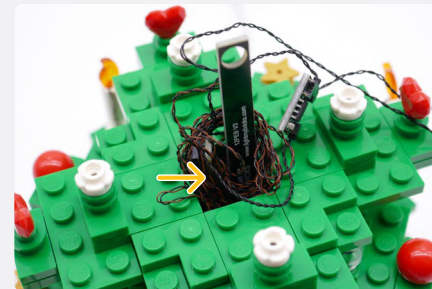

6-Port Expansion Board

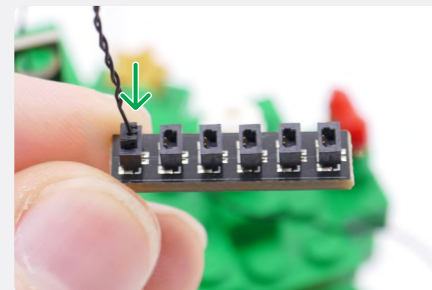

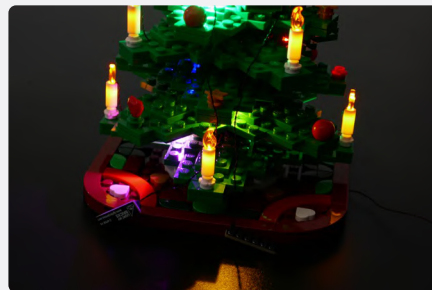

NOTE

Connect to a 5V USB Power Bank, 5V USB Wall Adaptor, or USB to AA Battery Pack (sold separately)

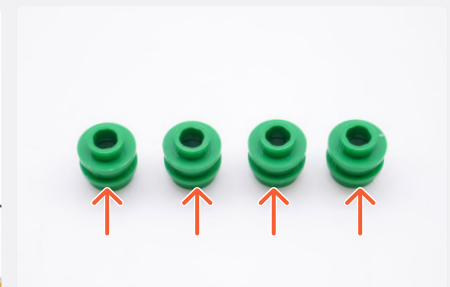
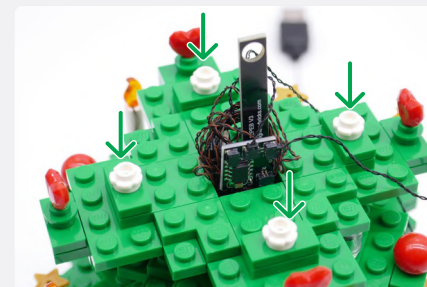
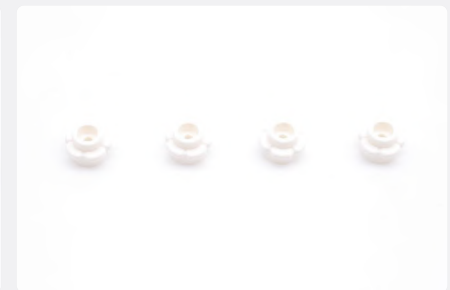
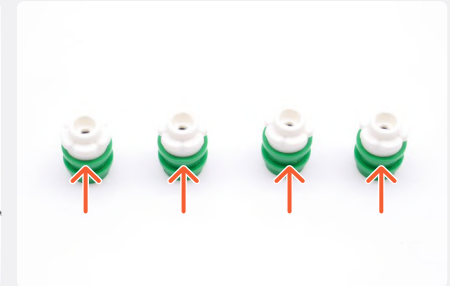
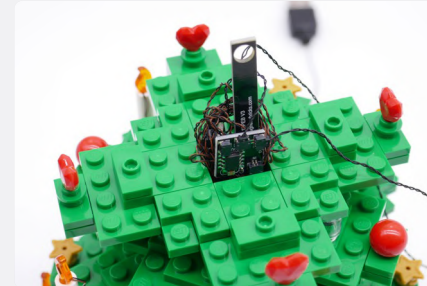
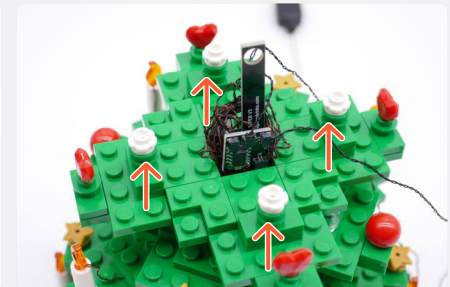

! If you experience any issues with the lights not working and suspect an issue with a component, please try a different port on the expansion board to verify where the fault lies (with the light or expansion board). To correct any issues with expansion board ports, please view the section addressing expansion board issues in our troubleshooting section. i

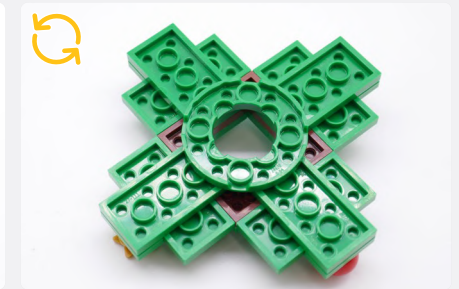
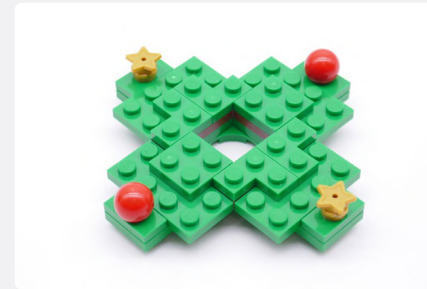
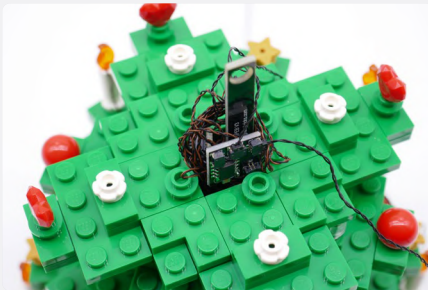
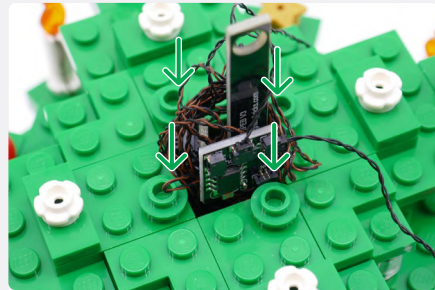
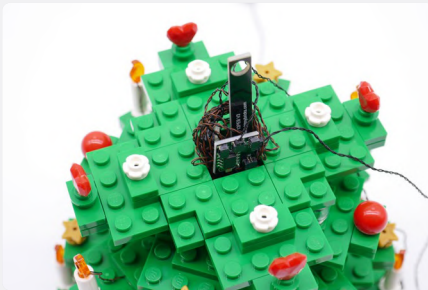
36



Brick Round 1x1 - Trans Clear

Pink 30cm Bit Light

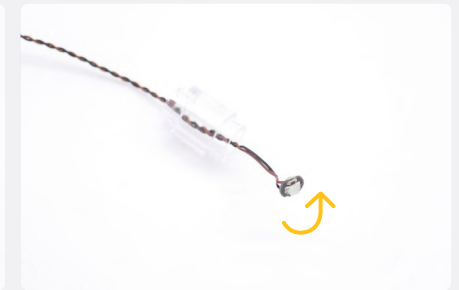

37

38

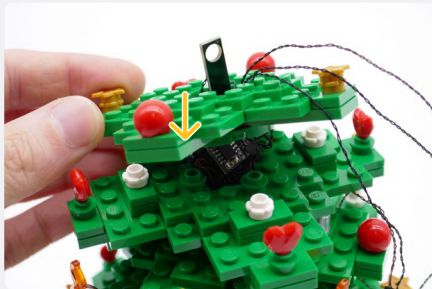
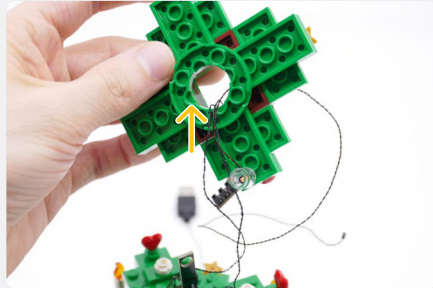
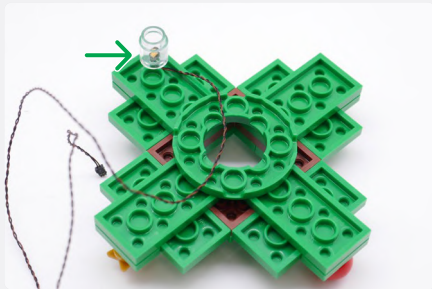

39

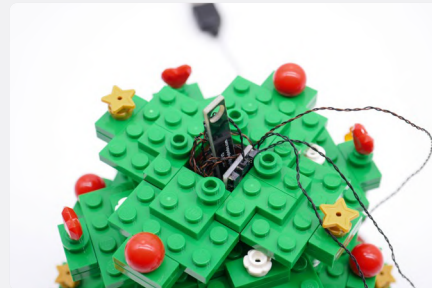
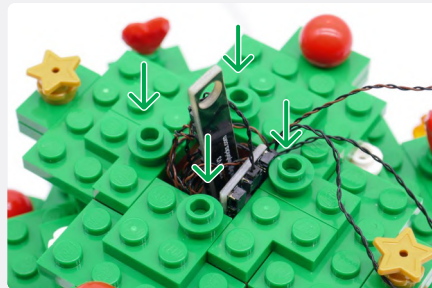
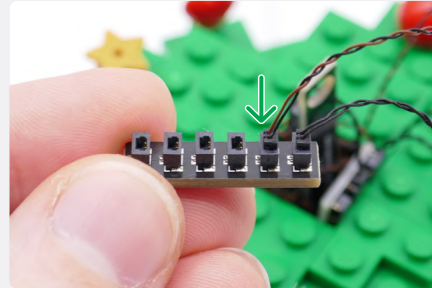

40

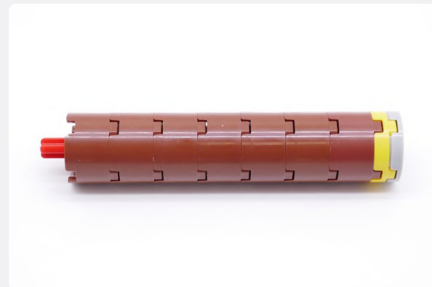

41

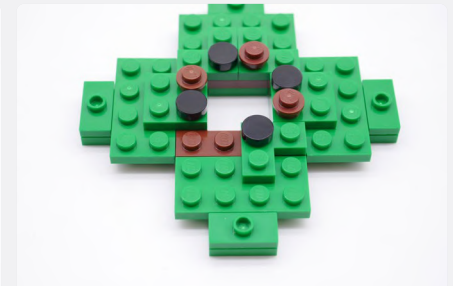
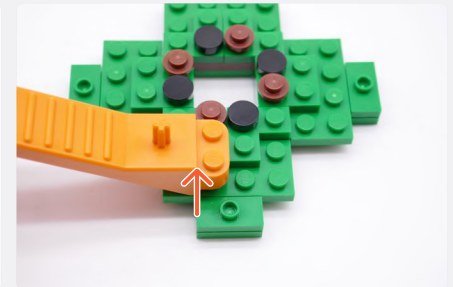
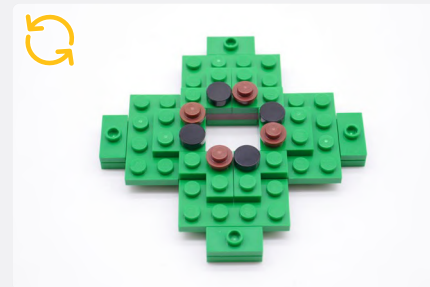
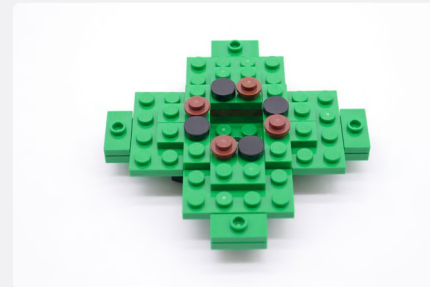

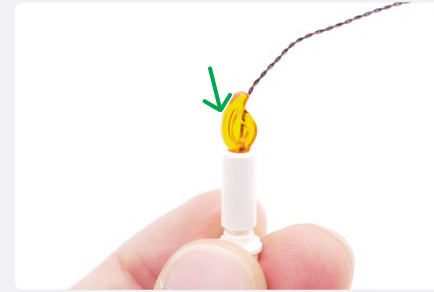
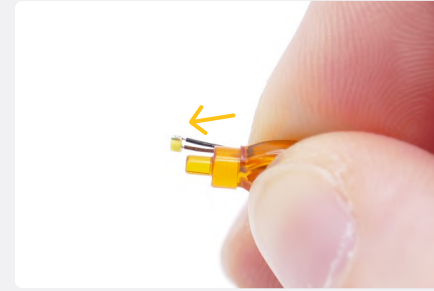
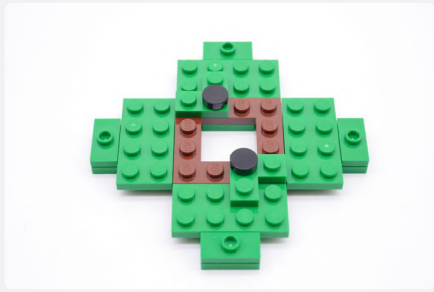
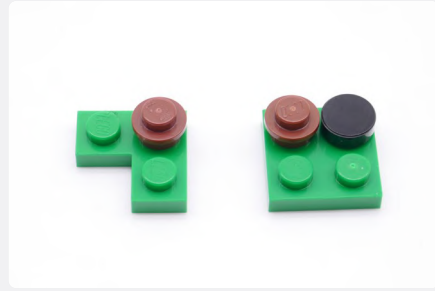
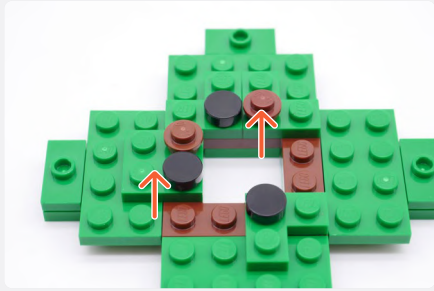
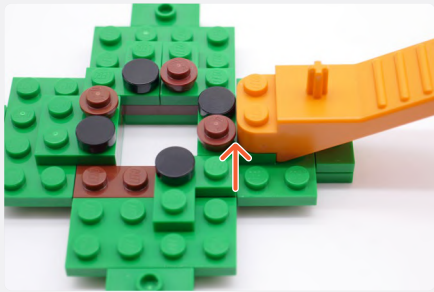

42

43

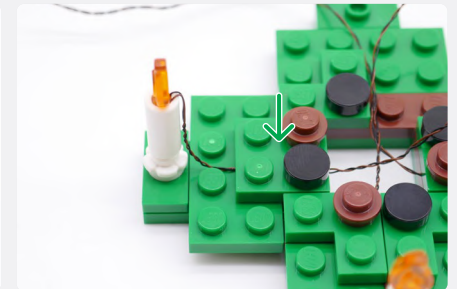
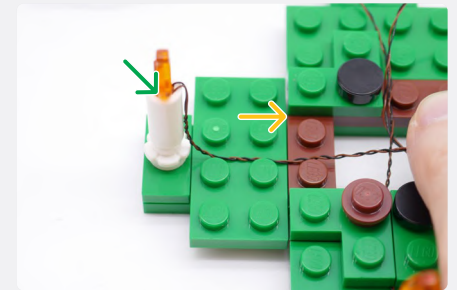
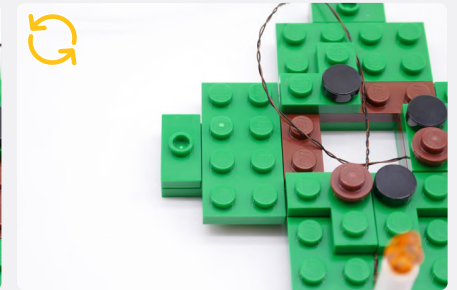
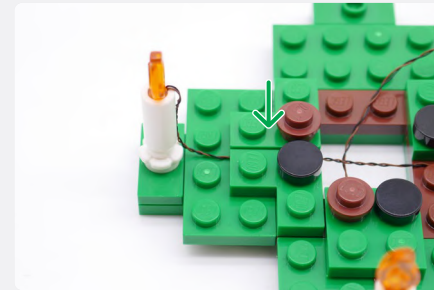
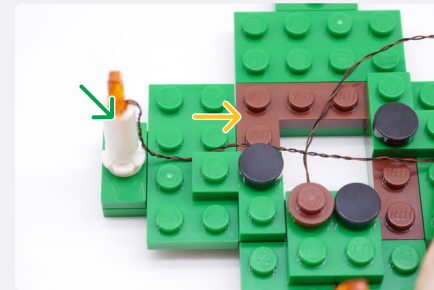
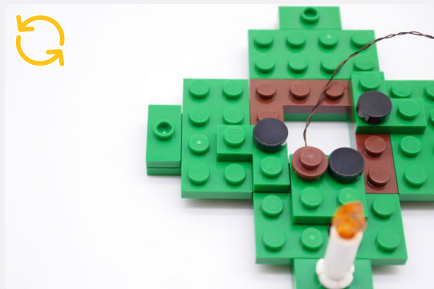
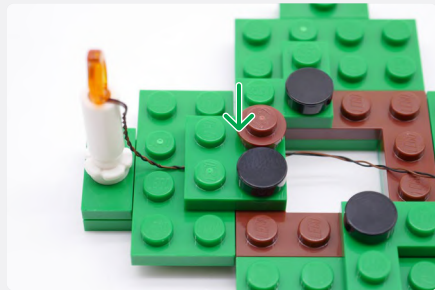
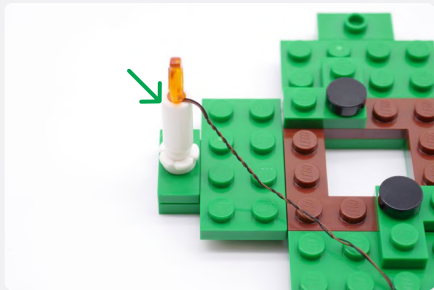
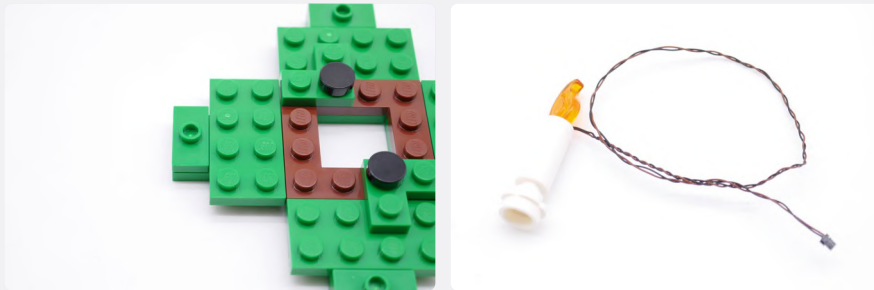

44

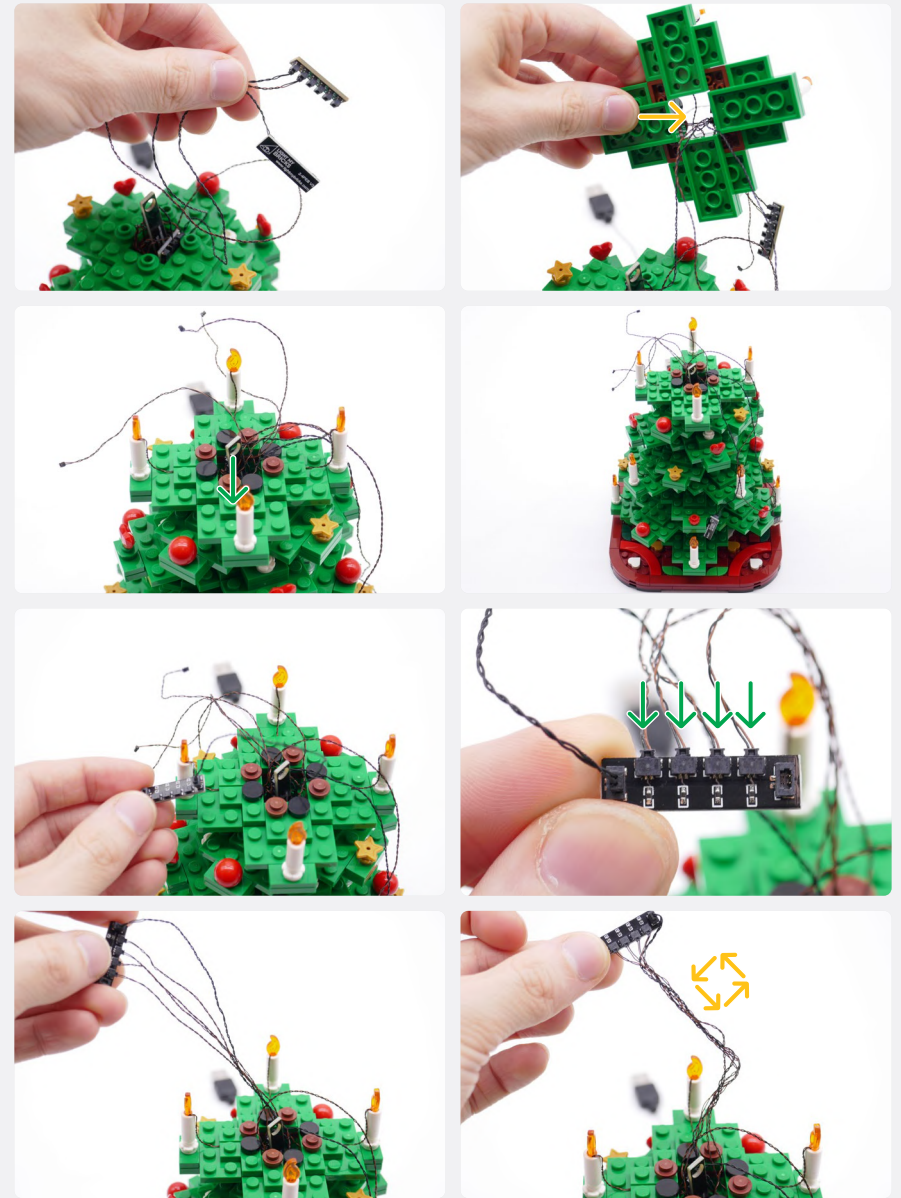
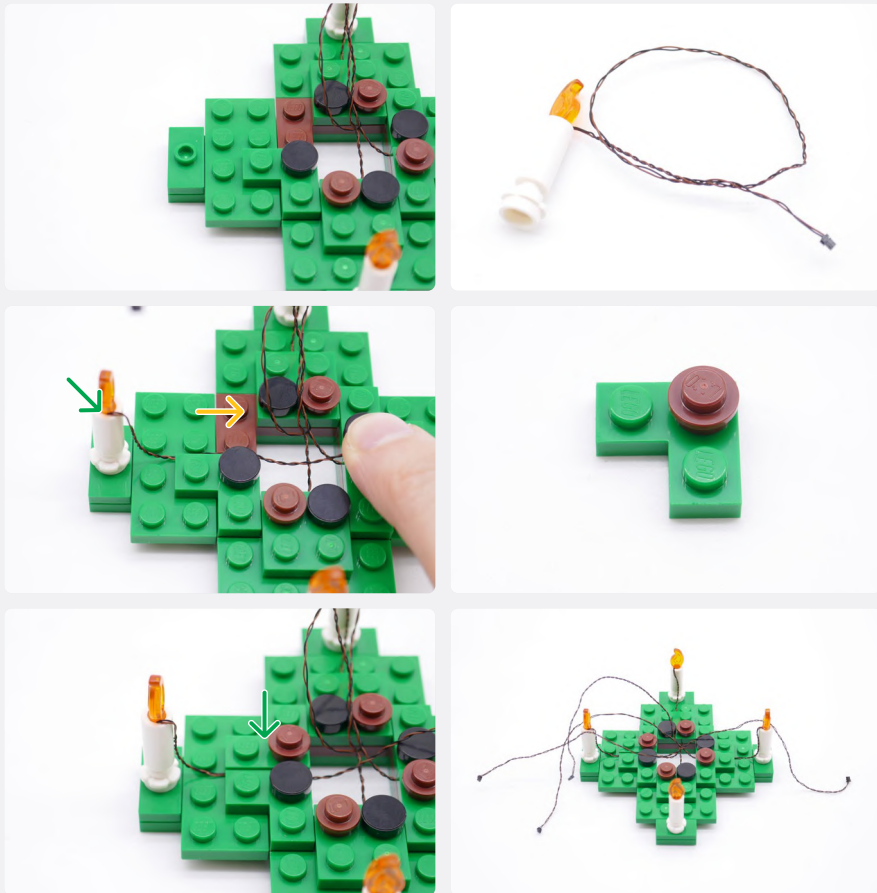

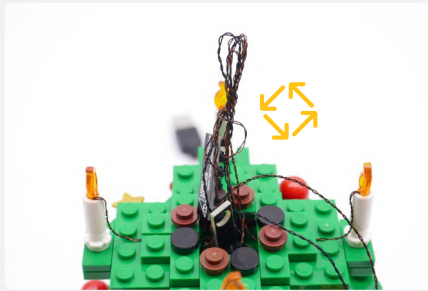

NOTE

Push the bundle of wires into the hole to appear like shown. Do not force it if stuck, move around the boards and try again.

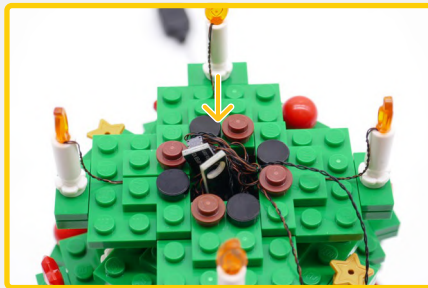

Brick Round 1x1 - Trans Clear

Yellow 30cm Bit Light

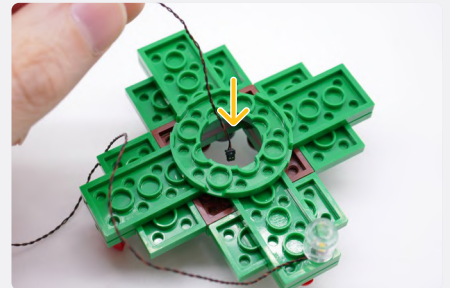
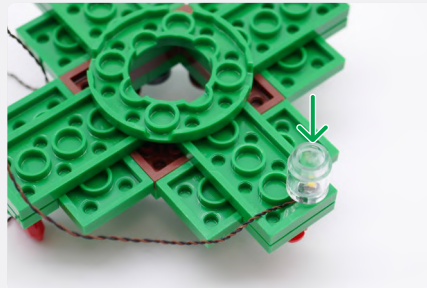
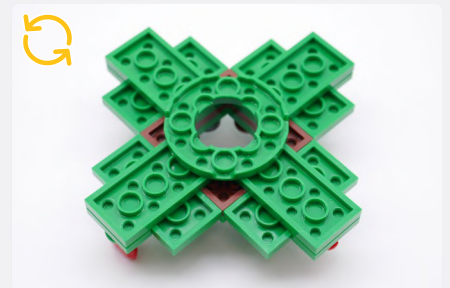

45

46

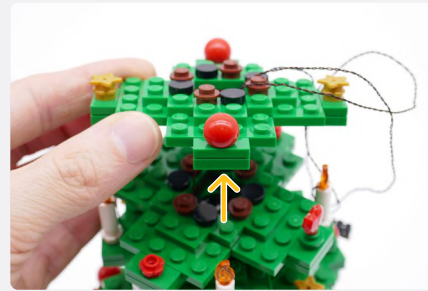
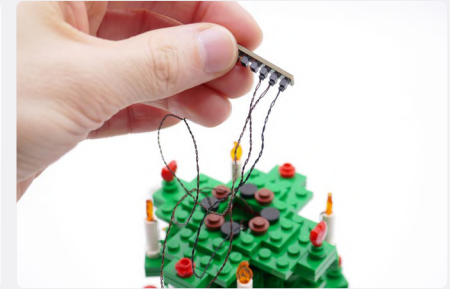
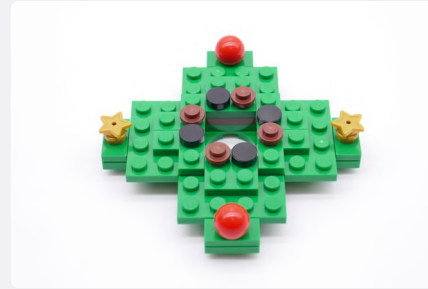
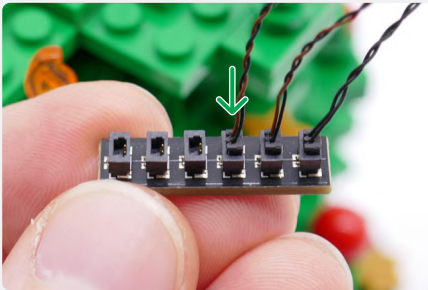
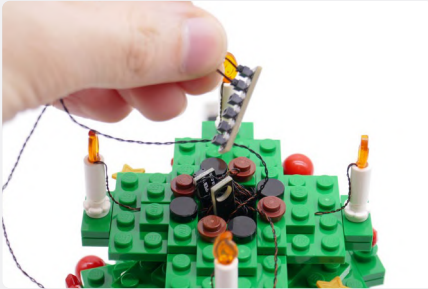

47



Brick Round 1x1 - Trans Clear



Blue 30cm Bit Light

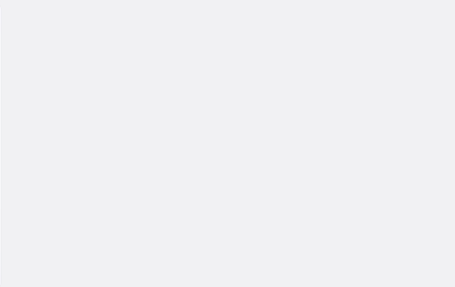
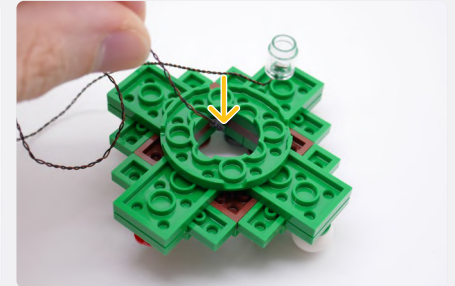
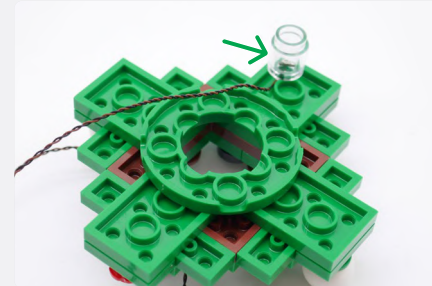

48

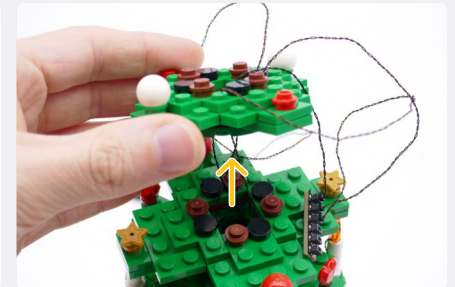

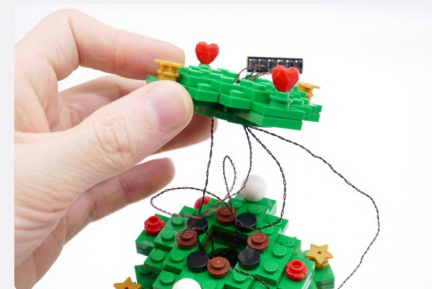
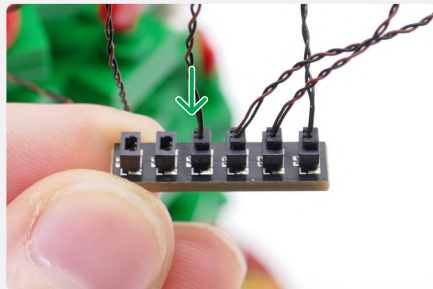

50

Brick Round 1x1 - Trans Clear



Red 30cm Bit Light



49

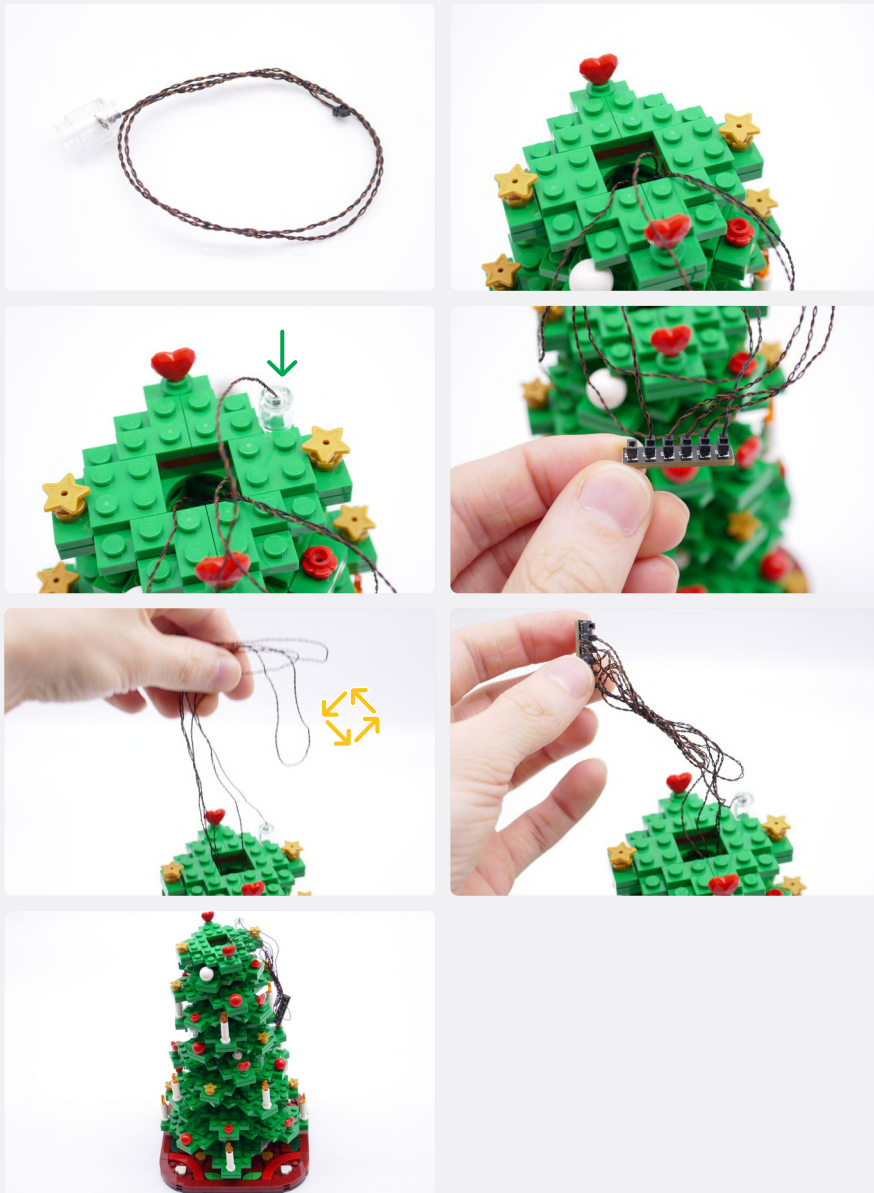

51

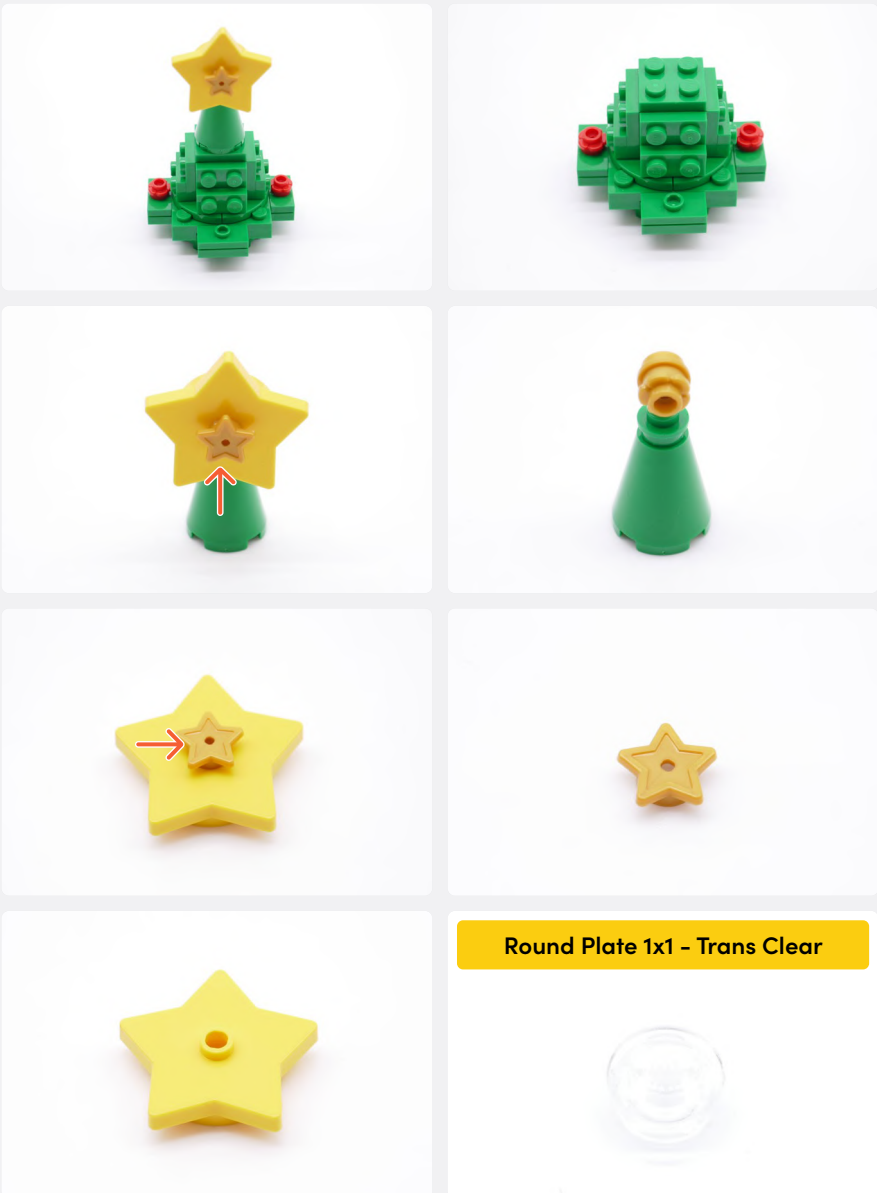

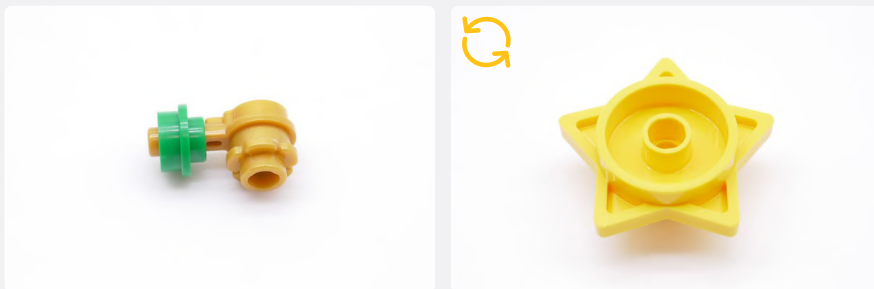
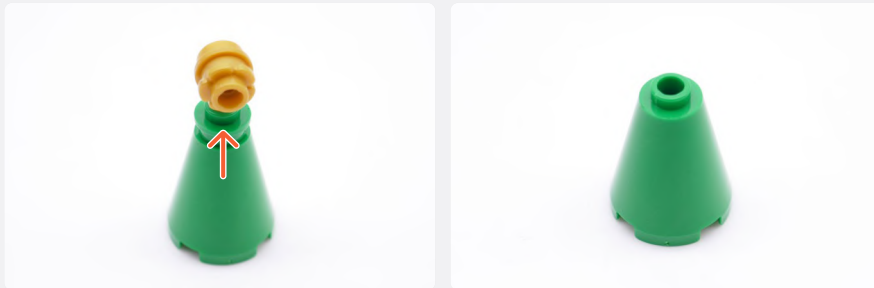

Warm White 30cm Large Bit Light

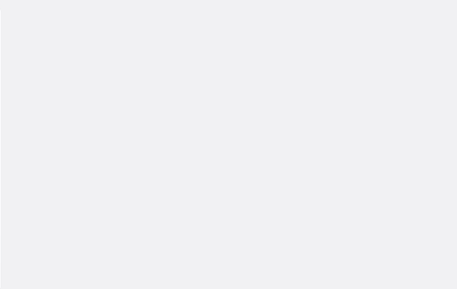
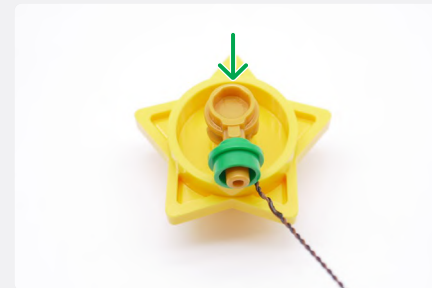
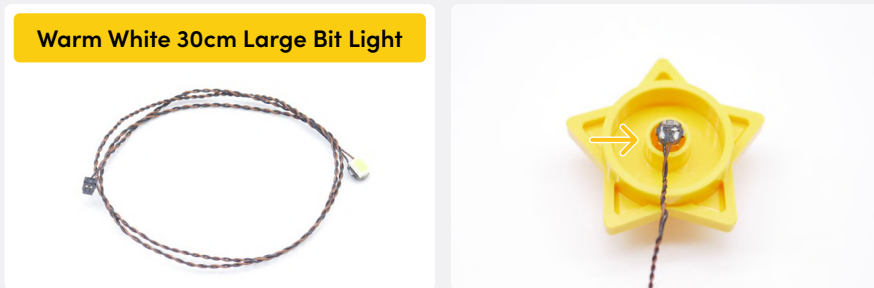



52

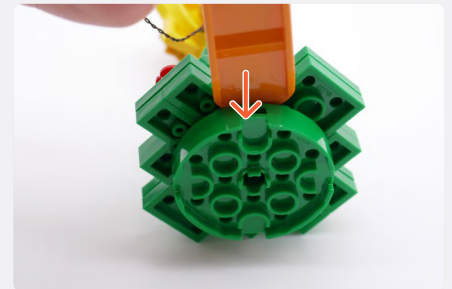
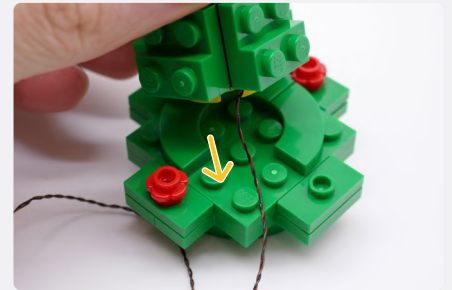
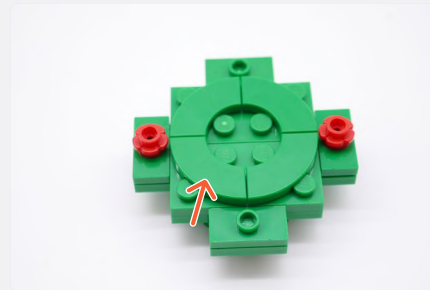
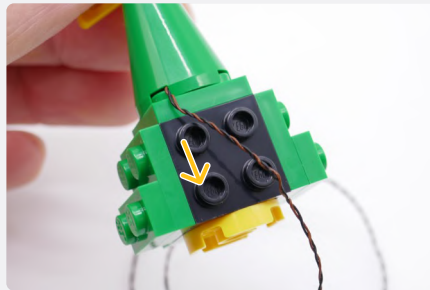
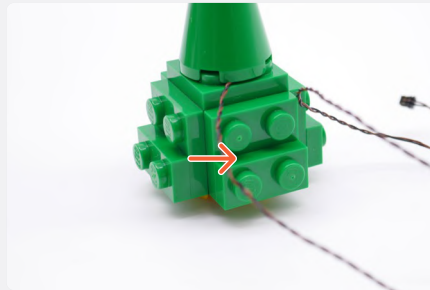

53

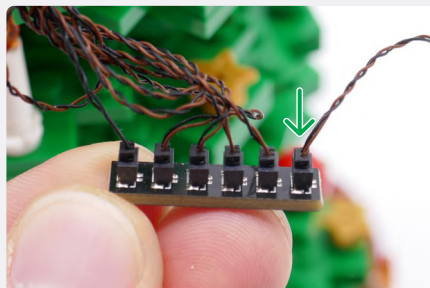
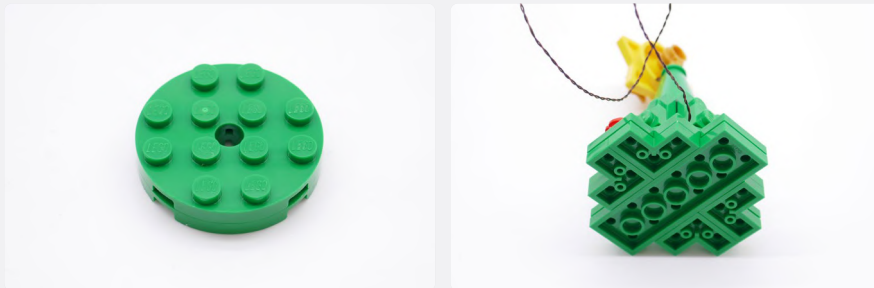



 **NOTE**

Connect to a 5V USB Power Bank, 5V USB Wall Adaptor, or USB to AA Battery Pack (sold separately)





! If you experience any issues with the lights not working and suspect an issue with a component, please try a different port on the expansion board to verify where the fault lies (with the light or expansion board). To correct any issues with expansion board ports, please view the section addressing expansion board issues in our troubleshooting section. i

NOTE

You should have these parts left over that were removed from the LEGO set.



ATTENTION

[Click Here](#) to skip to the Final Product page, Troubleshooting, and Contact.



INSTRUCTIONS

The following section is for the “Medium and Small Tree” variant. To light up the “Large Tree”, go back to Page 12 or [click here](#).

To ensure a smooth installation of your light kit, please read and follow each step carefully. If you run into any issues, please refer to the online troubleshooting guide.



1



2



USB Power Cable

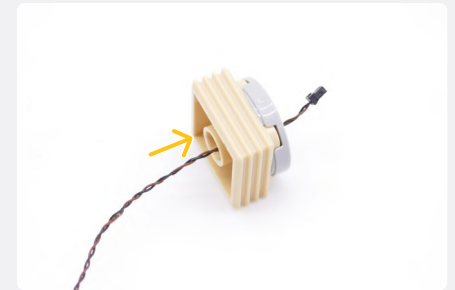

NOTE

Place back down the tan brick but do not fully connect it yet.

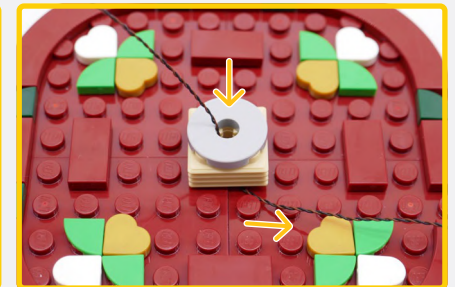

NOTE

Pull the USB Power Cable up and leave around 10cm of length.



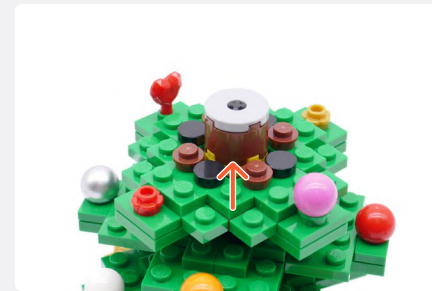
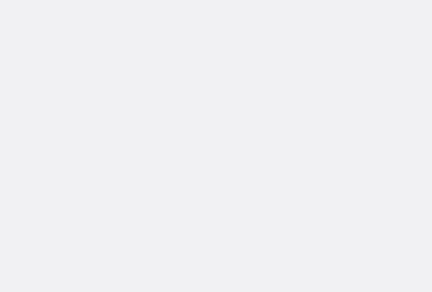
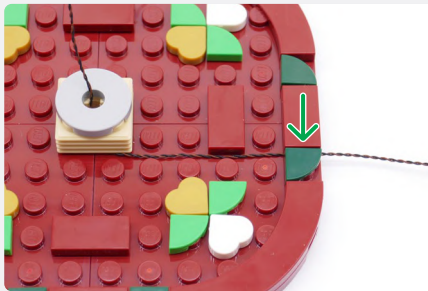
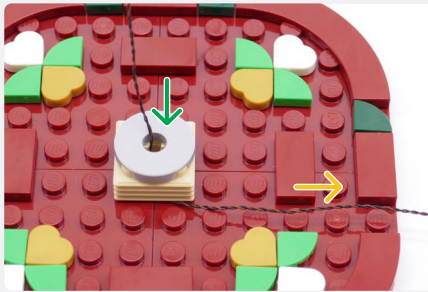

3

4



5

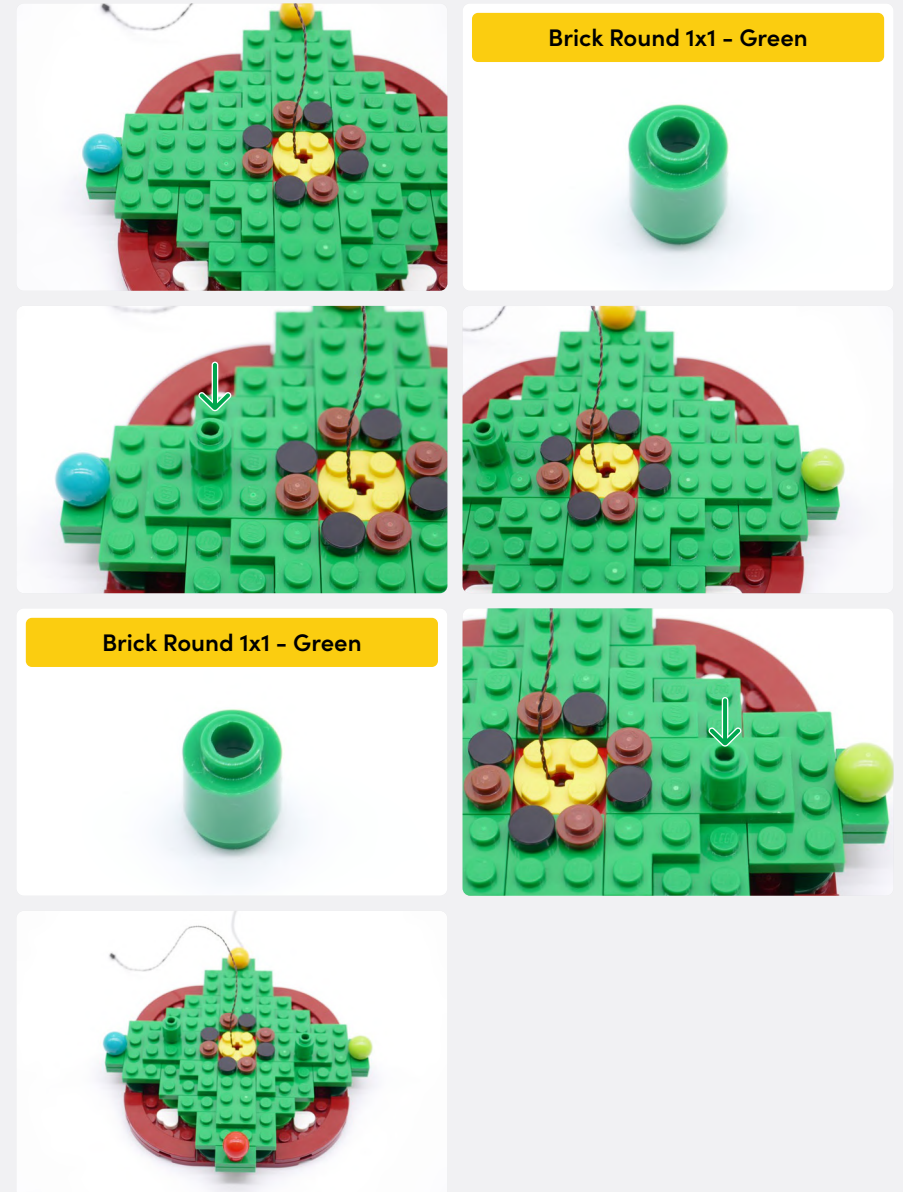

6

Brick Round 1x1 - Trans Clear



Green 30cm Bit Light



7



NOTE

Ensure the trans clear and green round bricks are properly connected.

8

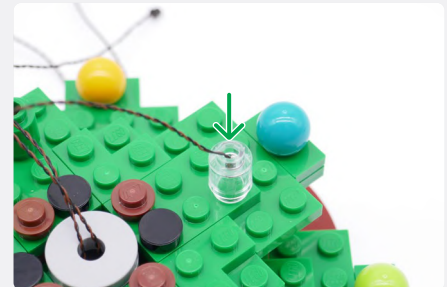
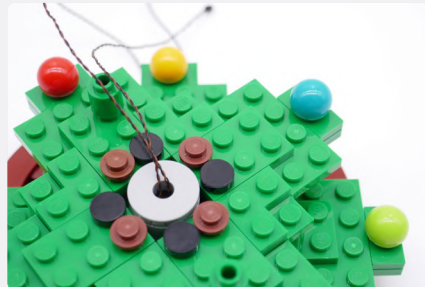
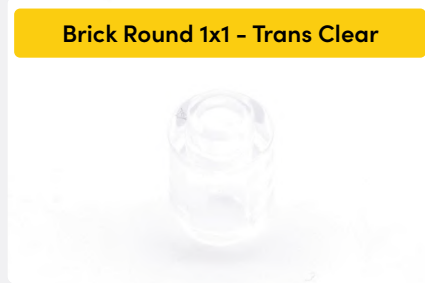
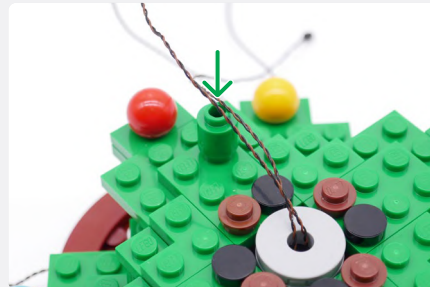
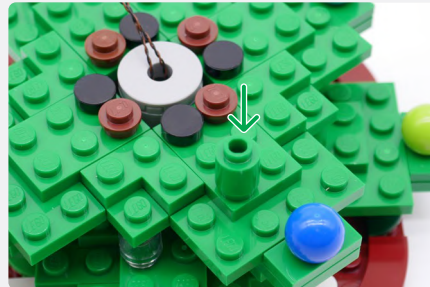
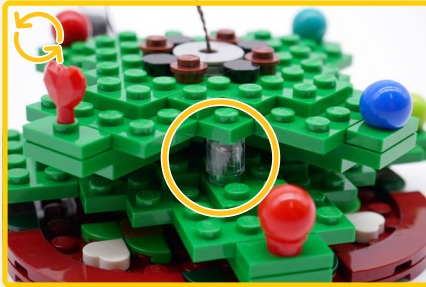

9

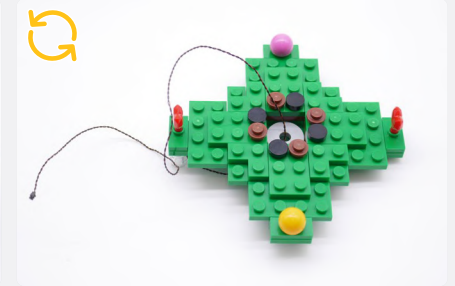
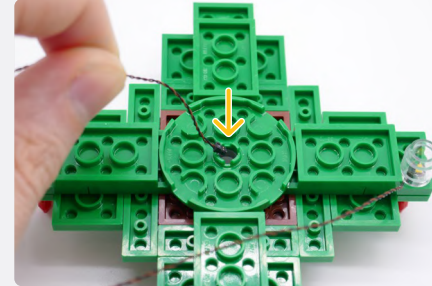
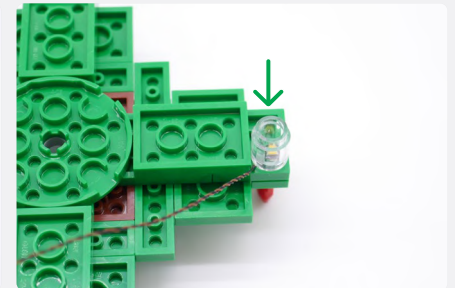
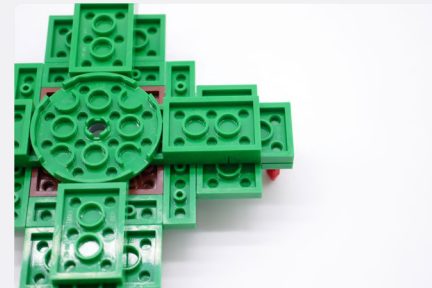
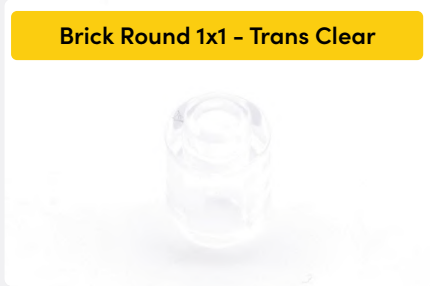

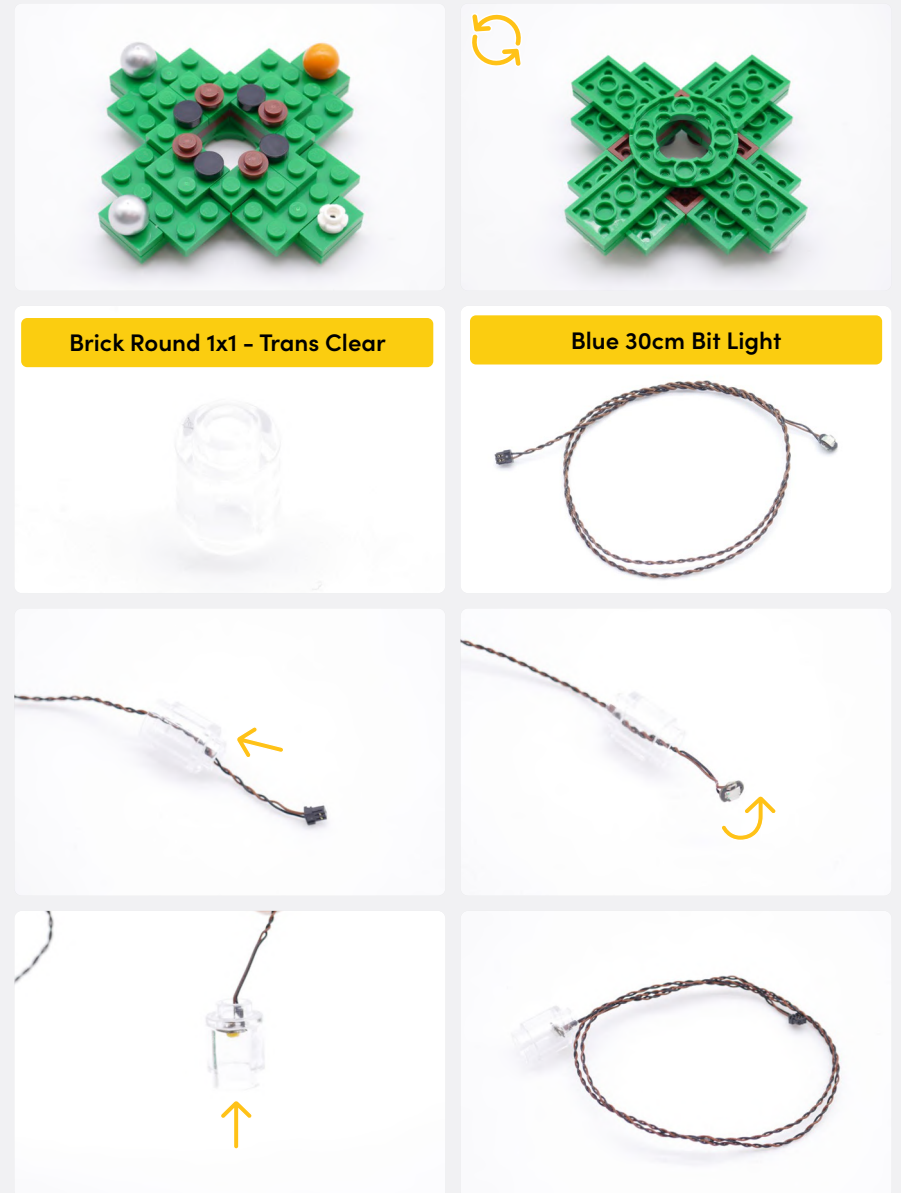
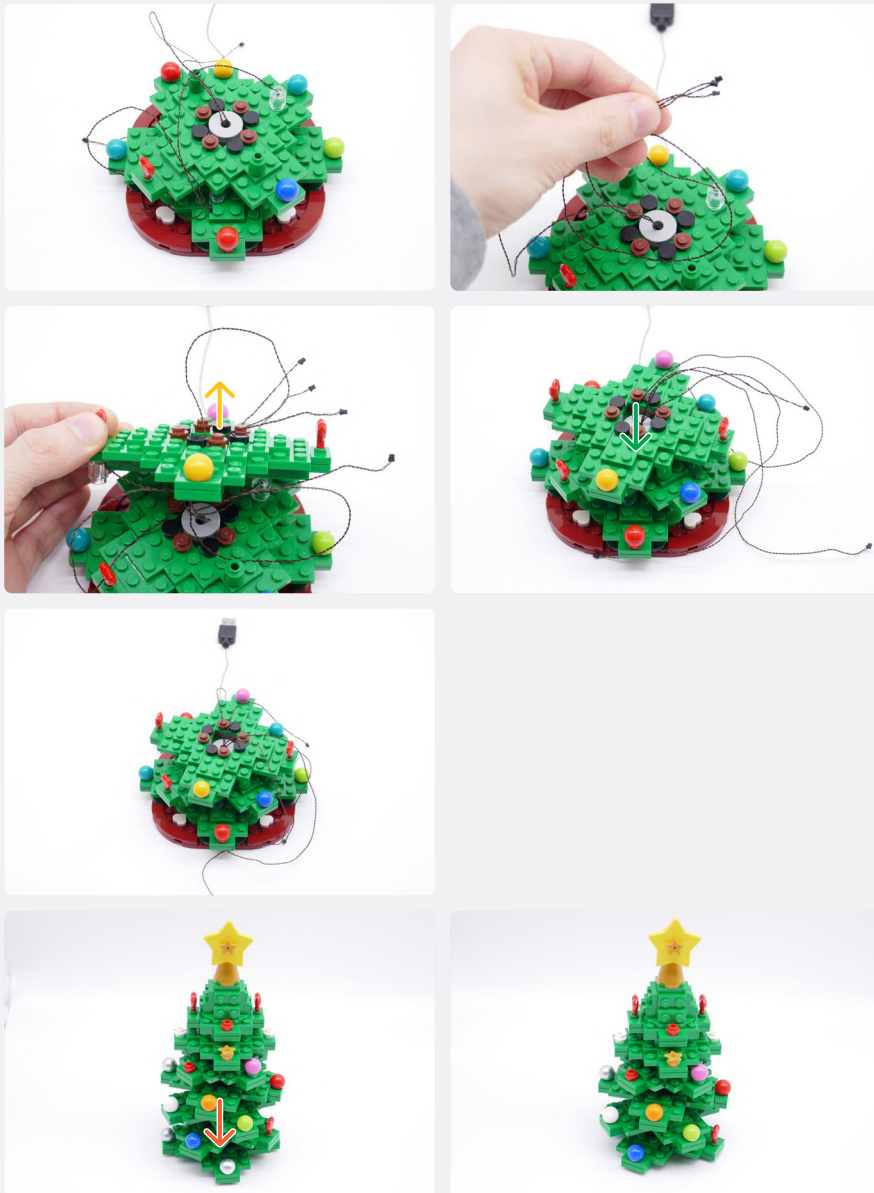

11

12

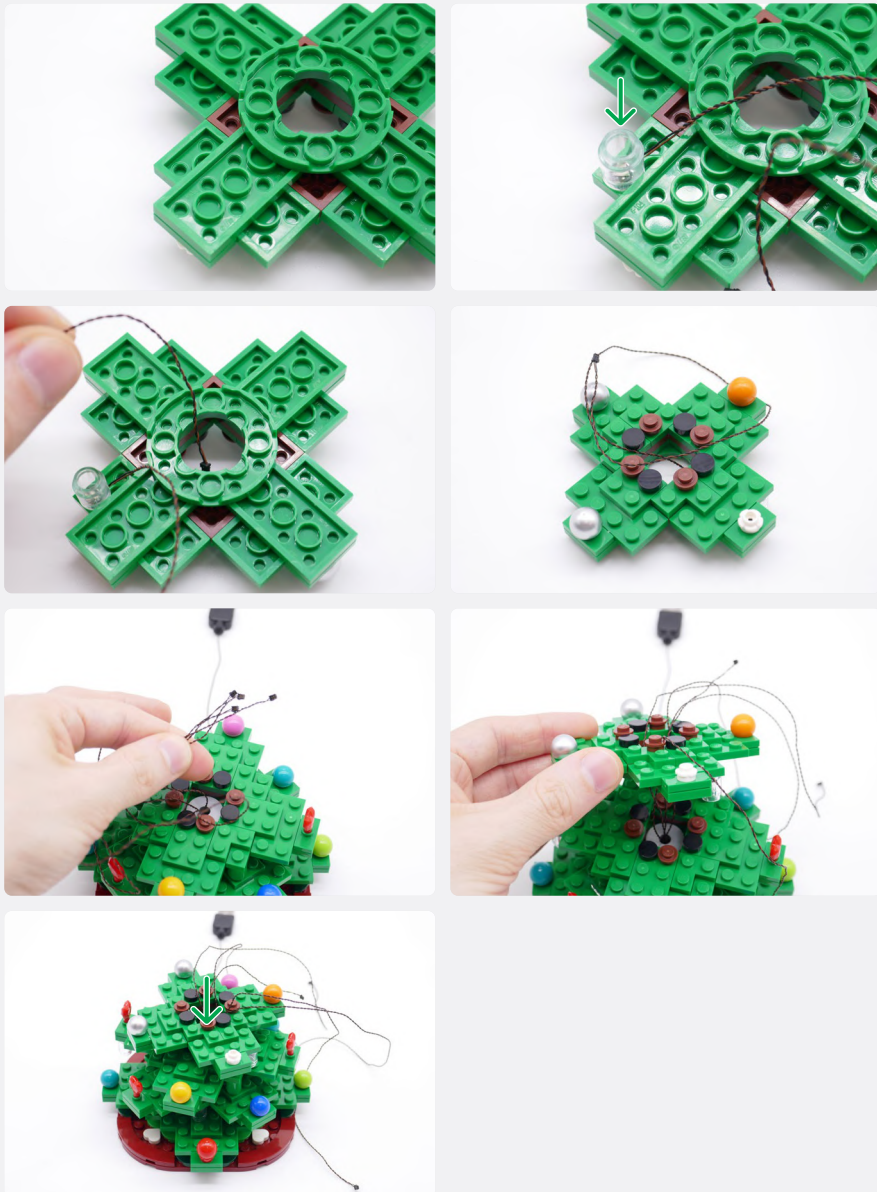

Brick Round 1x1 - Trans Clear

Red 30cm Bit Light



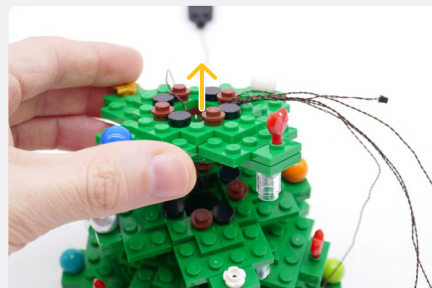
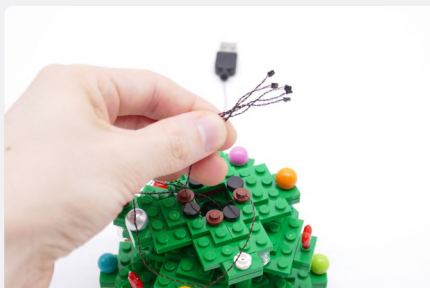
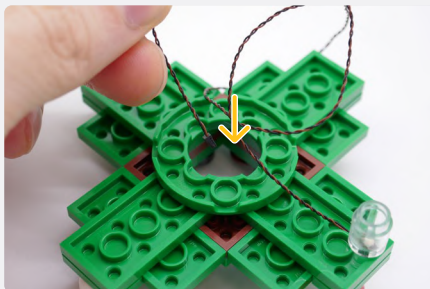
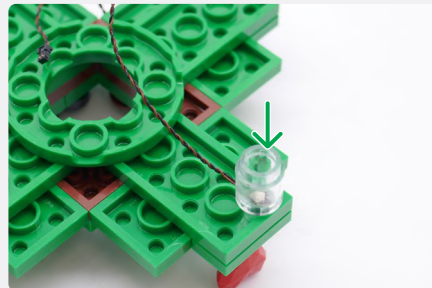
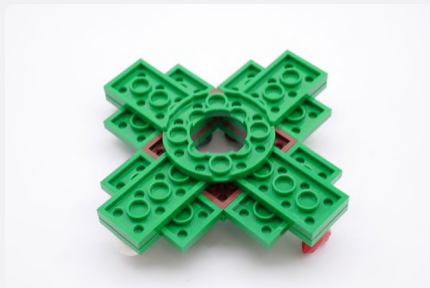

13

NOTE

Take the USB Power Cable (shortest one) and connect it to a 12-Port Expansion Board.

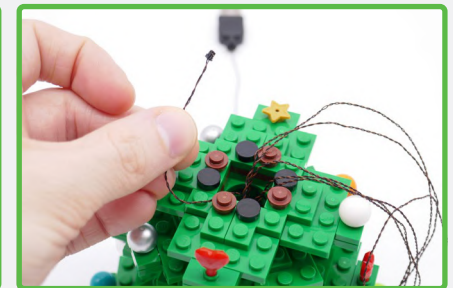

12-Port Expansion Board

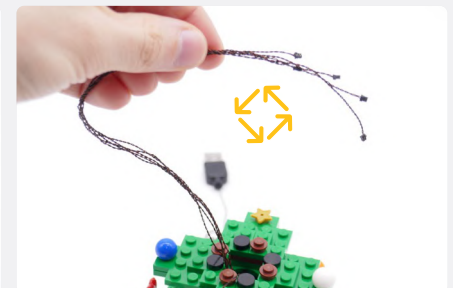
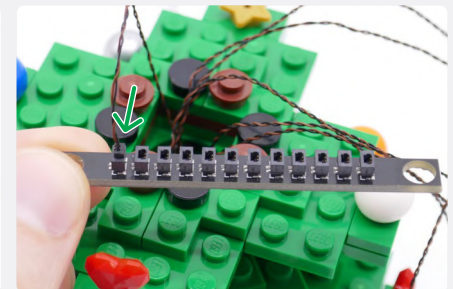

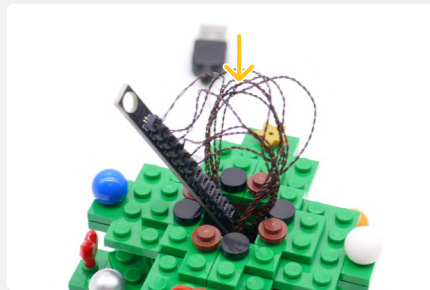
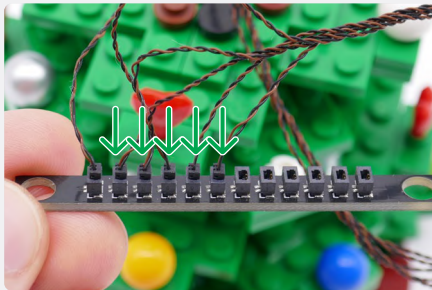

! If you experience any issues with the lights not working and suspect an issue with a component, please try a different port on the expansion board to verify where the fault lies (with the light or expansion board). To correct any issues with expansion board ports, please view the section addressing expansion board issues in our troubleshooting section. i



 **NOTE**
Connect to a 5V USB Power Bank, 5V USB Wall Adaptor, or USB to AA Battery Pack (sold separately)

14

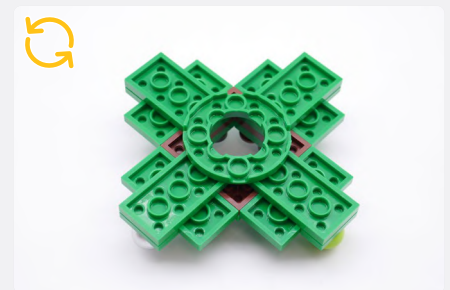
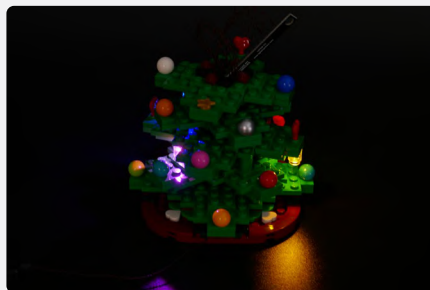

Brick Round 1x1 - Trans Clear



Blue 30cm Bit Light

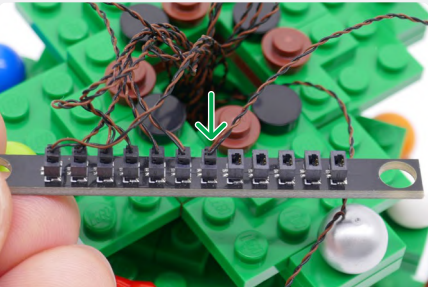
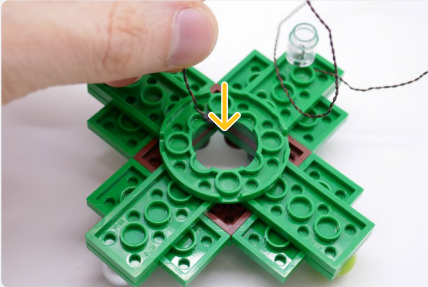
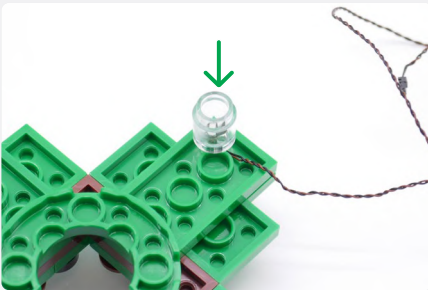

15



Brick Round 1x1 - Trans Clear

Green 30cm Bit Light

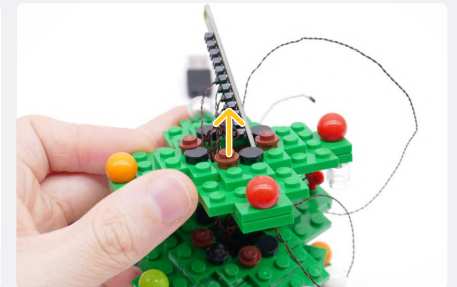
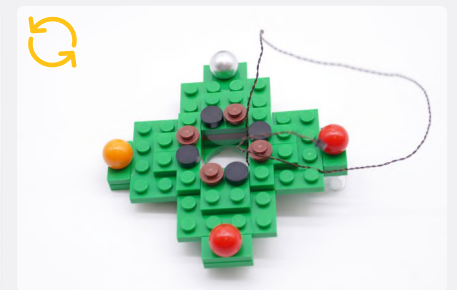
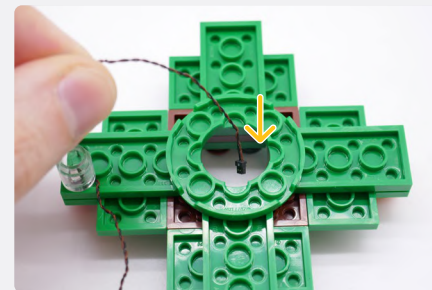
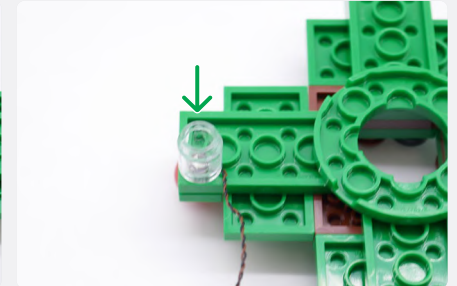
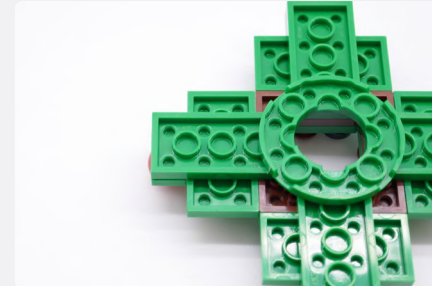

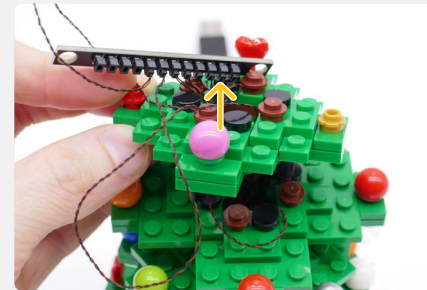
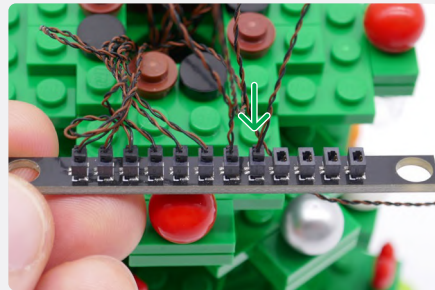

16



17



Brick Round 1x1 - Trans Clear



Pink 30cm Bit Light

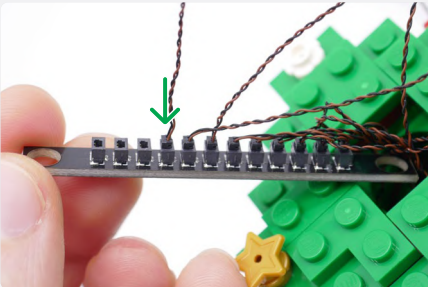
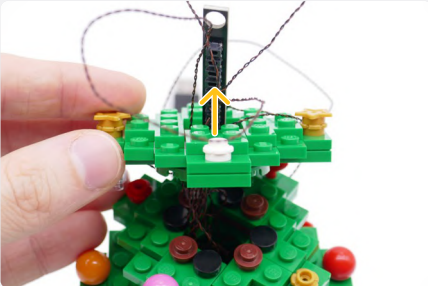
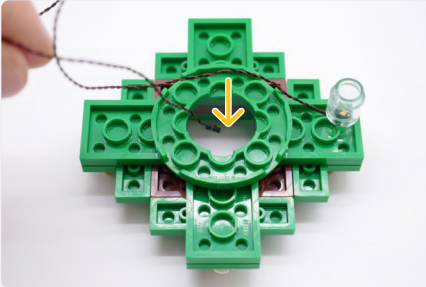
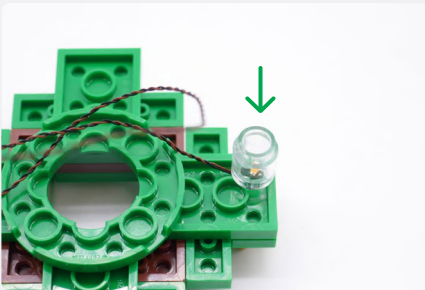
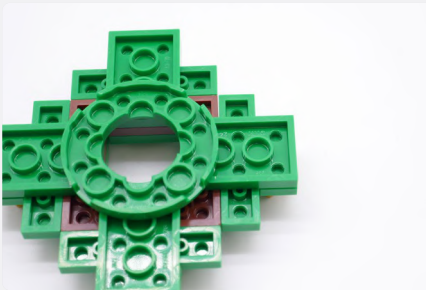

18

Brick Round 1x1 - Trans Clear

Red 30cm Bit Light

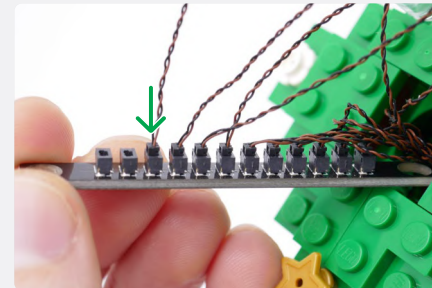
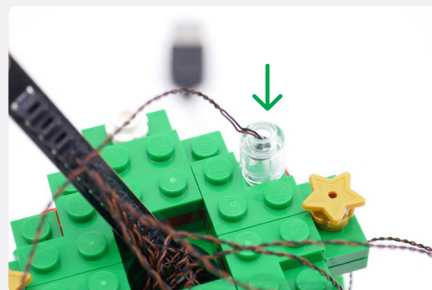

19



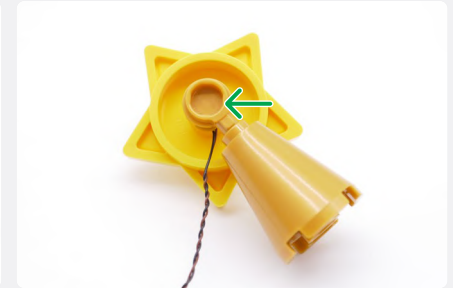
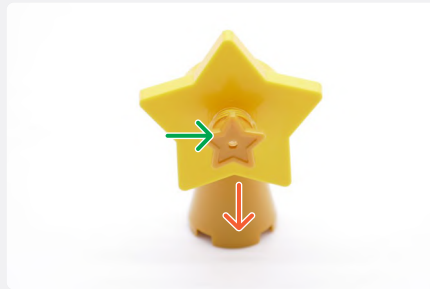
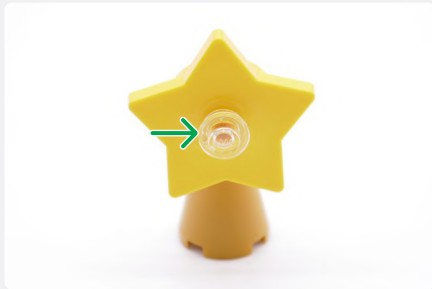
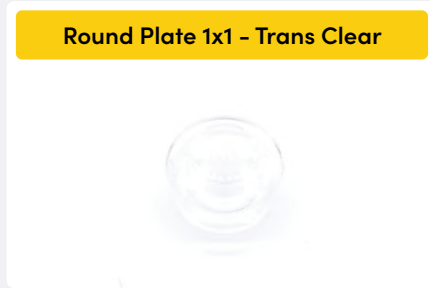
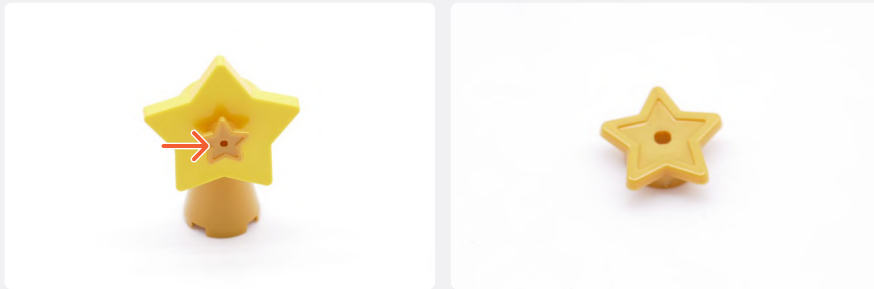

20

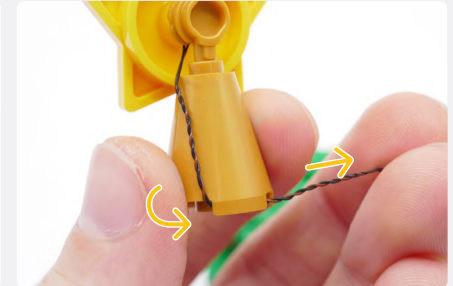

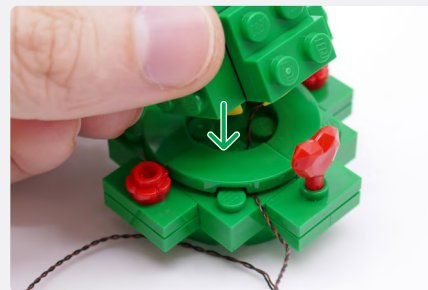
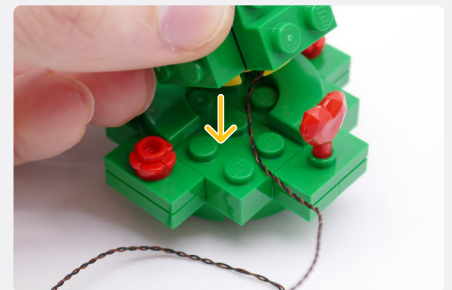
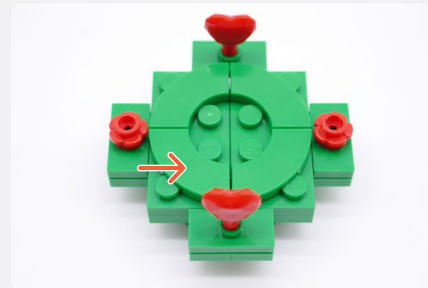
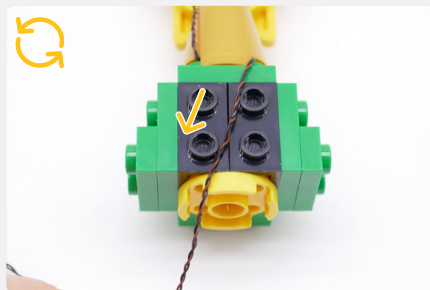
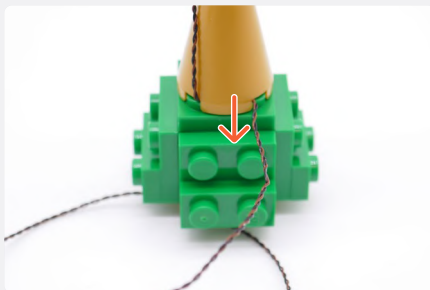

21

22

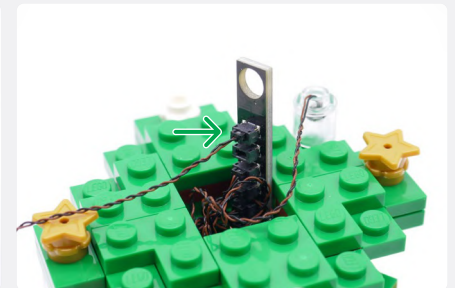
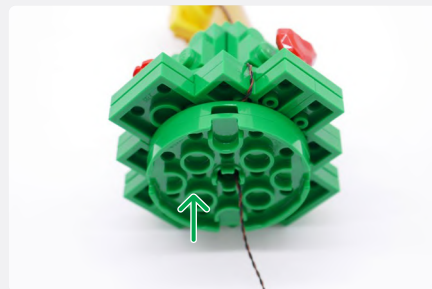
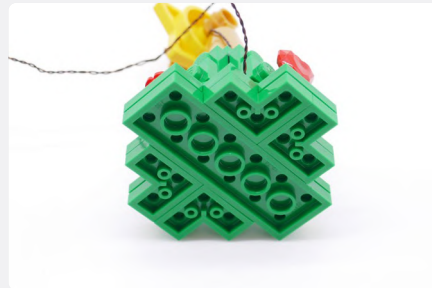
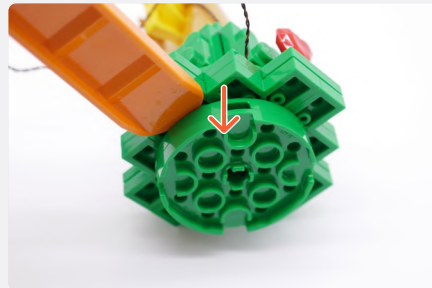

NOTE

Press the Expansion Board down into the hole, but do NOT force it. Move the Board around slightly to work your way down through the cables.

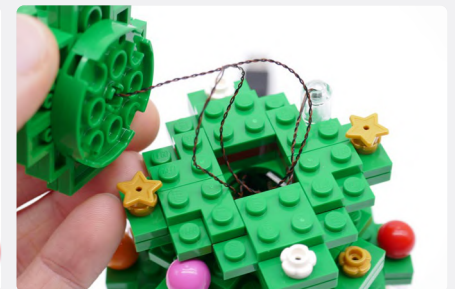
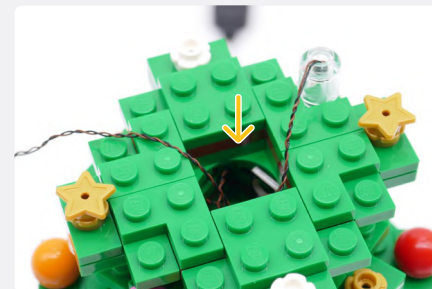



 **NOTE**

Connect to a 5V USB Power Bank, 5V USB Wall Adaptor, or USB to AA Battery Pack (sold separately)



! If you experience any issues with the lights not working and suspect an issue with a component, please try a different port on the expansion board to verify where the fault lies (with the light or expansion board). To correct any issues with expansion board ports, please view the section addressing expansion board issues in our troubleshooting section. **i**

 **NOTE**

You should have these parts left over that were removed from the LEGO set



23

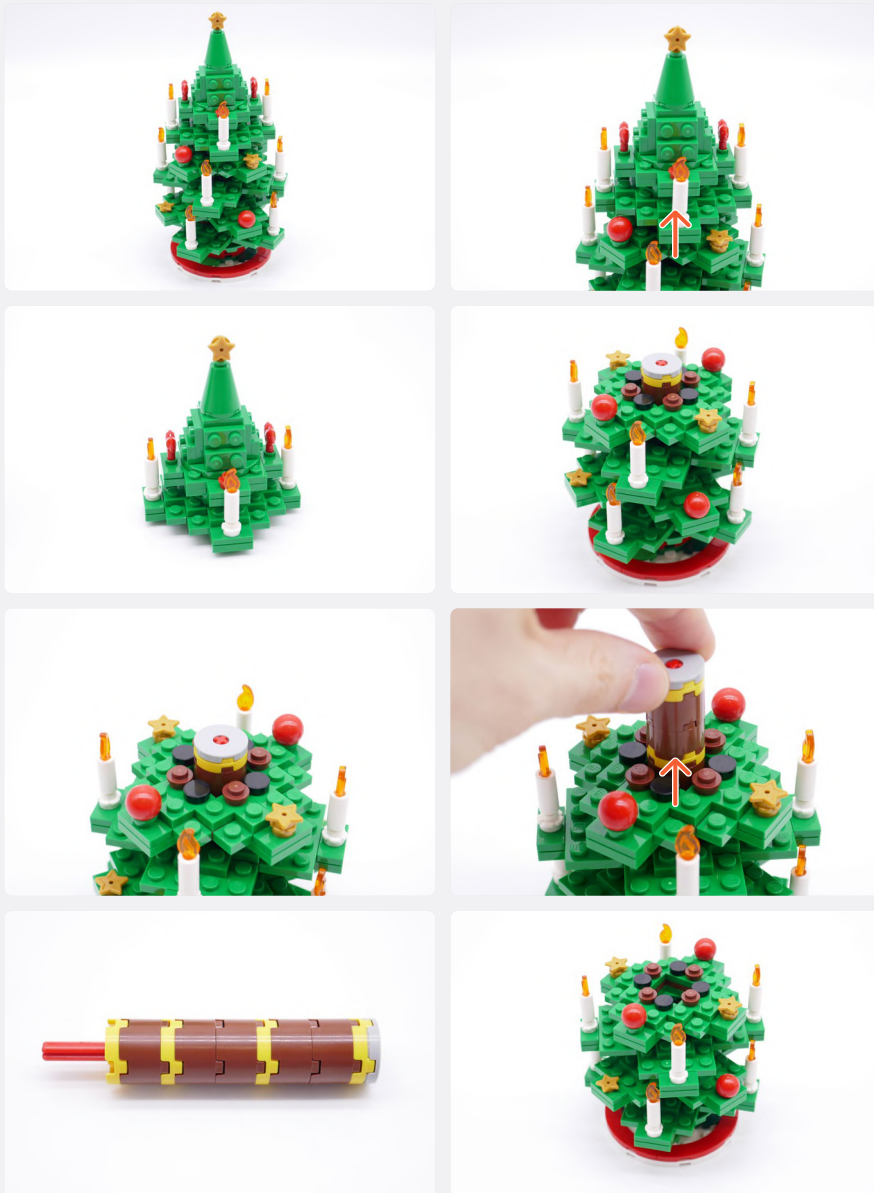

23





NOTE

Place the pieces back down but do not connect. Pull up the USB Power Cable to leave around 10cm of length.

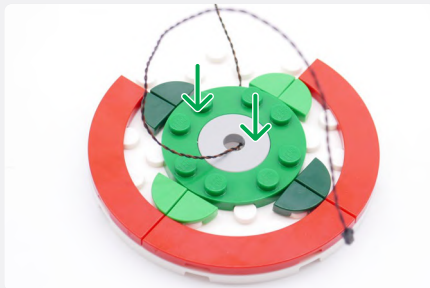
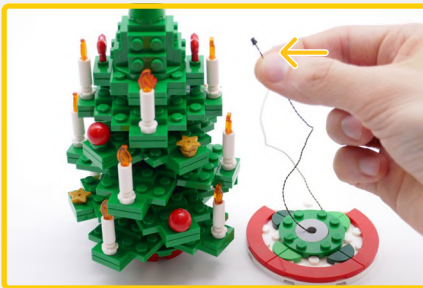
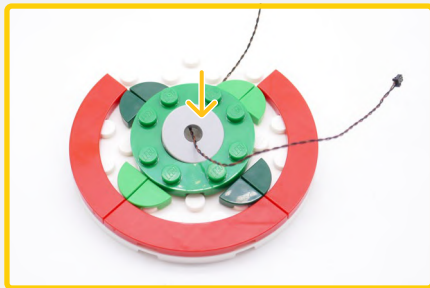

24

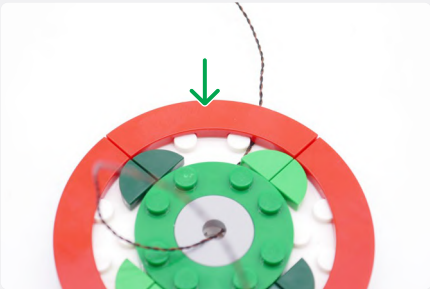

25

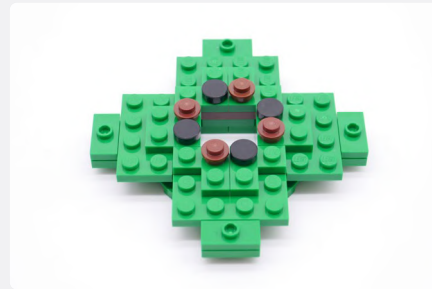
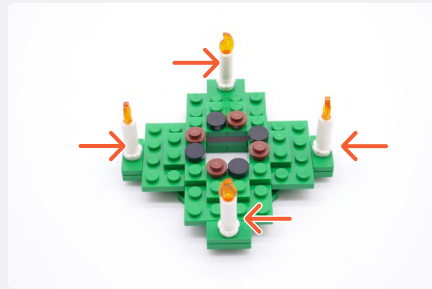
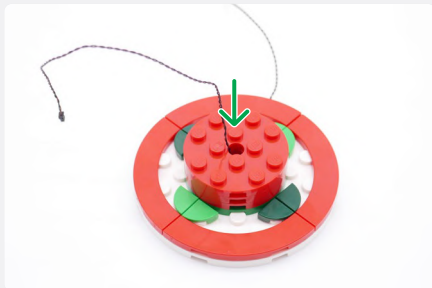

White 30cm Micro Bit Light



NOTE

Position the Micro Bit Light as shown, holding it in place when reconnecting the piece.

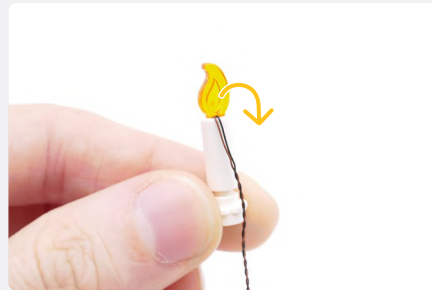
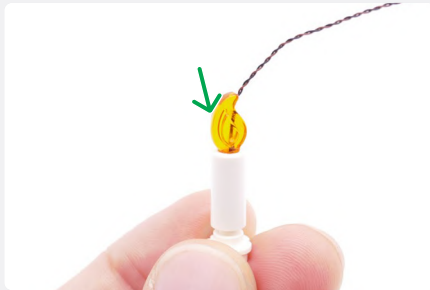
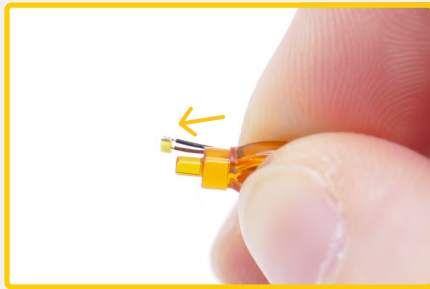

26

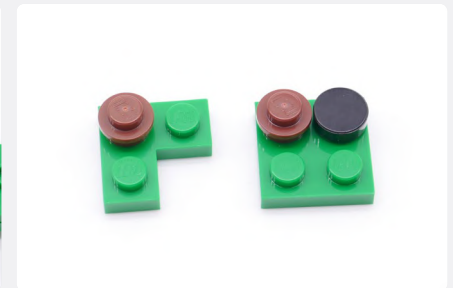
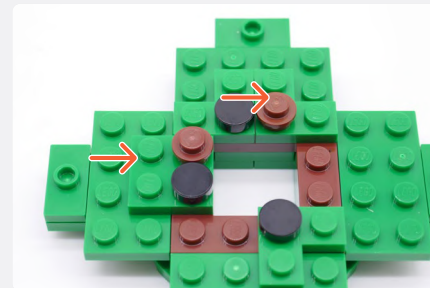
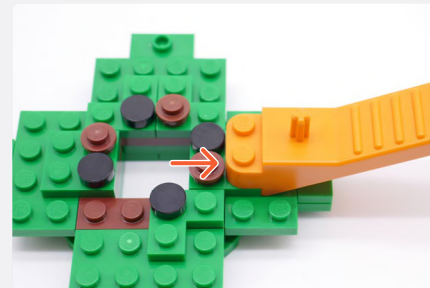
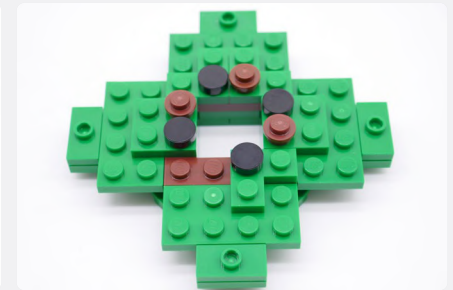
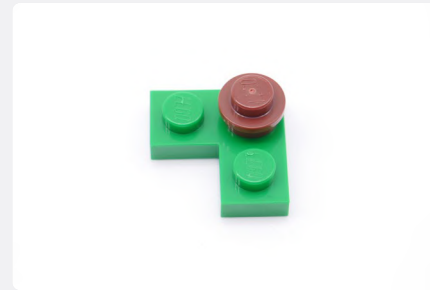
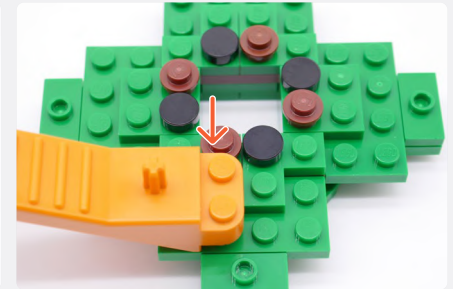
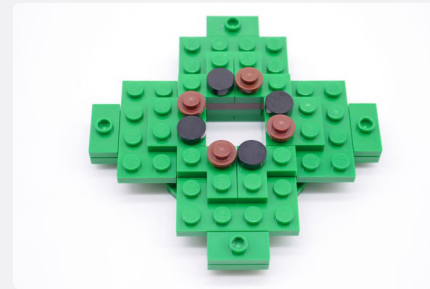

27

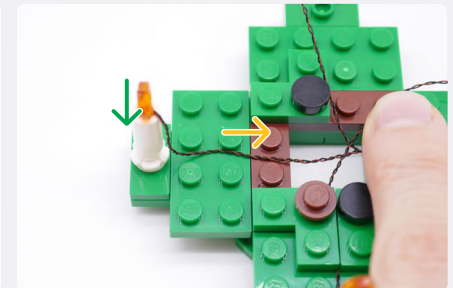
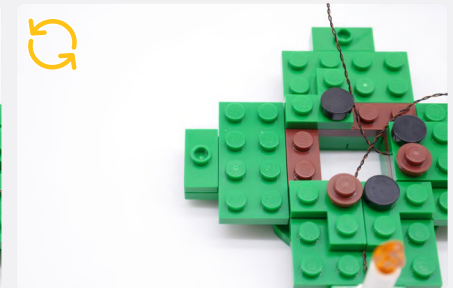
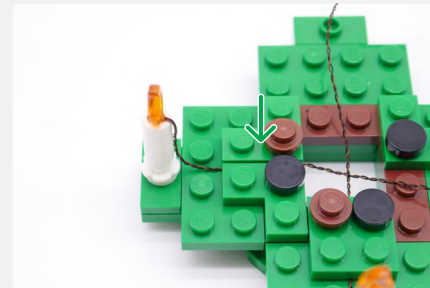
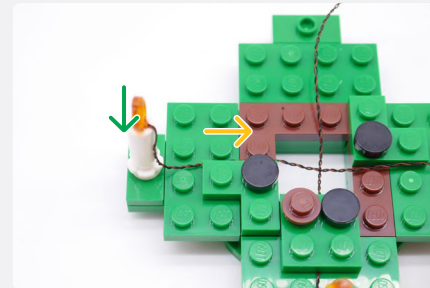
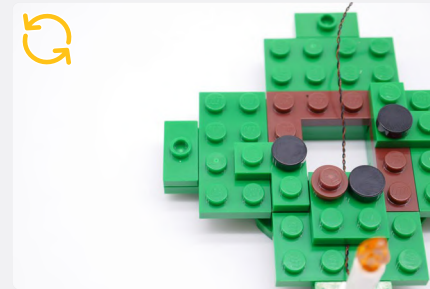
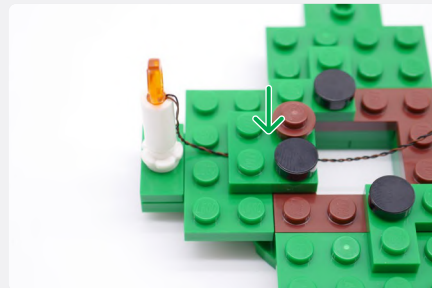
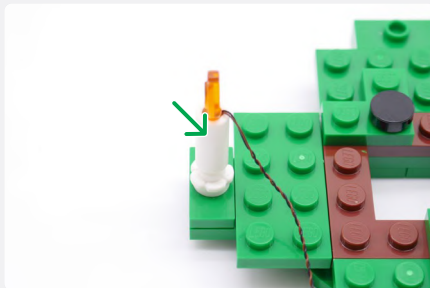
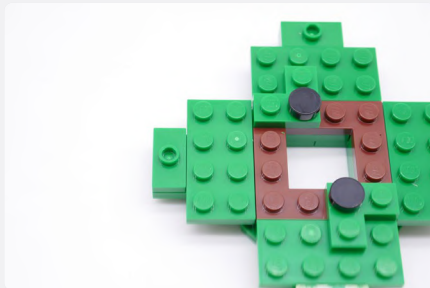
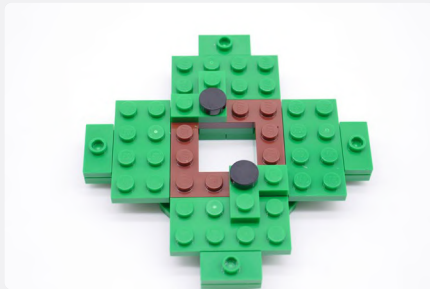

28

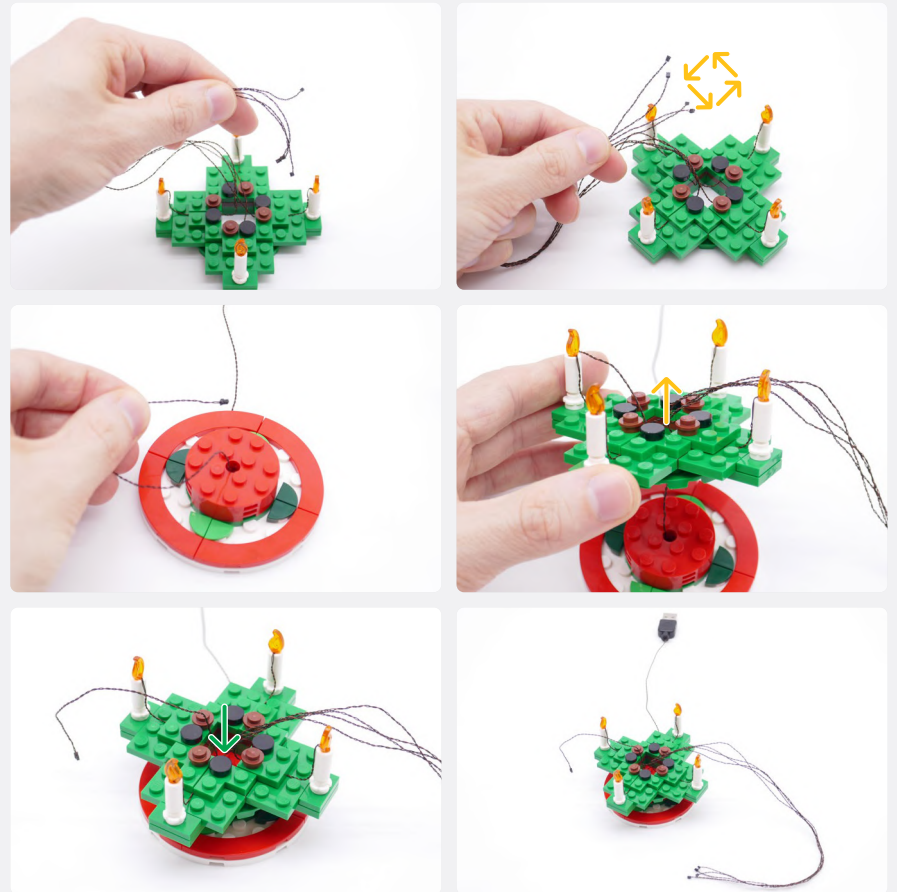
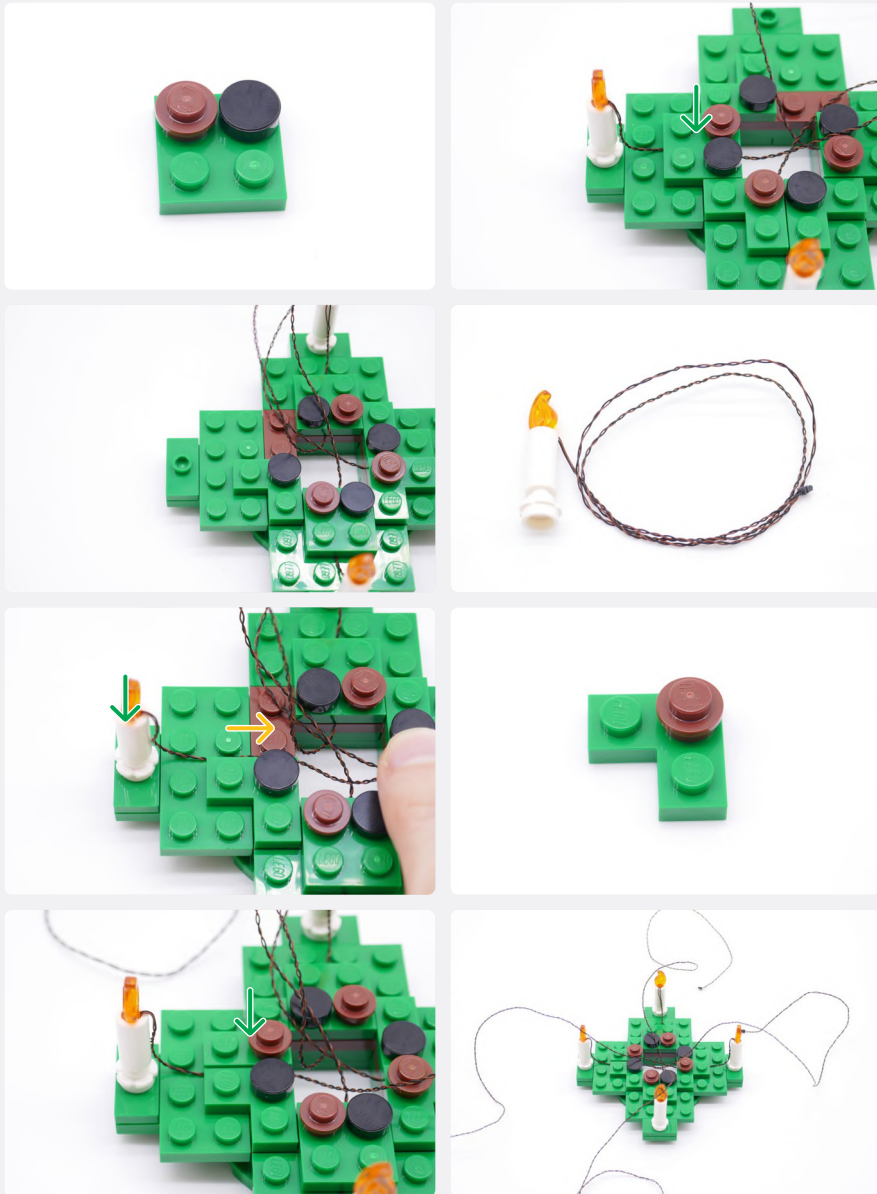

29

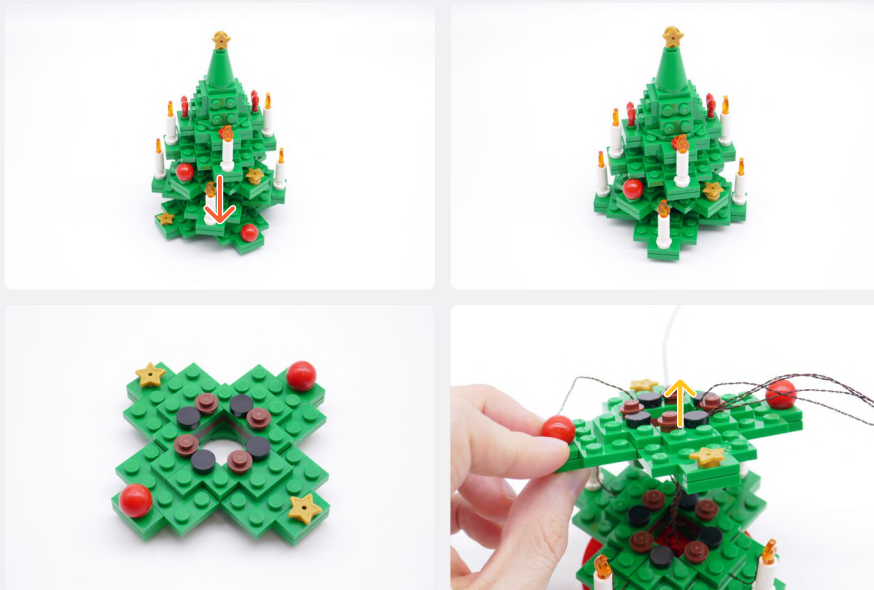

30

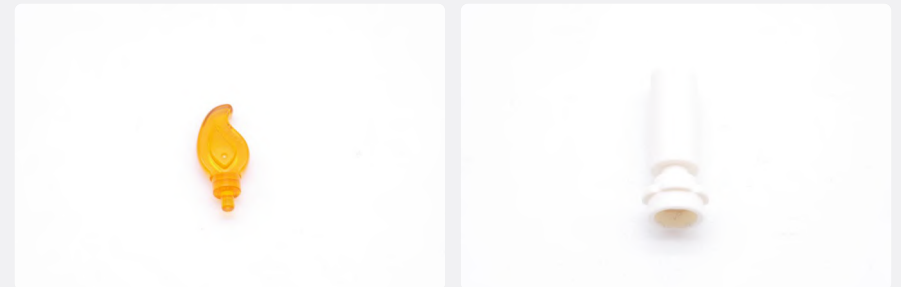
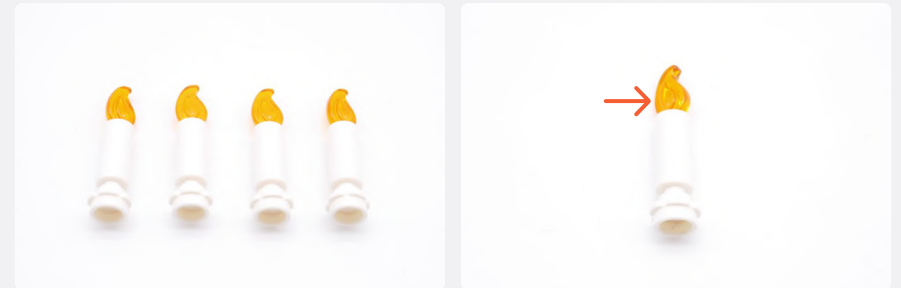
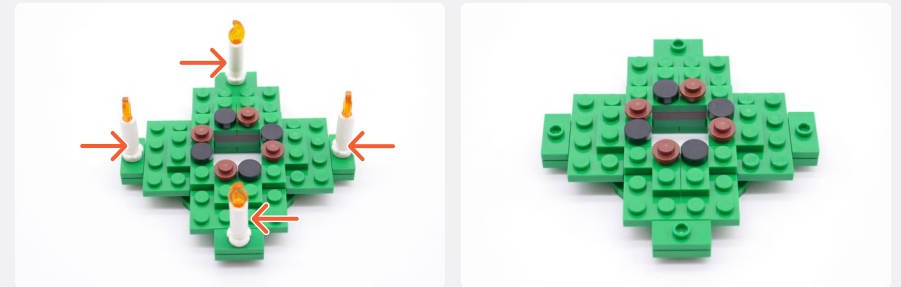
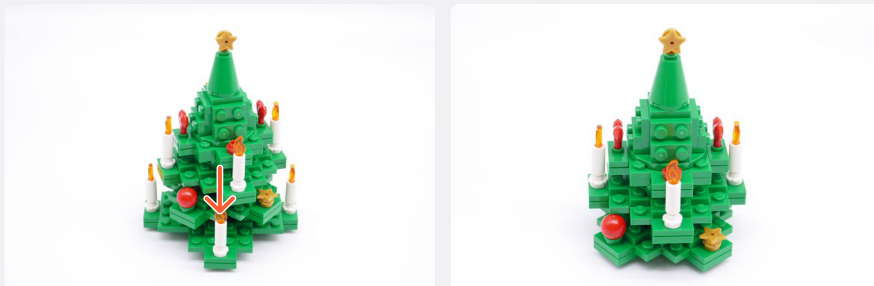

White 15cm Micro Bit Light

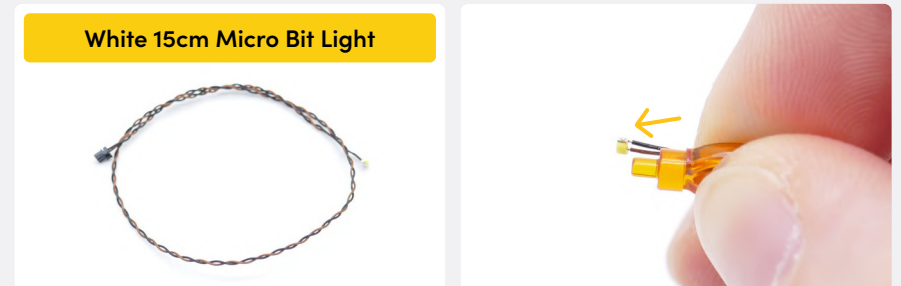

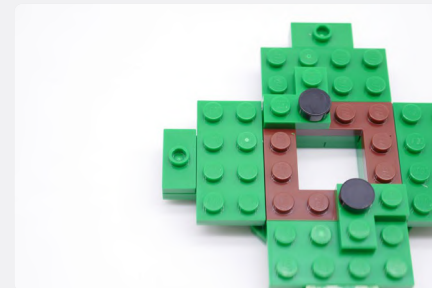
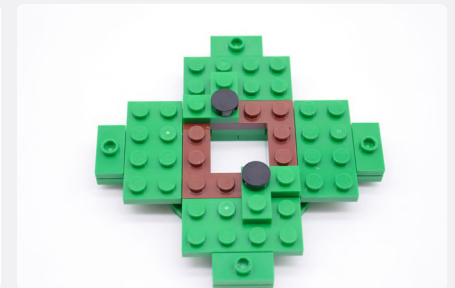
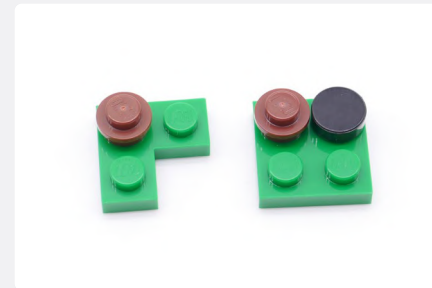
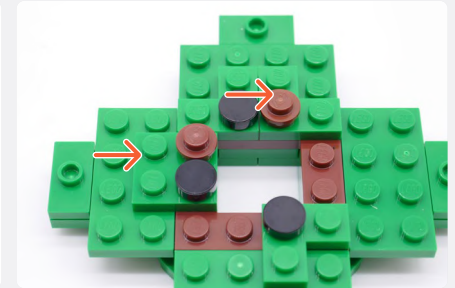
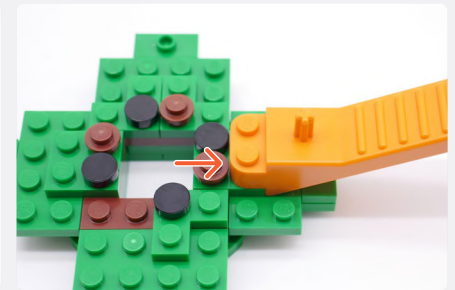
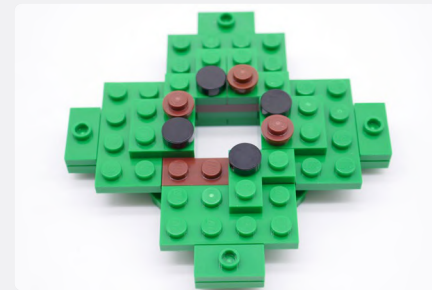
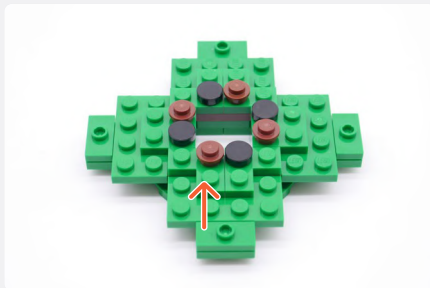
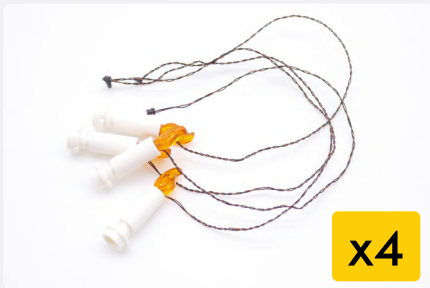
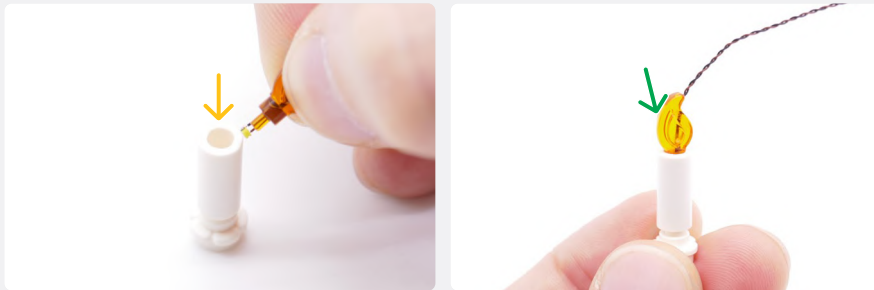

31

32

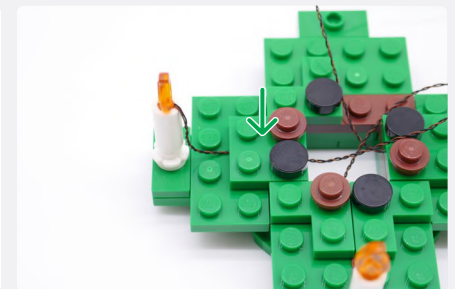
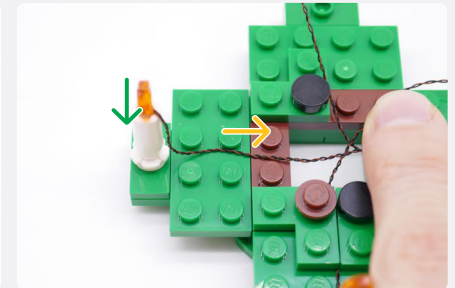
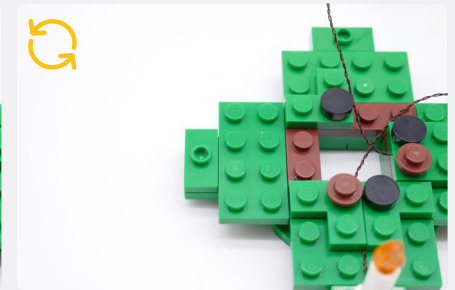
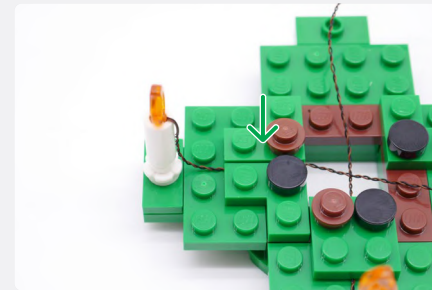
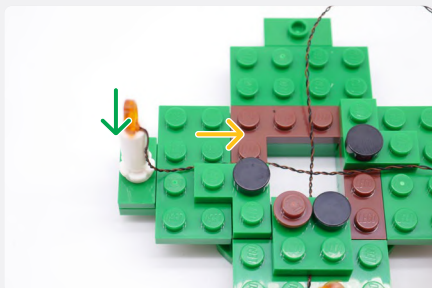
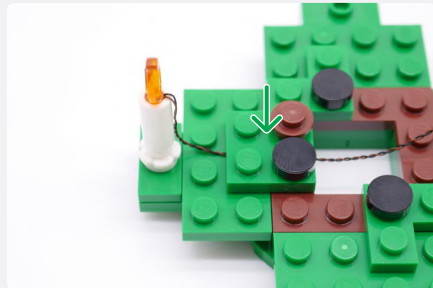
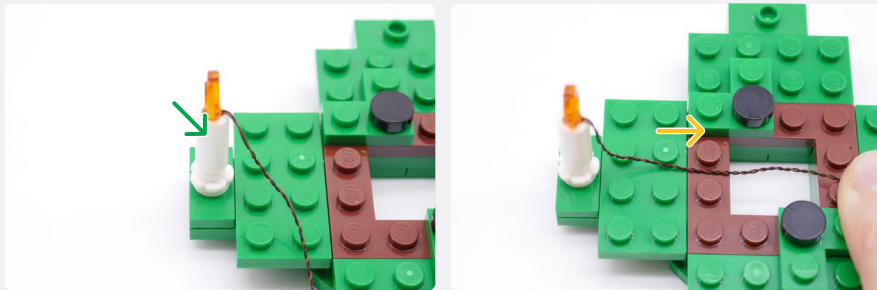

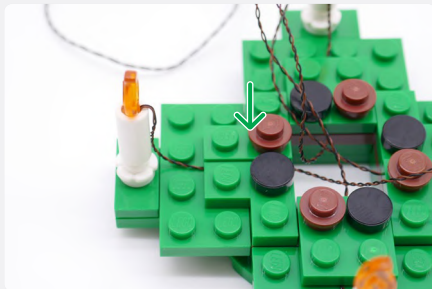
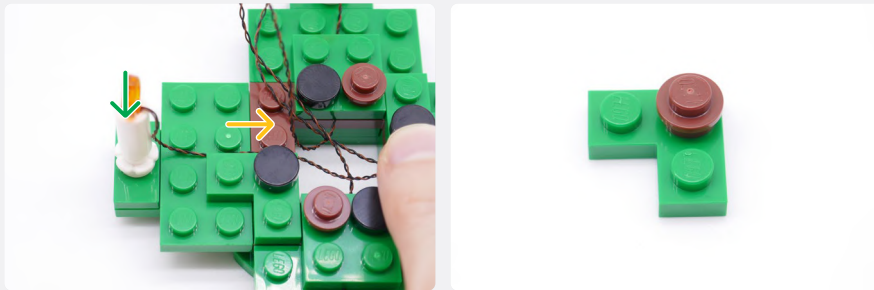

NOTE

Take the 4 White 30cm Micro Bit Lights (longer cables) and connect them to an 8-Port Micro Expansion Board.

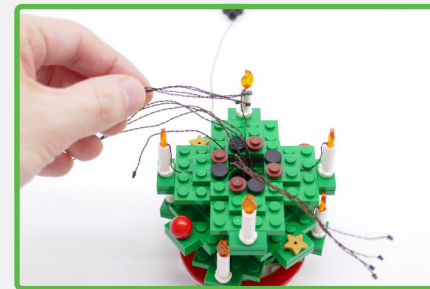

8-Port Micro Expansion Board

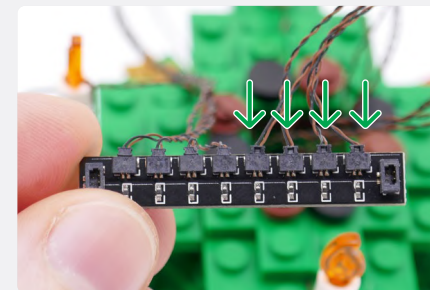
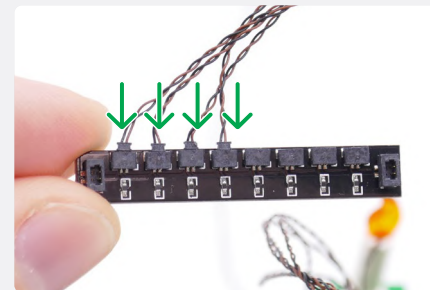

33

34



6-Port Expansion Board

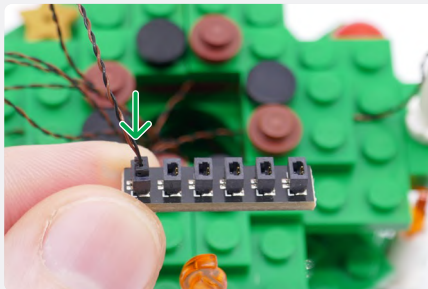
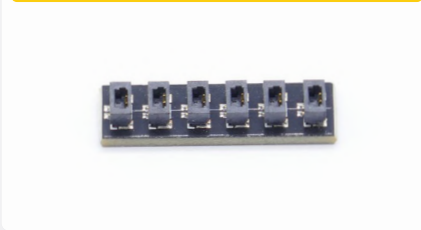



15cm Connecting Cable

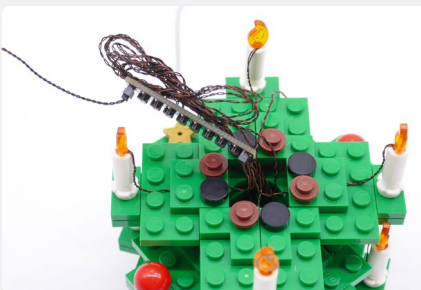
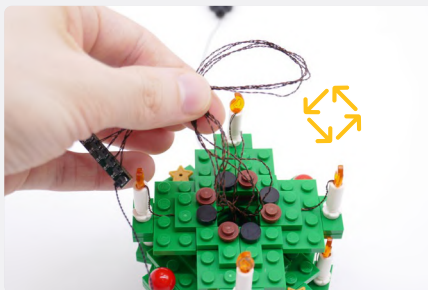
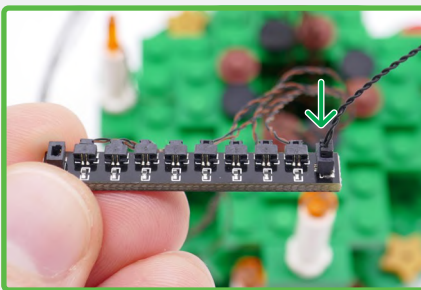

 **NOTE**

Connect the 5cm Connecting Cable into 8-Port Micro Expansion Board.



 **NOTE**

Push the Board into the hole, but do NOT force it. Move the Board around to get past the cables.

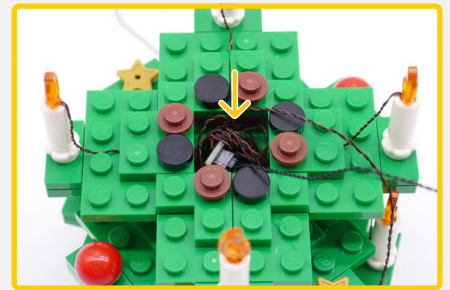

35

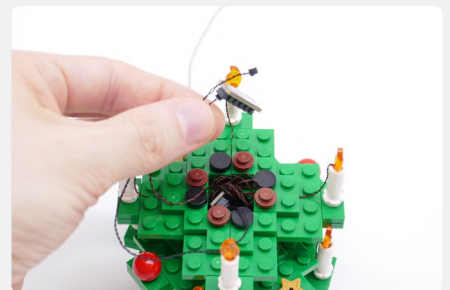

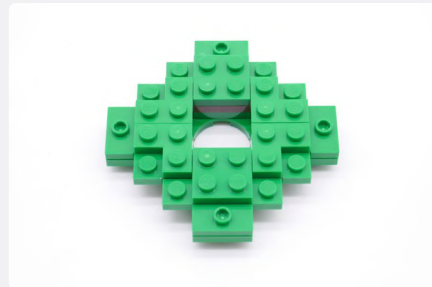
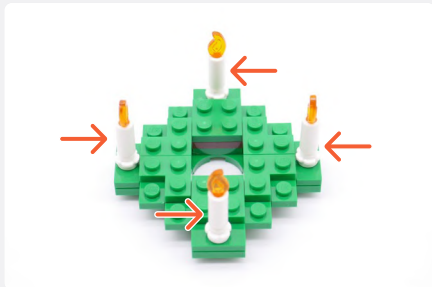

White 15cm Micro Bit Light

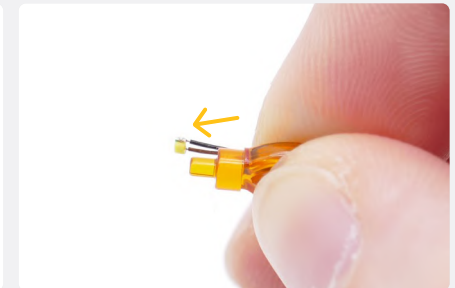

36



x4

37

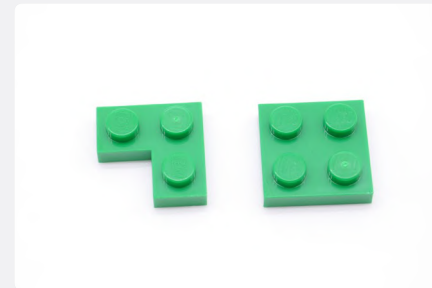
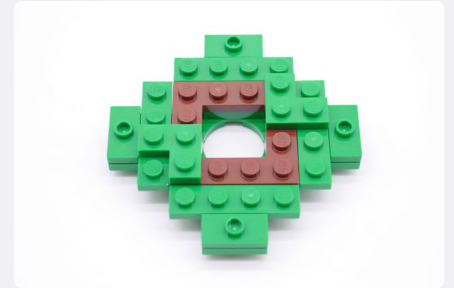
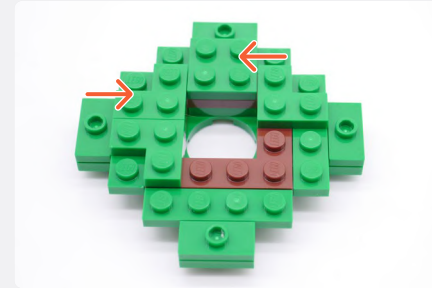
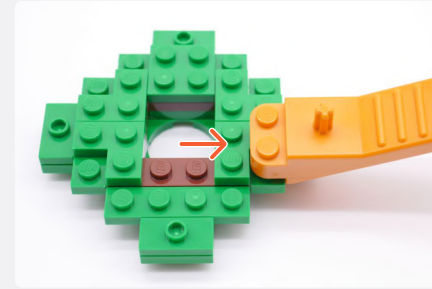
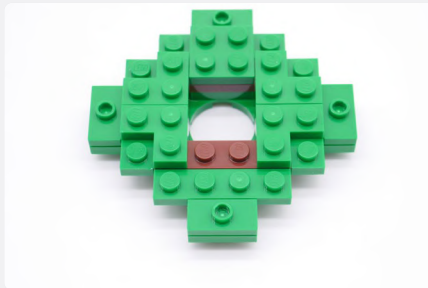
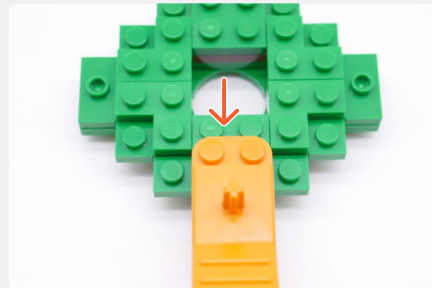

38



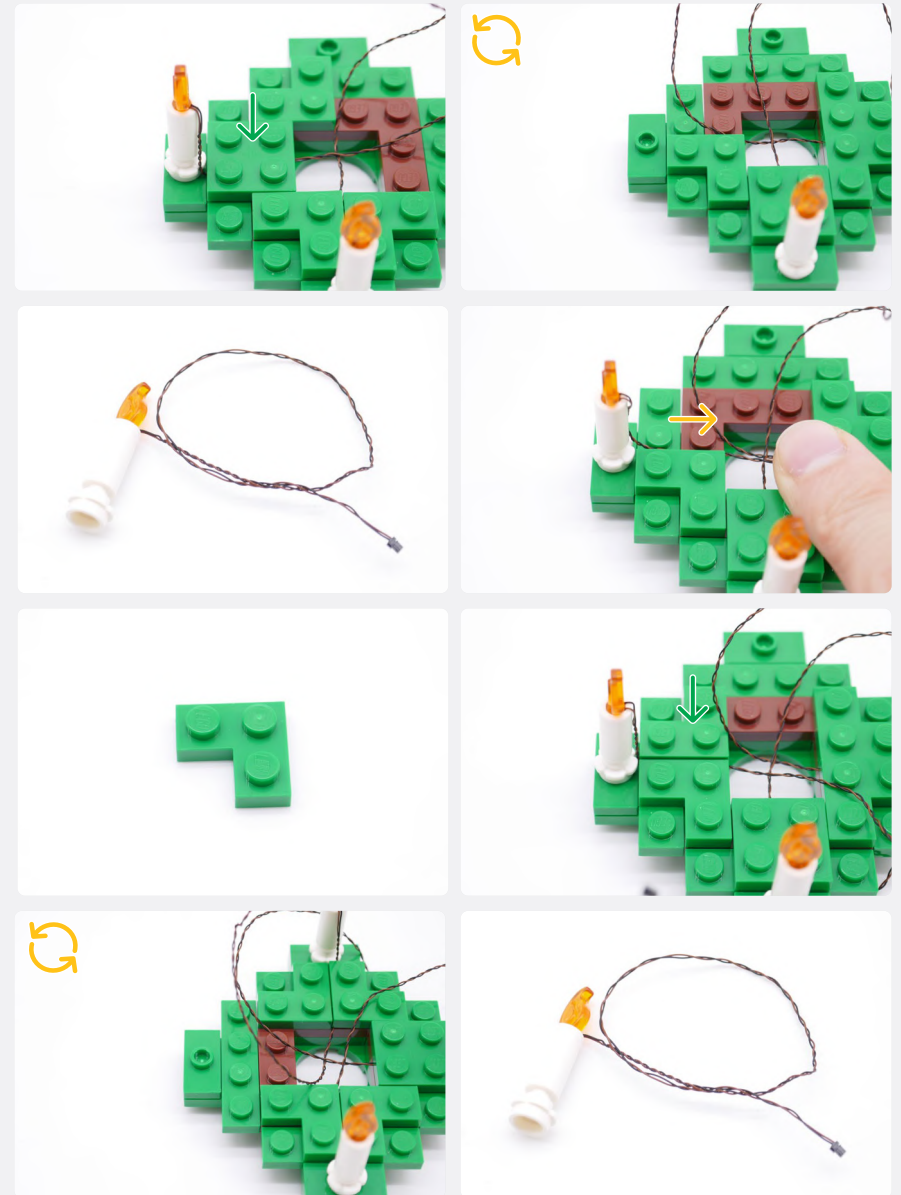
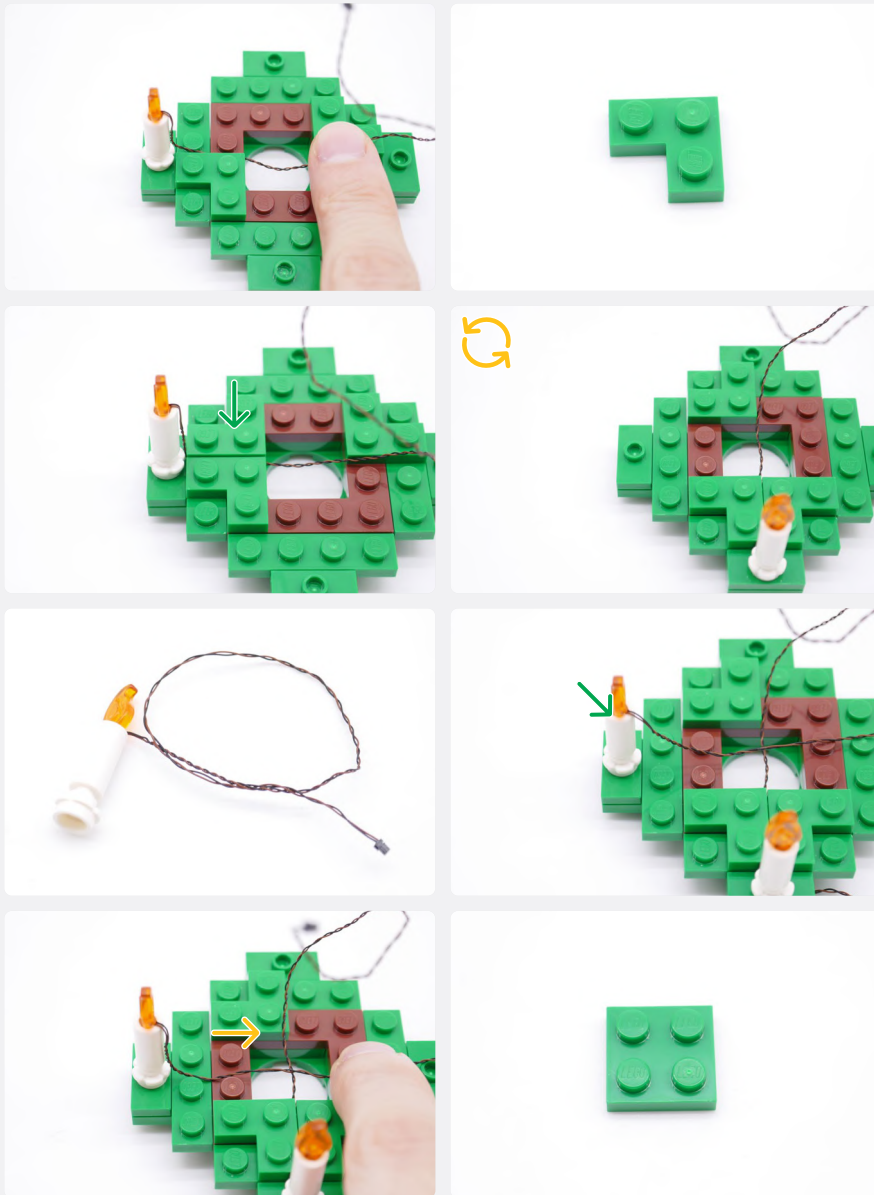

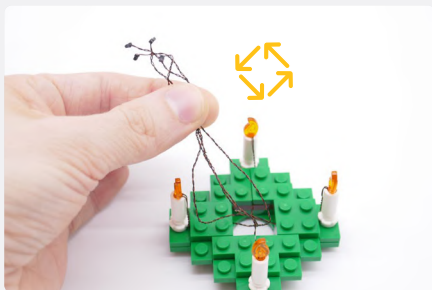
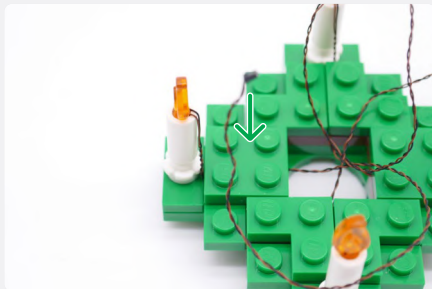
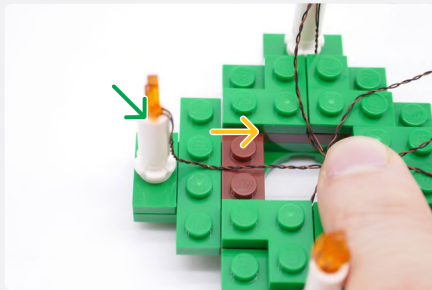

39

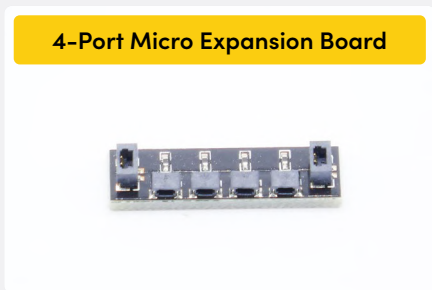

4-Port Micro Expansion Board

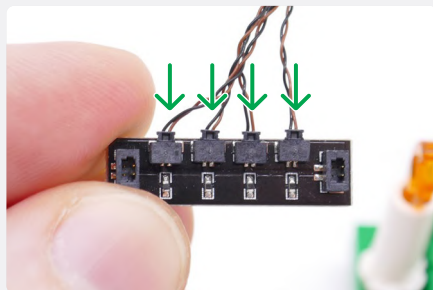

40



5cm Connecting Cable



NOTE

Connect a 5cm Connecting Cable into the 4-Port Micro Expansion Board.

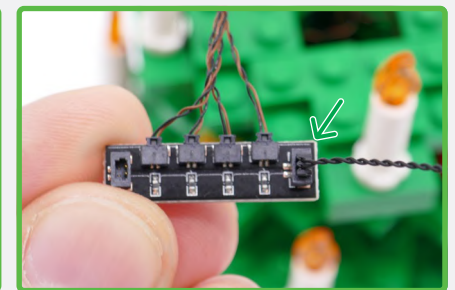

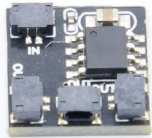
Flicker Effects Board

NOTE

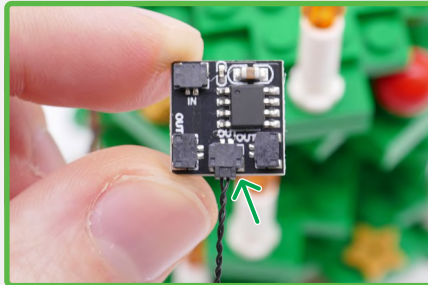
Connect the other end of the 5cm Connecting Cable into the "OUT" port of the Flicker Effects Board.



NOTE

Take the 15cm Connecting Cable and connect it into the "OUT" port of the Flicker Effects Board.

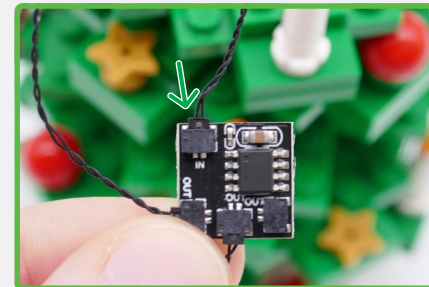

5cm Connecting Cable

NOTE

Take a 5cm Connecting Cable and connect it into the "IN" port of the Flicker Effects Board.

NOTE

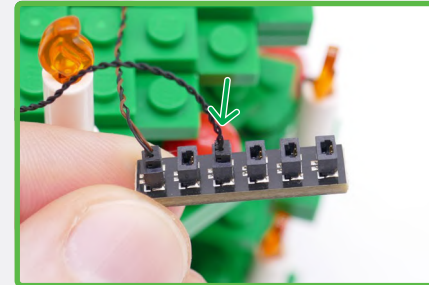
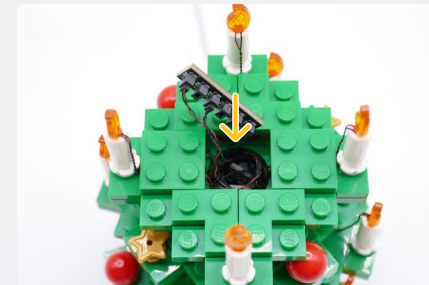
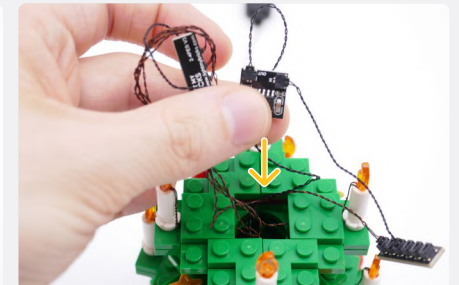
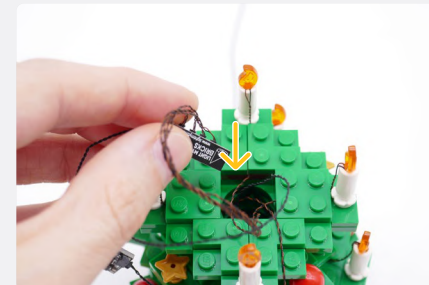
Connect the other end of the 5cm Connecting Cable into the 6-Port Expansion Board.

41

NOTE

Push in the 6-Port Expansion Board but do NOT force it. Check if there is enough space, if not push down the other boards more then try again.

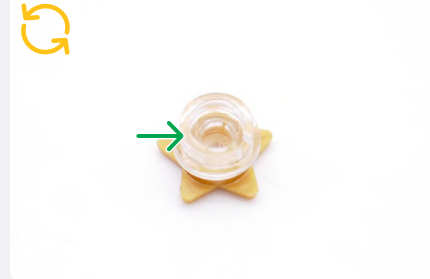
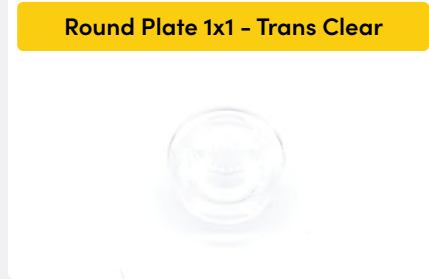

42



43



44

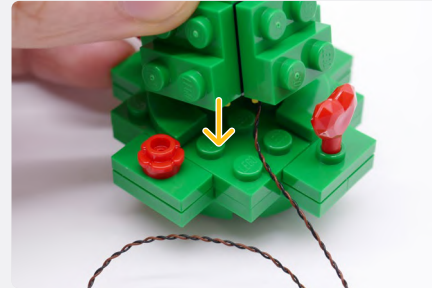
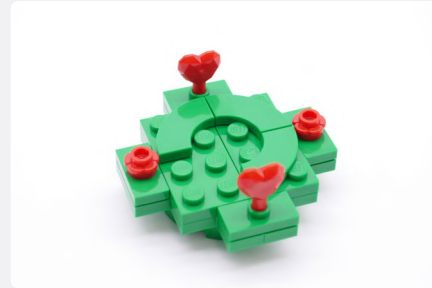
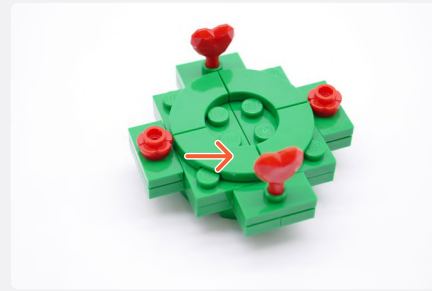
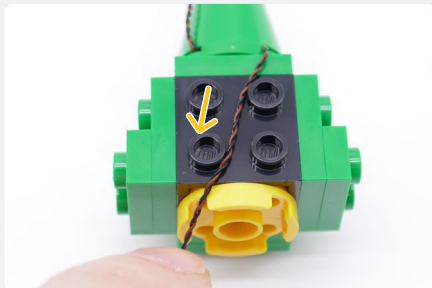

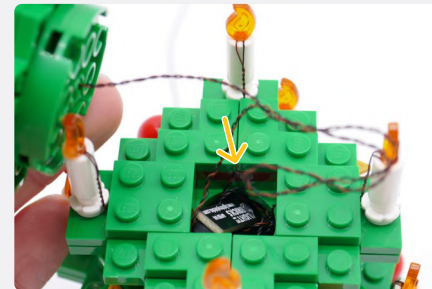
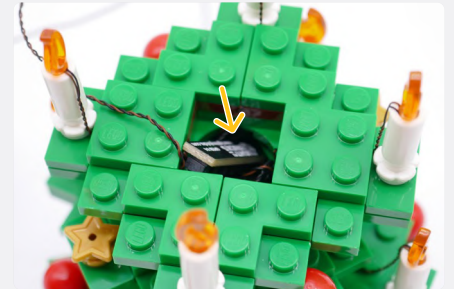
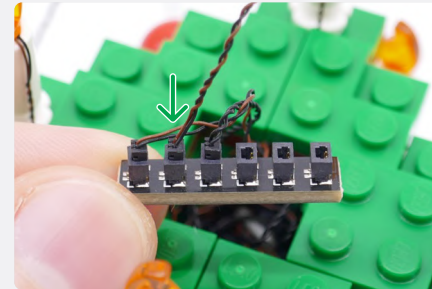
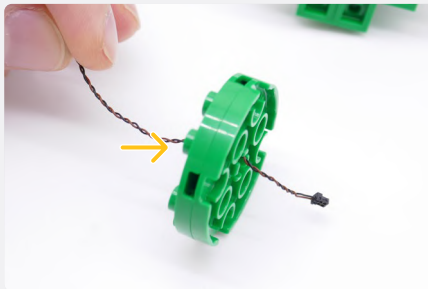
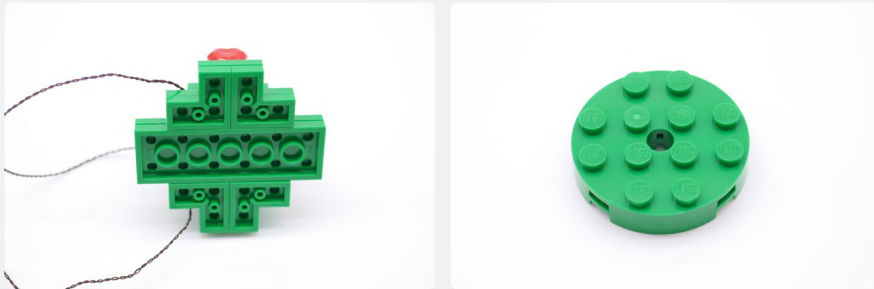

NOTE

Connect to a 5V USB Power Bank, 5V USB Wall Adaptor, or USB to AA Battery Pack (sold separately)





! If you experience any issues with the lights not working and suspect an issue with a component, please try a different port on the expansion board to verify where the fault lies (with the light or expansion board). To correct any issues with expansion board ports, please view the section addressing expansion board issues in our troubleshooting section. i

NOTE

You should have these parts left over that were removed from this LEGO set.



NOTE

You should have these pieces that were removed from both sets.



FINAL PRODUCT

This finally completes installation of the Light My Bricks

LEGO® Christmas Tree 2-In-1 40573 Light Kit.





TROUBLESHOOTING

Light My Bricks lighting kits contain individual components that are very small and can be easily damaged if not handled correctly.

To prevent unnecessary damage to components, we highly recommend that the User Guide section, **“Important things to note”** is read carefully. Follow the handling procedures in the User Guide to help prevent faults and damages to your Light My Bricks components.

If you are experiencing issues with your Light My Bricks set, watch our troubleshooting video or read on for a list of common causes to help you troubleshoot.



Wenn Sie Probleme mit Ihrem Light My Bricks-Set haben, sehen Sie sich unser Video zur Fehlerbehebung an oder lesen Sie die Auflistung der häufigsten Ursachen, die Ihnen bei der Fehlersuche helfen hier.



Si vous rencontrez des problèmes avec votre kit Light My Bricks, regardez notre vidéo de dépannage ou consultez la liste des causes les plus fréquentes pour vous aider à les résoudre ici.



Se si verificano problemi con il set Light My Bricks, guardare il nostro video per la risoluzione dei problemi o leggere l'elenco delle cause più comuni per la risoluzione dei problemi qui.

Troubleshooting

Firstly, ensure that the batteries have power using a battery charge gauge.

If the batteries have no power, replace the batteries.

If the batteries still have power, check to see if the batteries have been inserted correctly into the battery pack.

Check for AA batteries using the AA battery pack

Inside the battery pack are symbols indicating which direction the AA battery should be inserted. The flat side of the battery should be paired with the spring side of the battery pack.

If the batteries have been installed correctly and your kit still isn't operating correctly, the next step is to check the wiring.

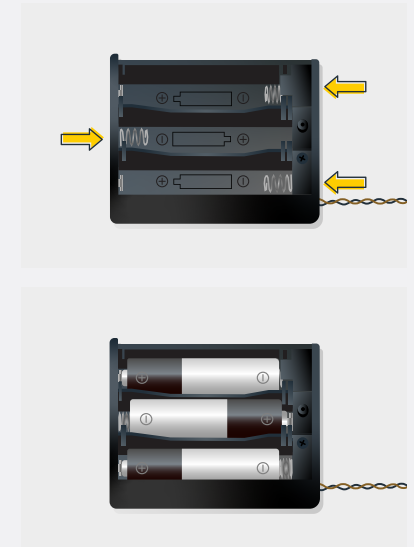

Troubleshooting

Check Your Wires

In order for Light My Bricks components to fit in between and underneath LEGO® bricks, the components need to be very small. Due to this nature, Light My Bricks components can be easily damaged when not handled correctly.

Be careful when removing unpacked components out of the packaging and ensure not to forcibly pull at the wires as this can damage the soldering that attach the wires to the LEDs.

If the wiring is detached from the LED itself, the light will not operate.

When connecting lights to your LEGO® set, check that there are no pinched wires underneath or in between bricks and plates.

When the wires are pinched and the exposed wires are touching each other, this can cause a crosswire and the lights to not function correctly.

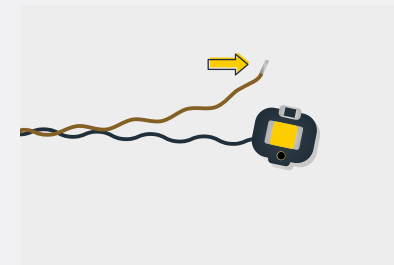
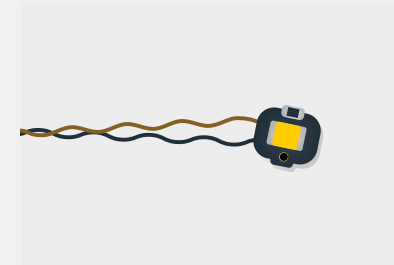

Troubleshooting

Check Your Expansion Board Ports/ Strip Light Ports / Effects Board Ports

It is important to note that connectors can only be inserted to the expansion board, strip light, or effects board ports in one direction.

Forcibly inserting connectors in the incorrect direction will result in damaging the pins inside each of the ports on your component board.

Not only will a light connected to the damaged port not work, but if the pins inside the port are bent to a point they are touching each other, this can result in all other lights in the system to stop working. This is a short circuit.

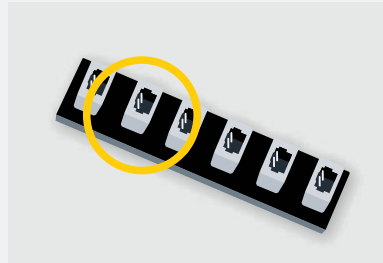

A short circuit can also result in overheating of the board, cable or batteries. If you suspect a short circuit, **DISCONNECT POWER IMMEDIATELY**. Batteries can fail, catch fire, or even explode if left connected to a short circuit for too long.

If you suspect you have a faulty component due to a bent pin, try the following steps:

If you look carefully inside each of the ports, each port contains 2 small pins that should be straight. You will be able to identify a faulty port if it has any bent pins.

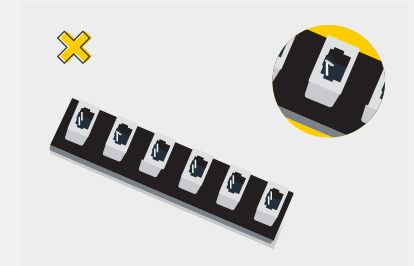
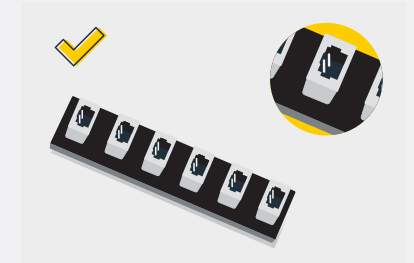
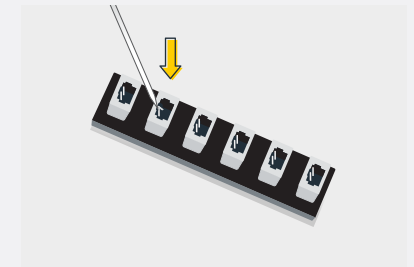



CONTACT US

If you have an enquiry regarding the online shop, our products or a general enquiry please refer to our Frequently Asked Questions webpage.

Alternatively, you can contact our Customer Services team by visiting our online support portal.

support.lightmybricks.com

We thank you for purchasing this product and hope you enjoy!



lightmybricks.com