



**LIGHT^{MY}
BRICKS**



LEGO[®] DISNEY CASTLE #43222

LIGHT KIT

INSTALLATION GUIDE

Light My Bricks



LEGO® DISNEY CASTLE 43222 INSTALLATION GUIDE

Hi There!

We're here to help you get started on the LEGO®

Disney Castle 43222 Light Kit.

This PDF details the instructions for the LED light kit only.

If you run into any issues, please refer to the troubleshooting section towards the end of this guide.

Have fun and enjoy!

INSTALLATION GUIDE





PACKAGE CONTENTS:

Individual Bags



- 12 x White 30cm Bit Light *
- 17 x Warm White 30cm Micro Bit Light *
- 1 x Yellow 15cm Bit Light
- 3 x Yellow 30cm Bit Light
- 4 x Cool White 30cm Bit Light
- 12 x White 15cm Bit Light
- 1 x Green 30cm Bit Light
- 1 x Pink 30cm Bit Light
- 3 x Warm White 15cm Micro Bit Light
- 1 x Blue 15cm Micro Bit Light
- 1 x Warm White 30cm Headlight
- 2 x Wireless Power Connectors (Pairs)

USB Power Cable



2x USB Power Cable
(Power Source not Included)

Connecting Cables



- 6 x 5cm Connecting Cable
- 4 x 15cm Connecting Cable
- 4 x 30cm Connecting Cable *
- 2 x 50cm Connecting Cable

Mixed Components 1



- 2 x 6-Port Expansion Board
- 3 x 8-Port Expansion Board
- 2 x 12-Port Expansion Board
- 4 x 2-Port Expansion Boards
- 10 x Adhesive Squares*

Mixed Components 2



- 2 x 4-Port Micro Expansion Board
- 2 x 8-Port Micro Expansion Board
- 2 x Flicker Effects Board

* Indicates components which include spares



PACKAGE CONTENTS:

Mixed Components 3



- 1 x Brick 1x4 - Light Bluish Gray
- 1 x Brick 1x2 without Bottom Tube - Trans-Clear
- 2 x Brick, Modified 1x1 with Stud on Side - Light Bluish Gray

Mixed Components 4



- 6 x Tile, Modified 1x1 with Open O Clip - Black
- 1 x Slope 30 1x1 x 2/3 - Trans-Clear
- 1 x Brick, Round 1x1 Open Stud - Black
- 1 x Brick, Round 1x1 Open Stud - Trans-Clear

Mixed Components 5



- 13 x Plate, Round 1x1 with Open Stud - Black
- 6 x Plate, Round 1x1 with Open Stud - White
- 1 x Plate, Round 1x1 with Open Stud - Pearl Gold
- 2 x Plate, Round 1x1 - Trans-Light Blue
- 1 x Tile, Round 1x1 - Trans-Clear

Mixed Components 6



- 9 x Plate, Round 2x2 with Rounded Bottom (Boat Stud) - Trans-Clear

Mixed Components 7



- 7 x Plate 1x2 - Light Bluish Gray
- 4 x Plate, Round 1x1 with Bar Handle - Black
- 2 x Plate, Modified 1x2 with Bar Handle on Side Closed Ends - Black
- 1 x Plate 1x2 - Trans-Clear

Mixed Components 8



- 4 x Plate 1x6 - Black
- 1 x Plate 1x6 - Light Bluish Gray
- 1 x Plate 2x4 - Black

RGB Components



- 2 x RGB 15cm Connecting Cable
- 2 x RGB IR Control Board
- 1 x RGB Remote Control
- 2x RGB Strip Light 2.0
- 2x RGB String Light 50cm

Contents

Before You Begin	6
Blueprint	11
Instructions Lower	13
Instructions Upper	62
Final Product	108
Troubleshooting	109
Contact	113

Before You Begin

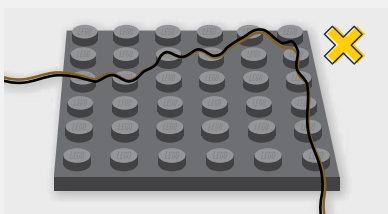
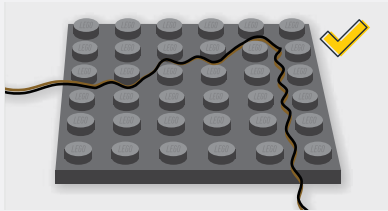

Laying cables in between and underneath bricks

Cables can fit in between and underneath LEGO® bricks, plates, and tiles providing they are laid correctly between the LEGO® studs. Do NOT forcefully join LEGO® together around cables; instead ensure they are laying comfortably in between each stud.

CAUTION: Forcing LEGO® to connect over a cable can result in damaging the cable and light.

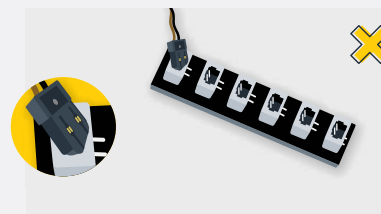
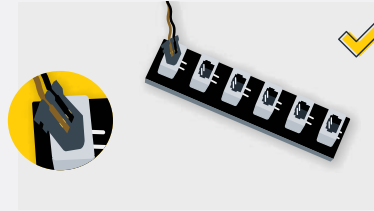

Connecting Cable Connectors To Expansion Boards

Take extra care when inserting connectors to ports of Expansion Boards. Connectors can be inserted only one way. With the expansion board facing up, look for the soldered "=" symbol on the left side of the port. The connector side with the wires exposed should be facing toward the soldered "=" symbol as you insert into the port. If a plug won't fit easily into a port connector, do not force it.

Incorrectly inserting the connector can result in bent pins inside the port or possible overheating of the expansion board when connected.

Before You Begin

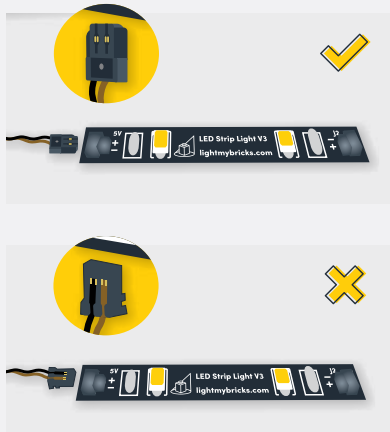

Connecting Cable Connectors To Strip Lights

Take extra care when inserting connectors to ports on the Strip Lights. Connectors can be inserted only one way. With the Strip Light facing up, ensure the side of the connector with the wires exposed is facing down. If a plug won't fit easily into a port connector, don't force it. Doing so will damage the plug and the connector.



Connecting Micro Cable Connectors To Micro Expansion Board Ports

Take extra care when inserting the micro connectors to micro ports of Micro Expansion Boards. Connecting Micro Bit Lights to Micro Expansion Boards is similar to connecting lights and cables to Strip Lights. With the expansion board facing up, ensure the side of the connector with the wires exposed is facing down. If a plug won't fit easily into a port connector, do not force it. Use your fingernail to push the plastic part of the connector to the micro port.

Before You Begin

Installing Bit Lights Under Lego® Bricks And Plates

When installing Bit Lights under LEGO® pieces, ensure they are placed the correct way up (Yellow LED component exposed). You can either place them directly on top of LEGO® studs or in between.

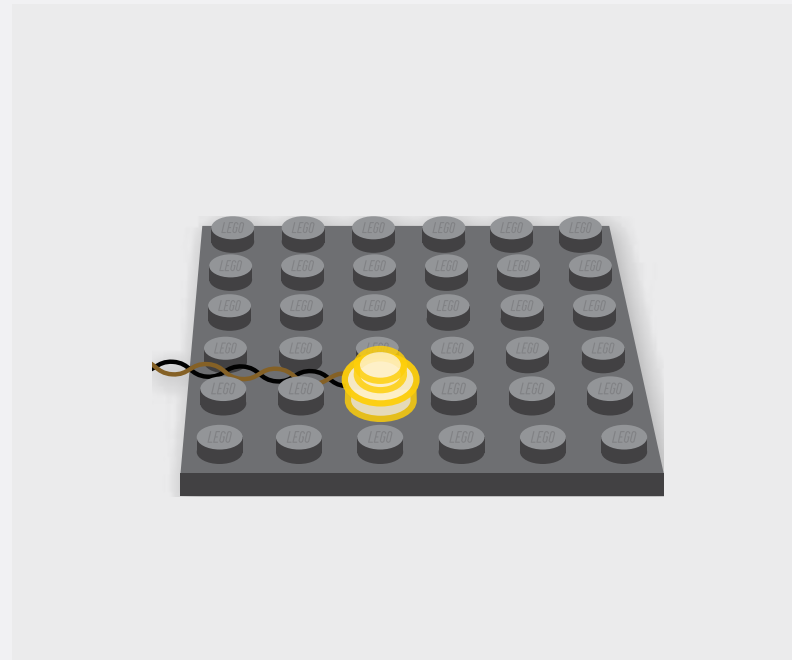

Before You Begin

The Symbols Used In This Guide

When going through the following guide you will come across symbols and formats that will assist with the installation of your light kit. Take notice of them as each has a specific purpose.

Light Kit Component

This is the most important image format as it indicates which part to use from the Light Kit. Make sure you pay close attention to which part is shown.



Connect

Used when you need to connect a LEGO piece or LMB component.



Disconnect

Used when you need to remove a LEGO piece/ section or LMB component.



Directional

Used to show where to route cables, place components, or move them.



Bend/Pivot

Used when a component needs to be bent, or part folded or pivoted.



Turn/ Flip

Will be found in the top left corner when the set needs to be rotated or flipped.



Twist/ Braid

Seen when a set of cables need to be grouped and twisted together.



Power On Test

Found at the end of a major step to test the lights. Will be located in the top left corner.



Note

Notes will be found alongside the instruction photos and explain what to do.



Before You Begin

Repeat Step

Repeat the previous step eg. Make a spotlight, then make a second spotlight.



Connect Focus

Used to highlight a hard to see area where a component is being connected.



Disconnect Focus

Used to highlight a hard to see area where a component is being disconnected.



General Focus

Used to highlight a hard to see area where a component needs to be acted on.



General Note

This is a sample note that is used anywhere in this guide. It will explain a difficult section where photos are hard to illustrate or easily confused.

Connect Note

The green coloured note is used when the topic focuses on a component being connected, like the shown Power Bank.

Disconnect Note

The red coloured note is used when the topic focuses on a component being disconnected or like here, the removed pieces.

NOTE

Take the 5cm Connecting Cable from the 4-Port Micro Expansion Board and route it into the "IN" port of the Flicker Effects Board

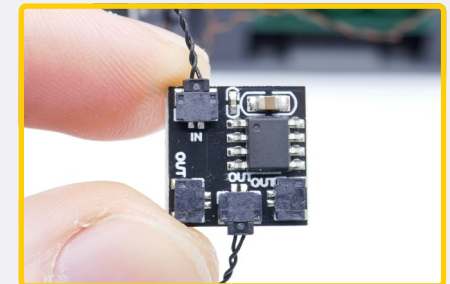

NOTE

Connect to a 5V USB Power Bank, 5V USB Wall Adaptor, or USB to AA Battery Pack (sold separately)



NOTE

You should have these parts left over that were removed from the LEGO set

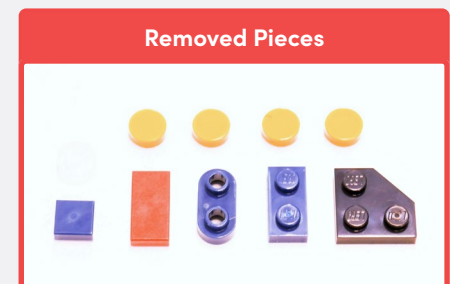



BLUEPRINT

Upper Section of Castle

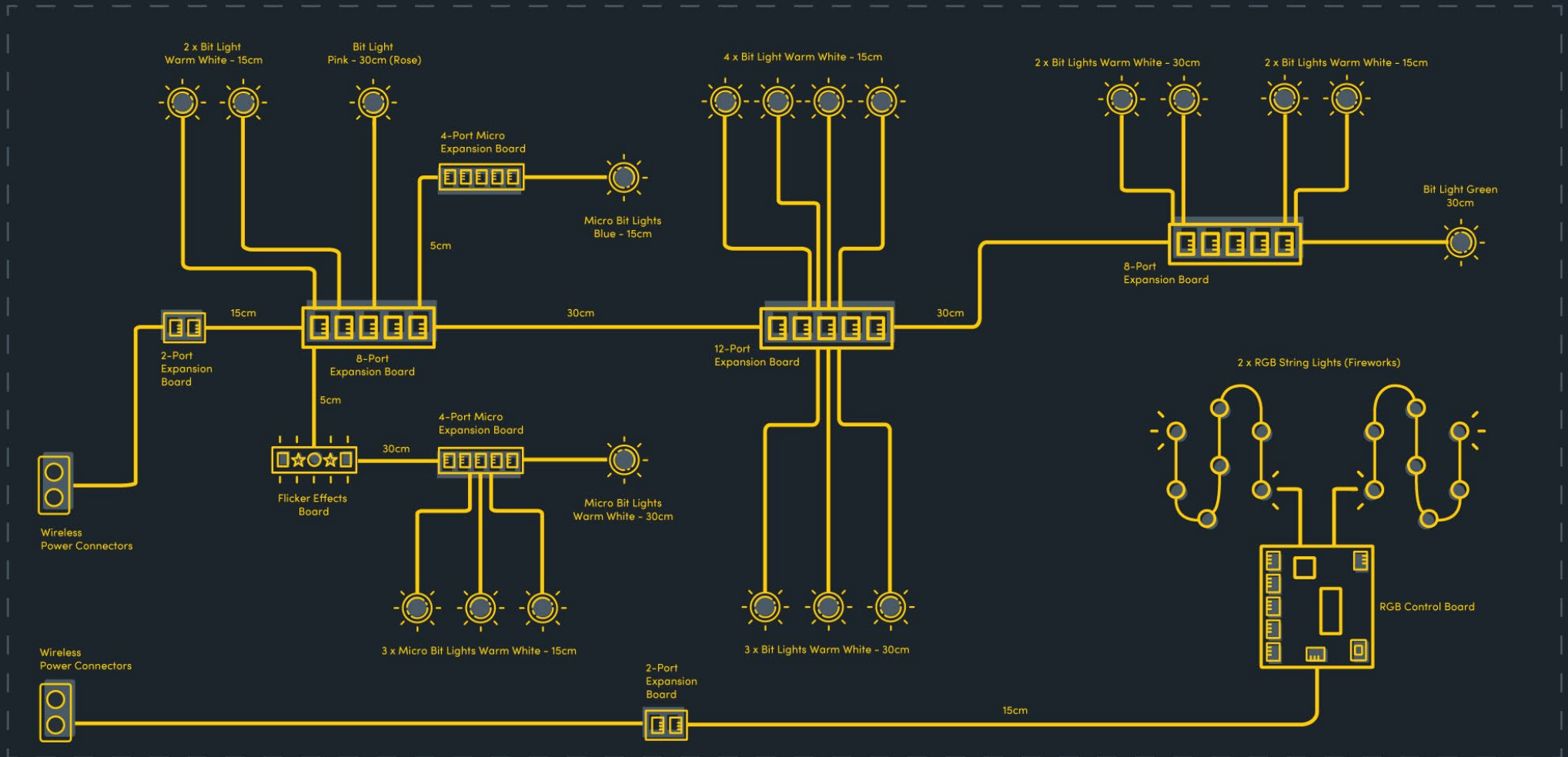



BLUEPRINT

Lower Section of Castle

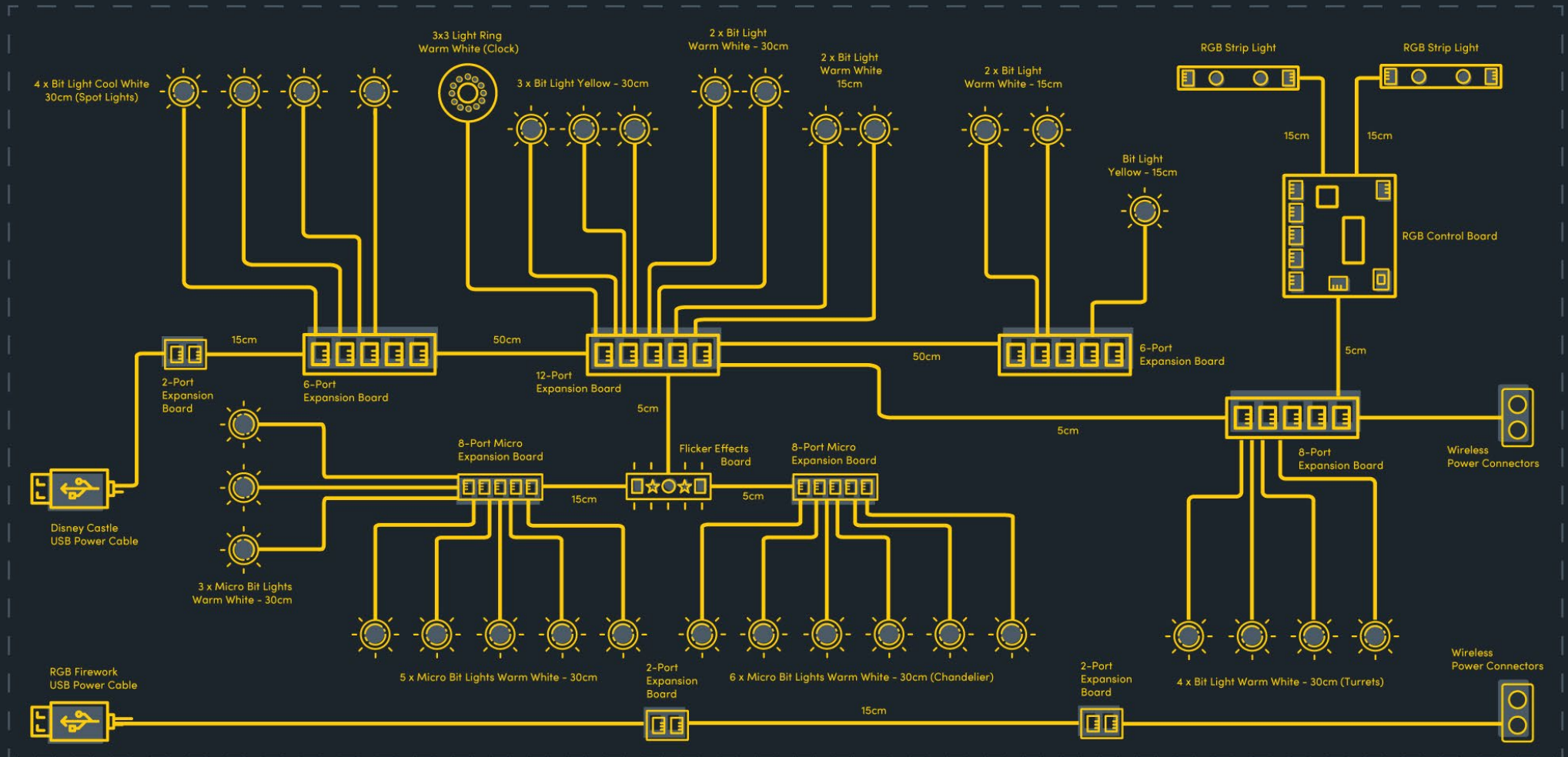



INSTRUCTIONS

To ensure a smooth installation of your light kit, please read and follow each step carefully. If you run into any issues, please refer to the online troubleshooting guide.



Wenn Sie Probleme mit Ihrem Light My Bricks-Set haben, sehen Sie sich unser Video zur Fehlerbehebung an oder lesen Sie die Auflistung der häufigsten Ursachen, die Ihnen bei der Fehlersuche helfen hier.



Si vous rencontrez des problèmes avec votre kit Light My Bricks, regardez notre vidéo de dépannage ou consultez la liste des causes les plus fréquentes pour vous aider à les résoudre ici.



Se si verificano problemi con il set Light My Bricks, guardare il nostro video per la risoluzione dei problemi o leggere l'elenco delle cause più comuni per la risoluzione dei problemi qui.

1

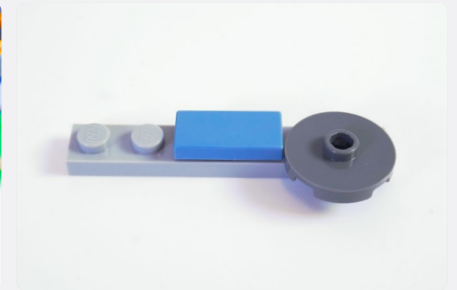
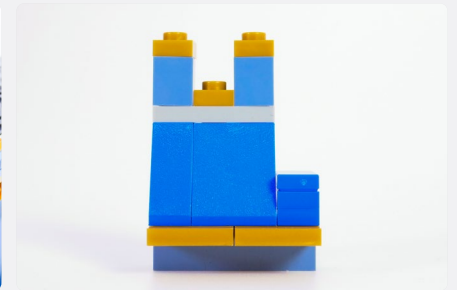
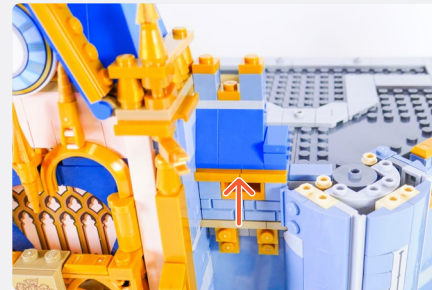

2

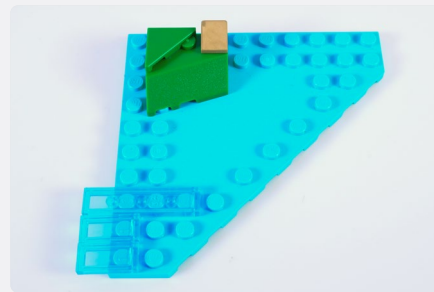
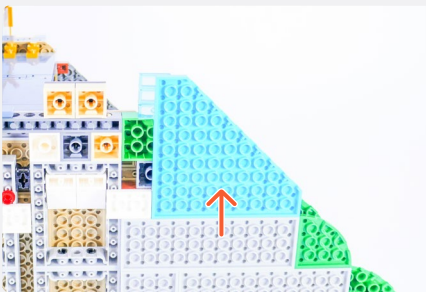
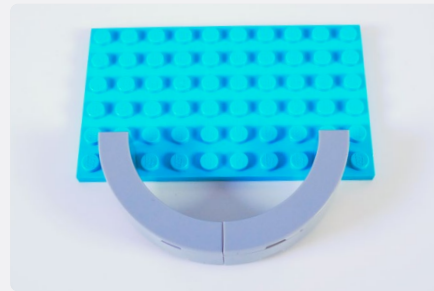
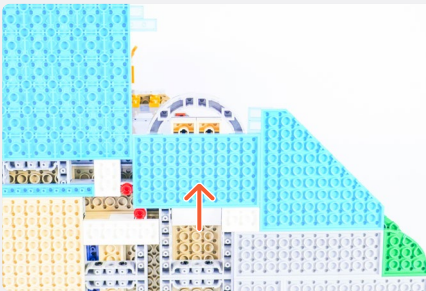
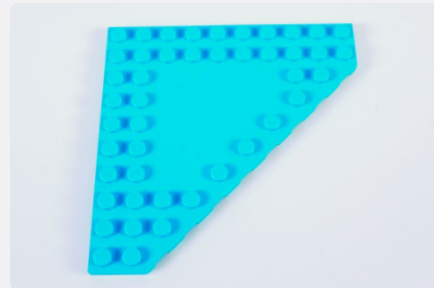
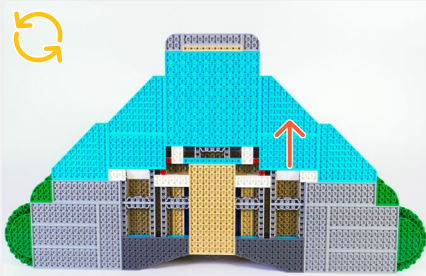

Plate, Round 1x1 with Open Stud - Black

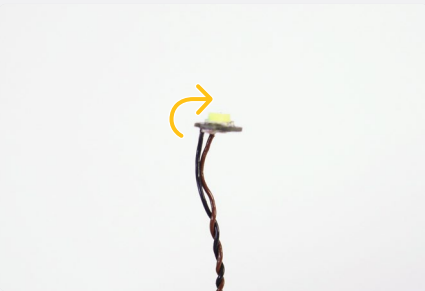

Plate, Round 1x1 with Bar Handle - Black

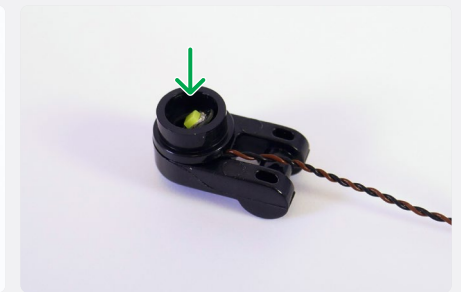

Tile, Modified 1x1 with Open O Clip
- Black



3

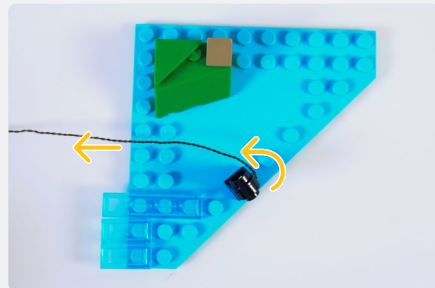
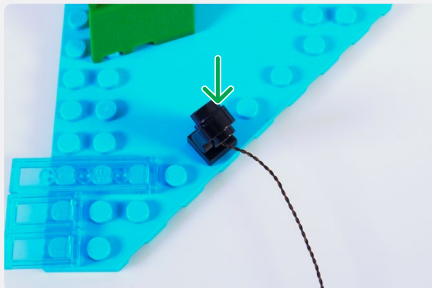
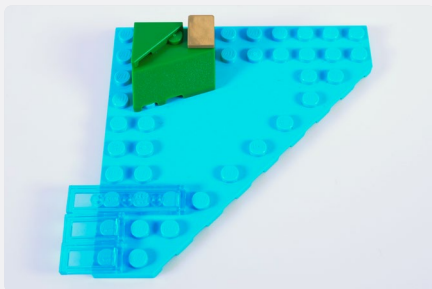

4

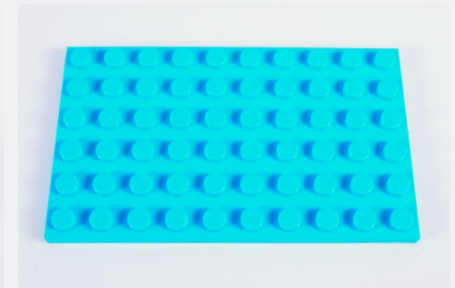
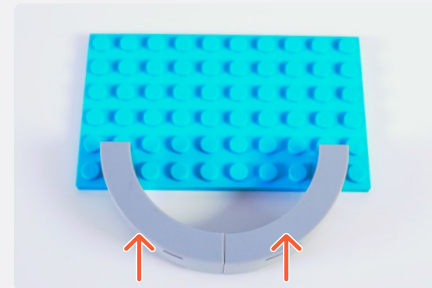
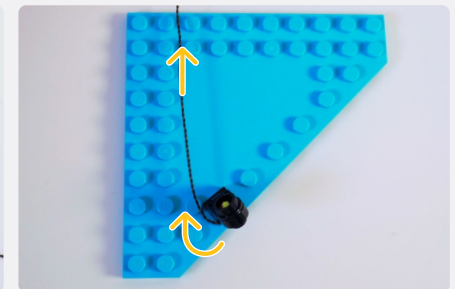
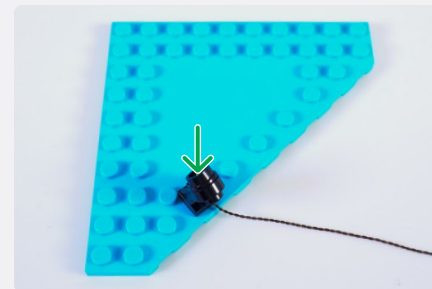
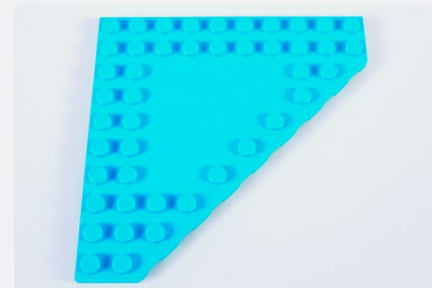

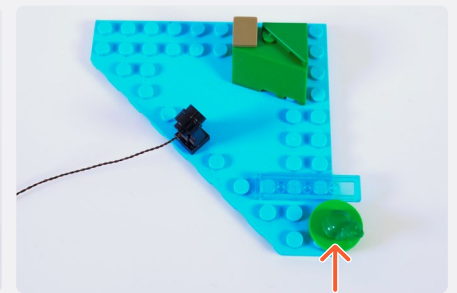
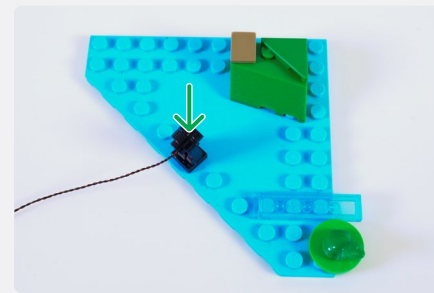
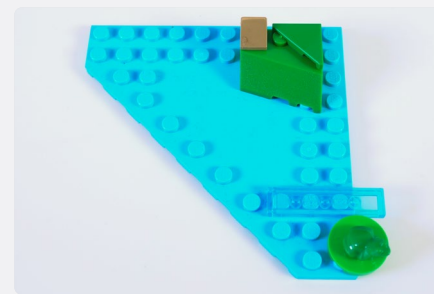
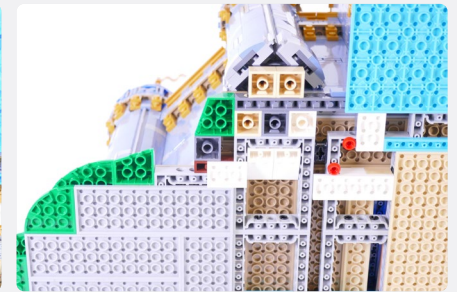
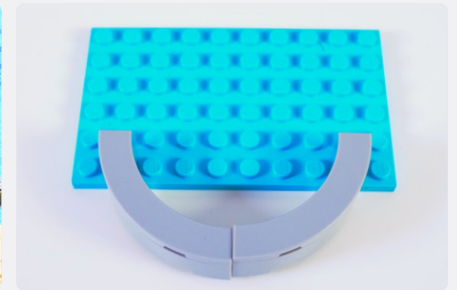
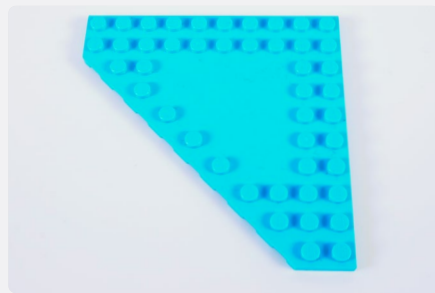
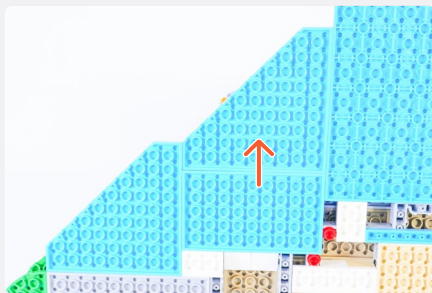
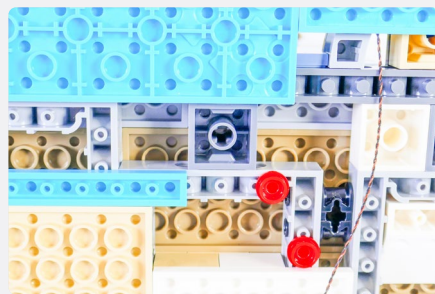
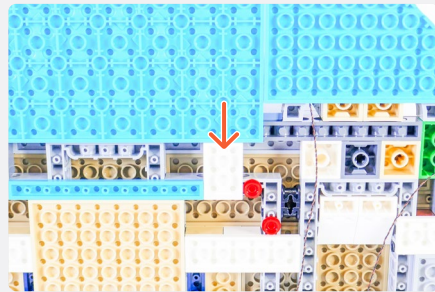
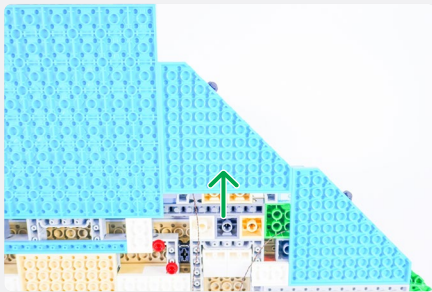
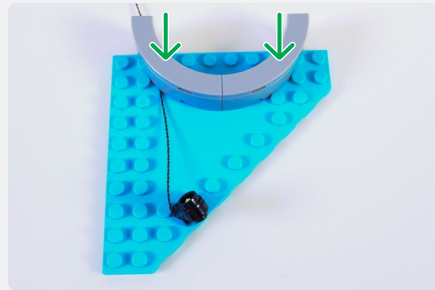

5

6

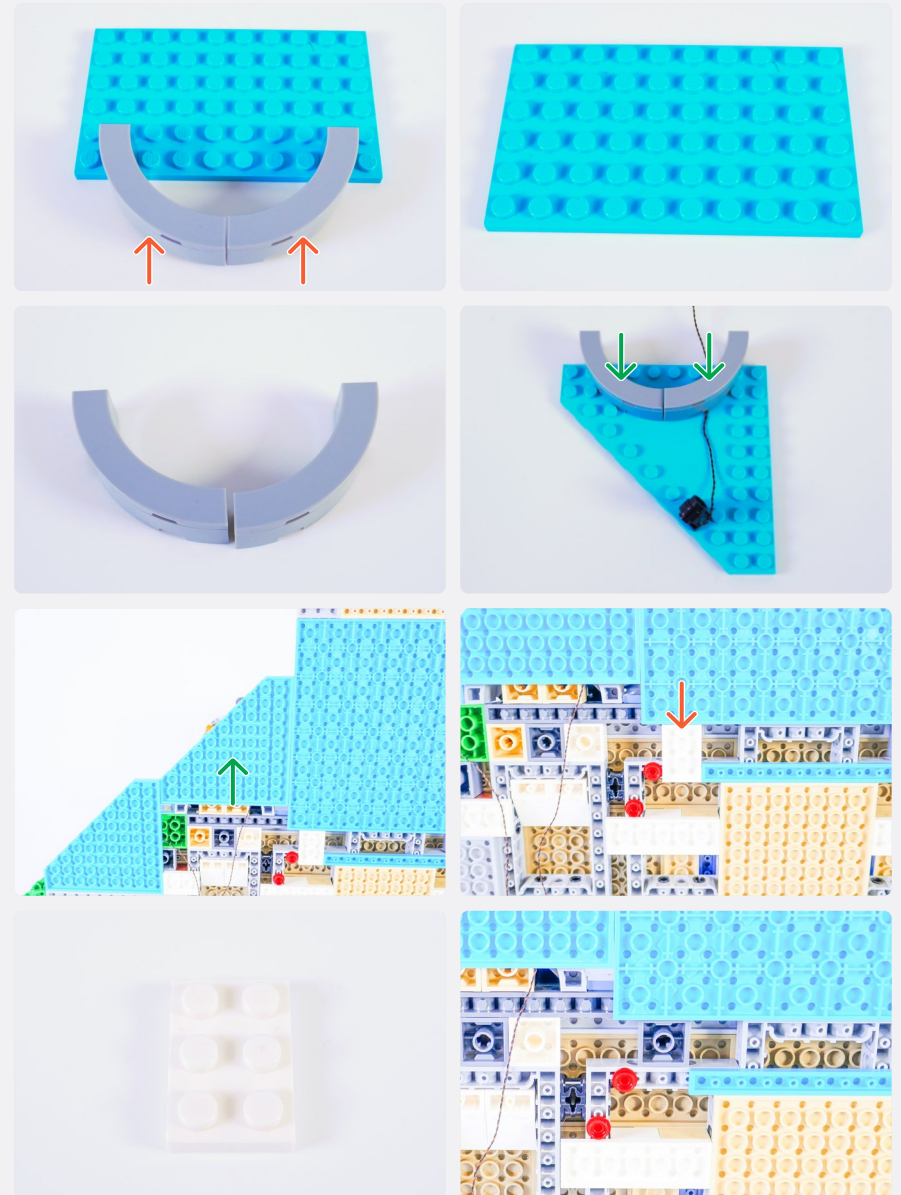
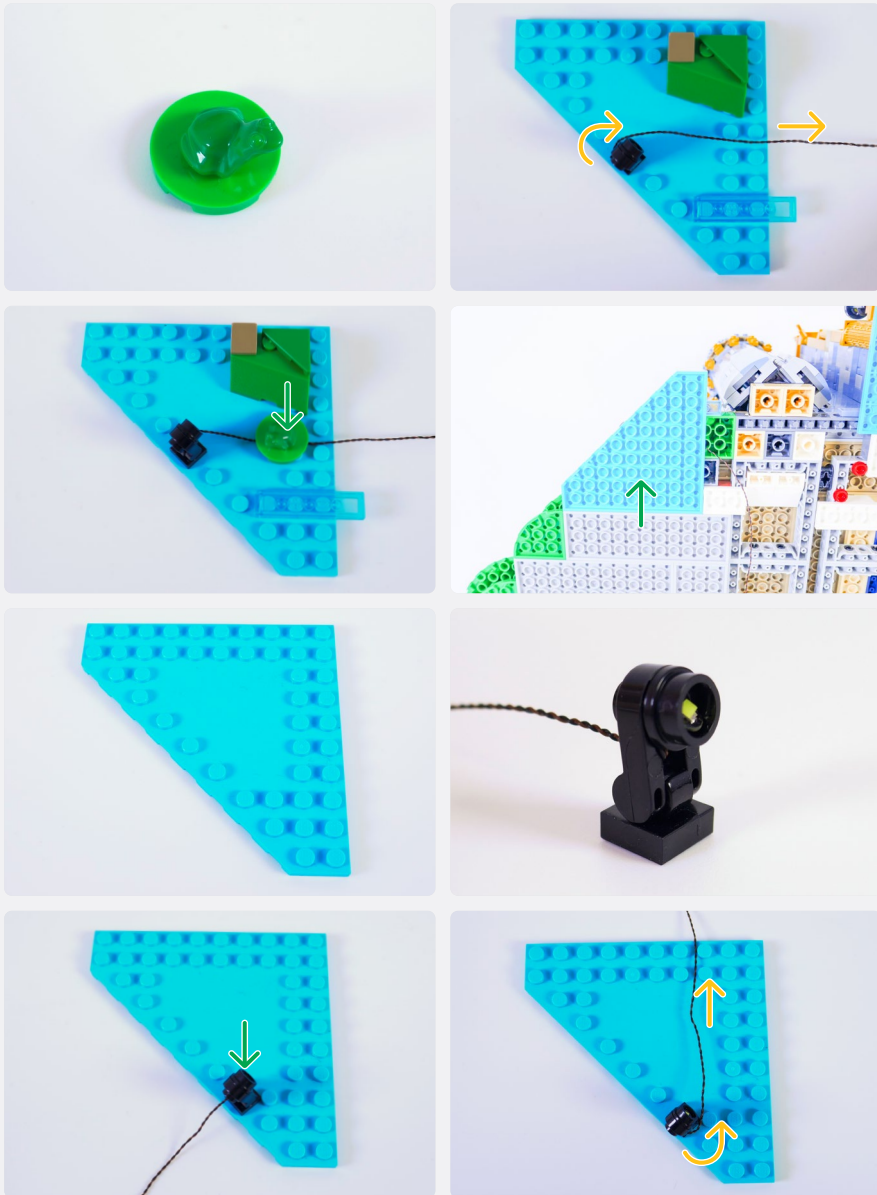

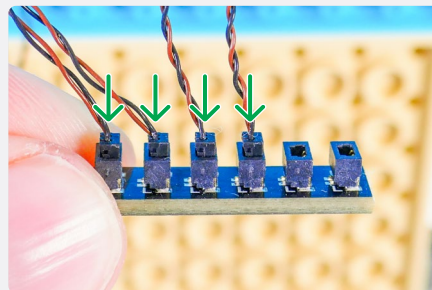
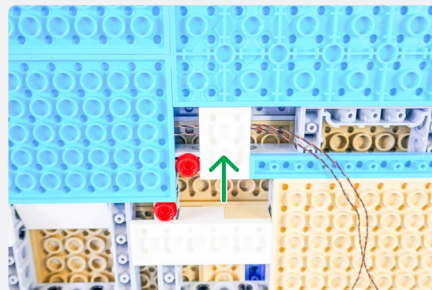
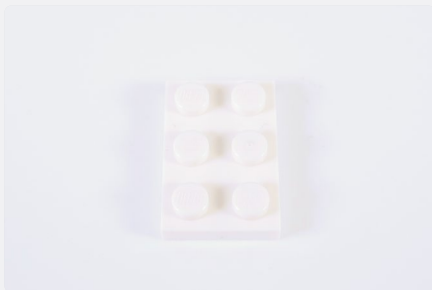
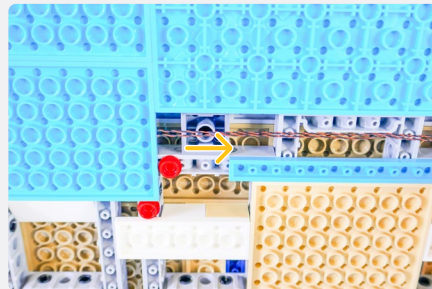
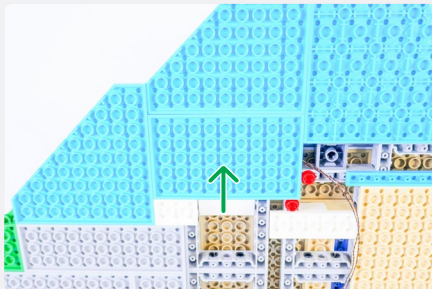
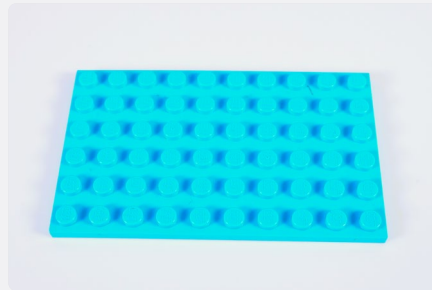
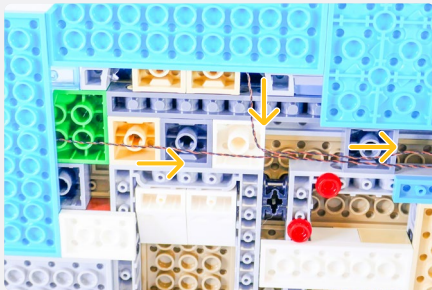

7

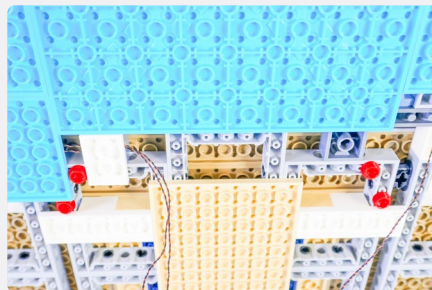
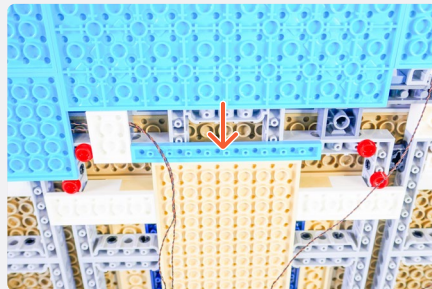
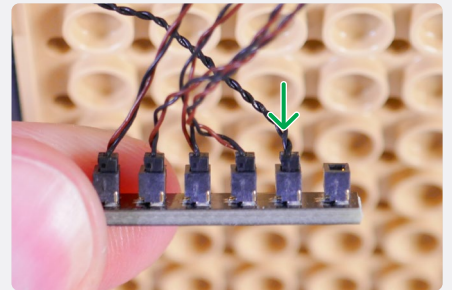

NOTE

Thread only the 15cm Connecting Cable down the side of the Tan Plate.

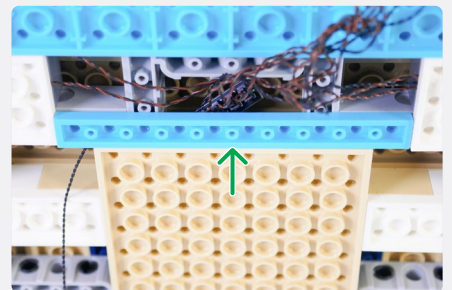
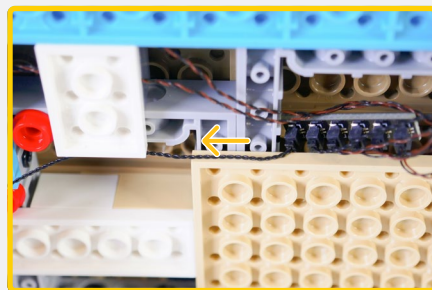

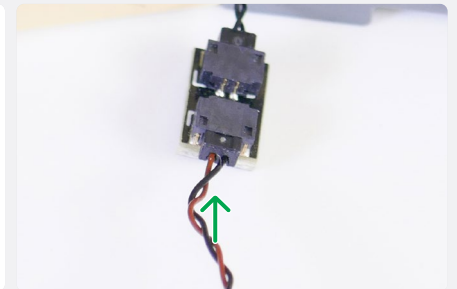
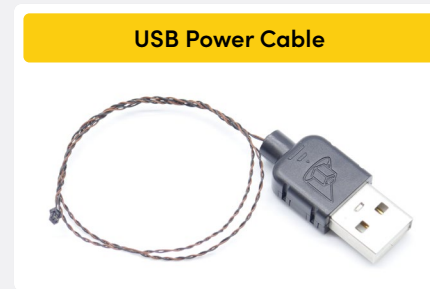
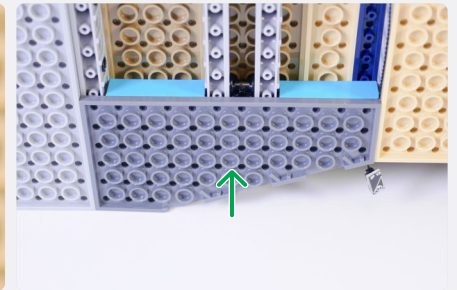
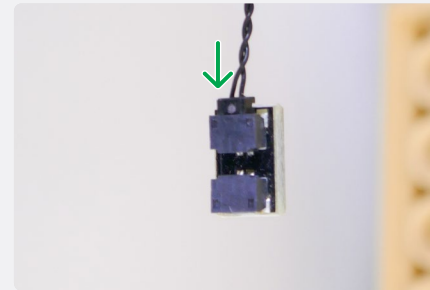
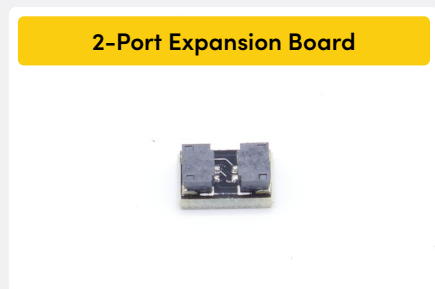
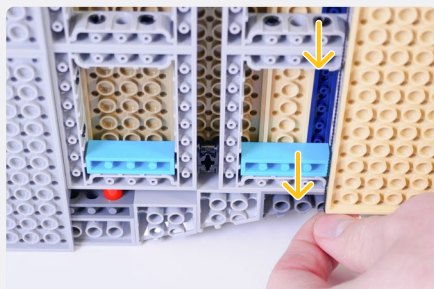
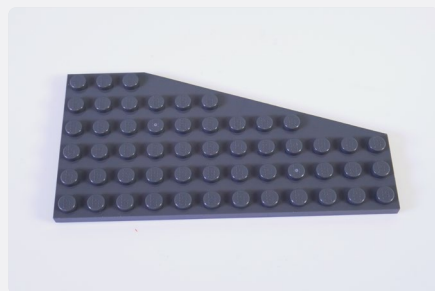
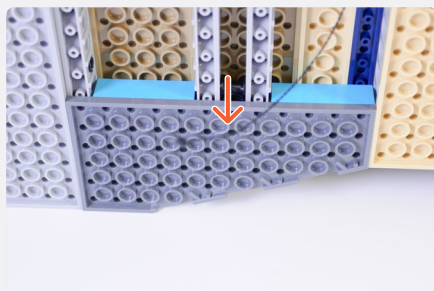
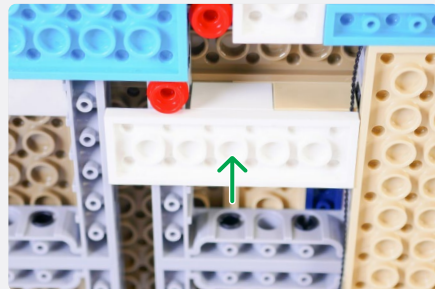
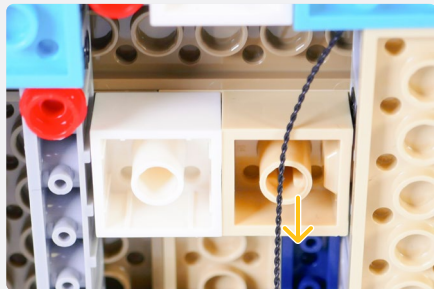
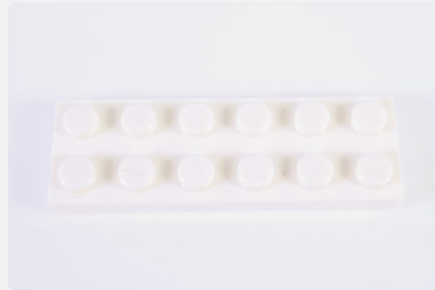
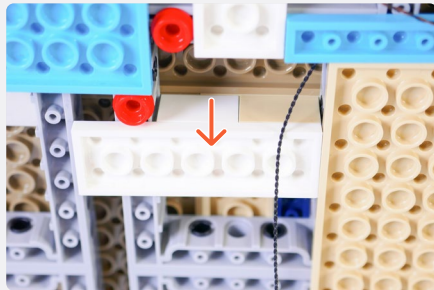

NOTE

Connect to a 5V USB Power Bank, 5V USB Wall Adaptor, or USB to AA Battery Pack (sold separately)

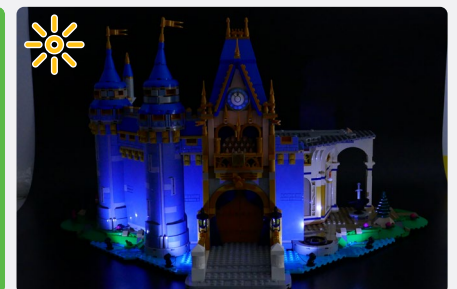



! If you experience any issues with the lights not working and suspect an issue with a component, please try a different port on the expansion board to verify where the fault lies (with the light or expansion board). To correct any issues with expansion board ports, please view the section addressing expansion board issues in our troubleshooting section. i

8

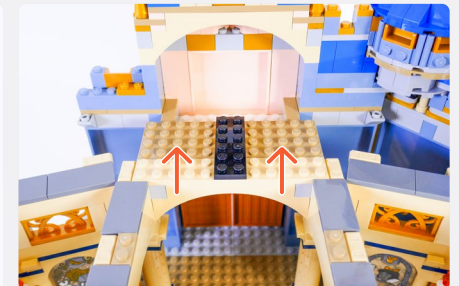
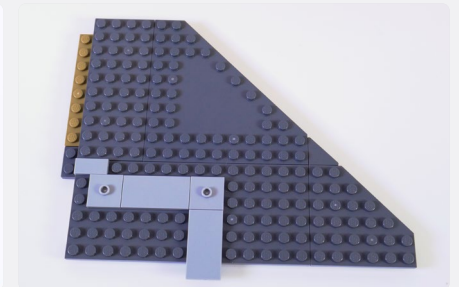
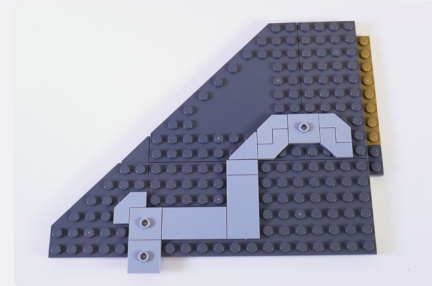
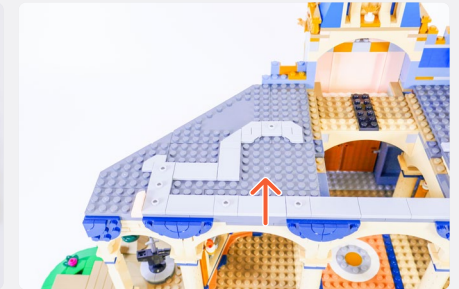
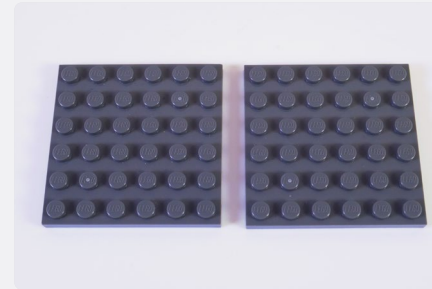
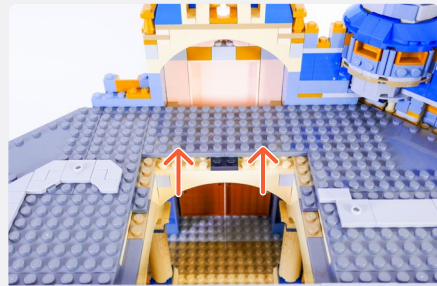
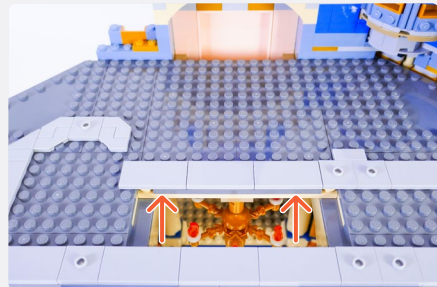
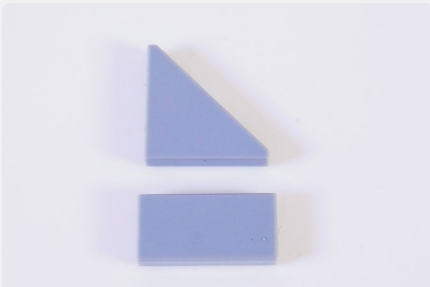
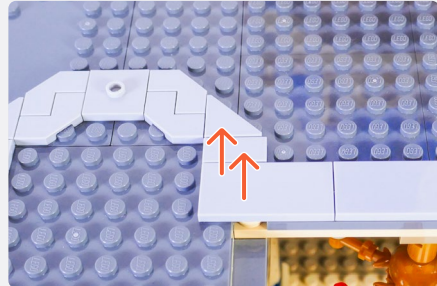

9

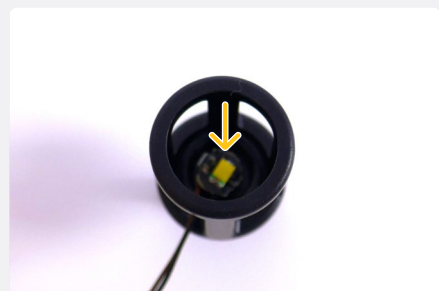
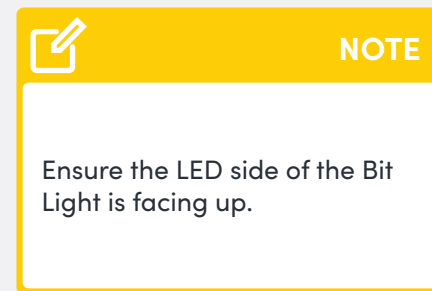
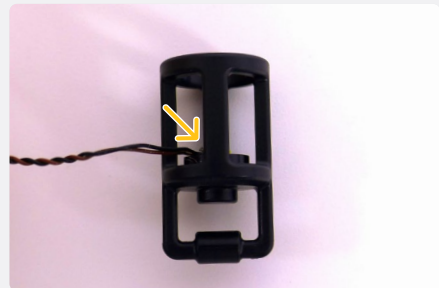
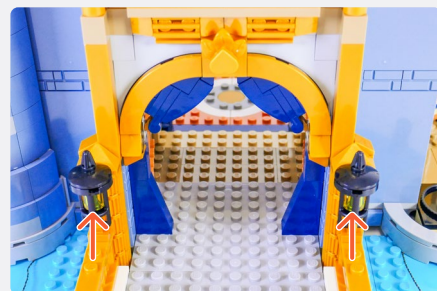
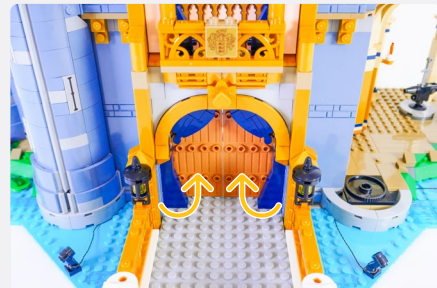
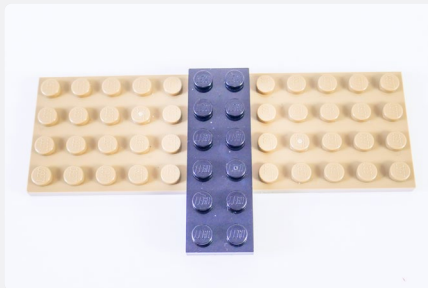

10

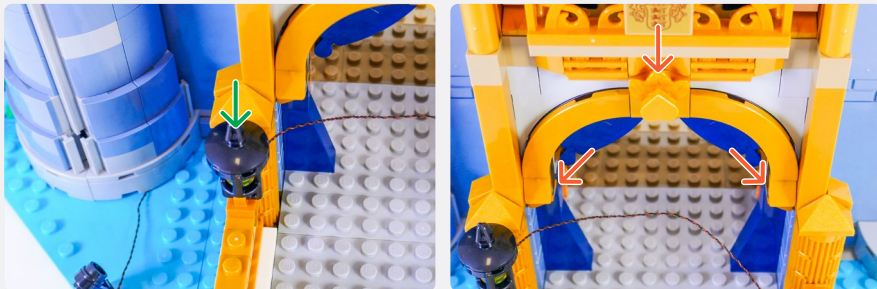
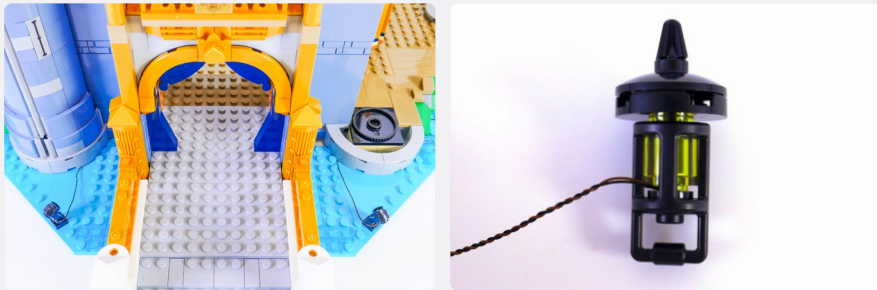

11

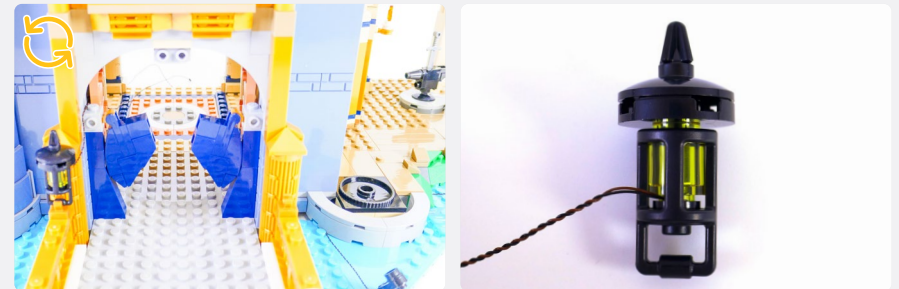
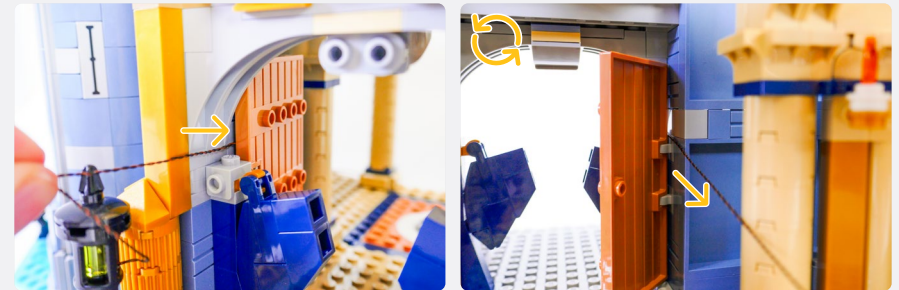

12

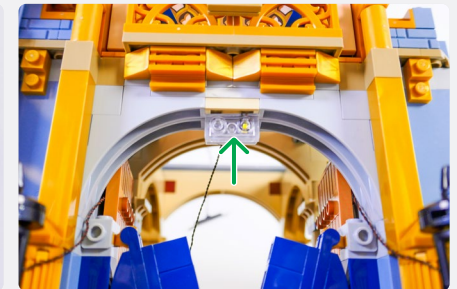
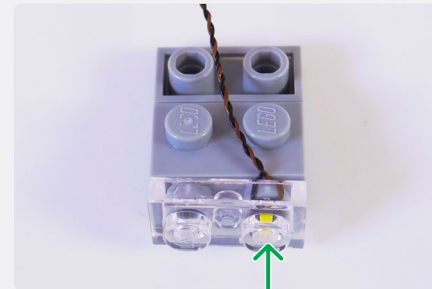
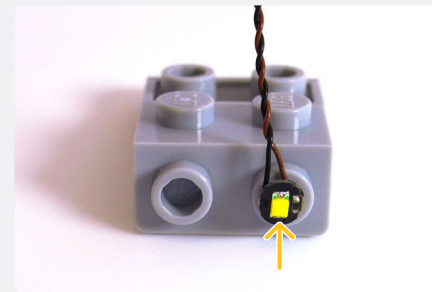
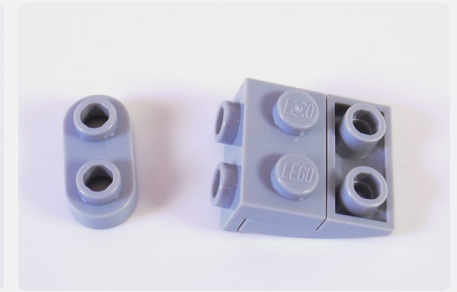
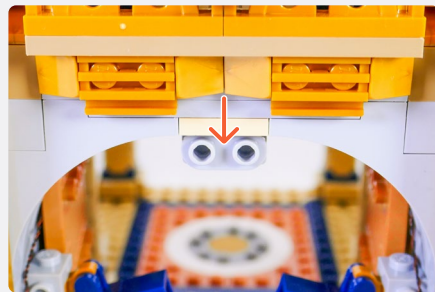
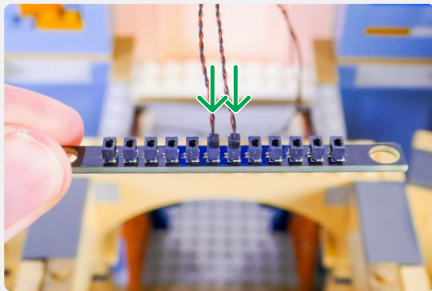
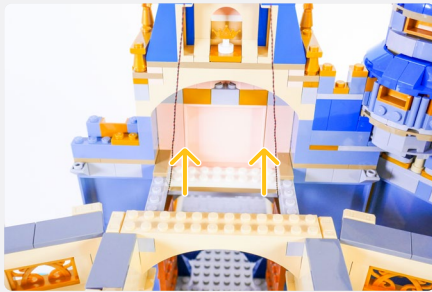

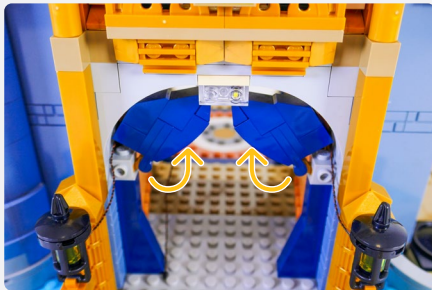

13

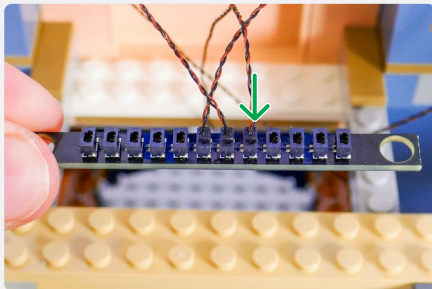
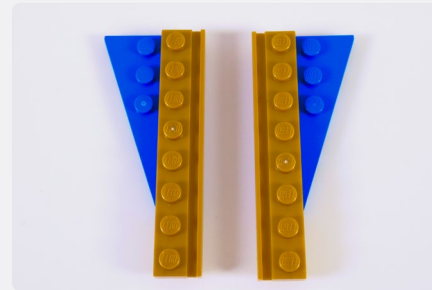
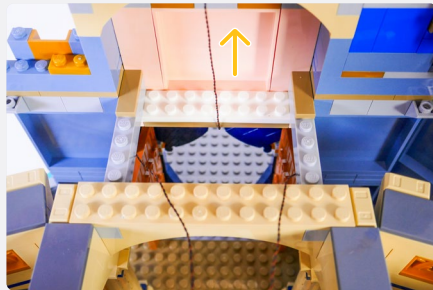
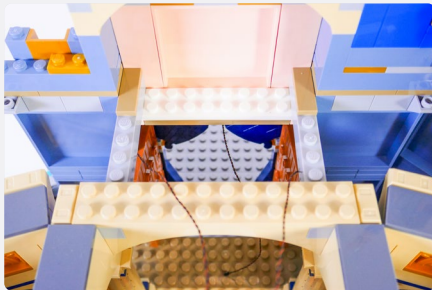
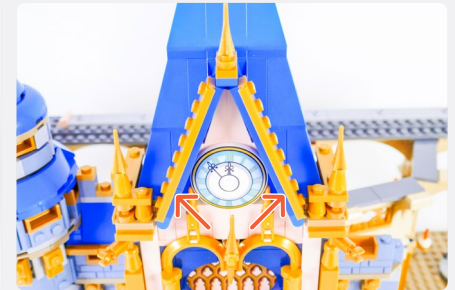

14

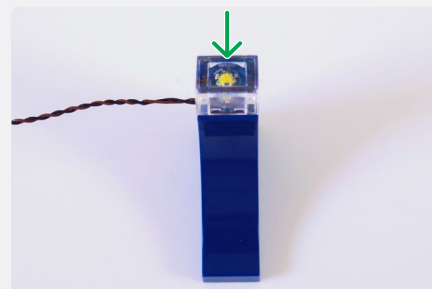
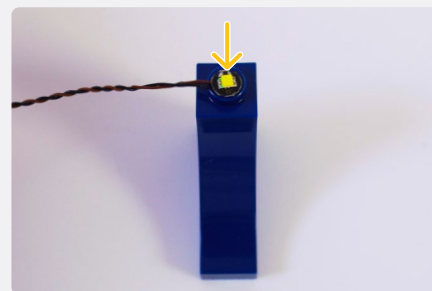
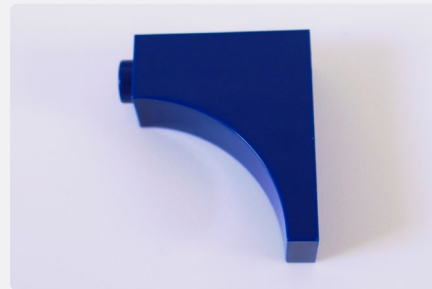
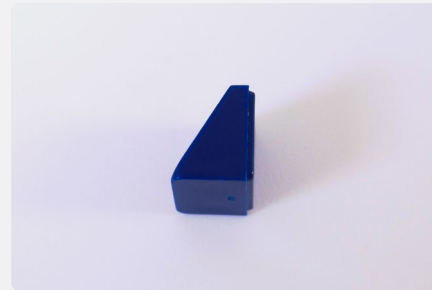
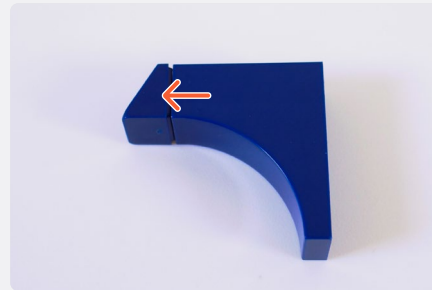
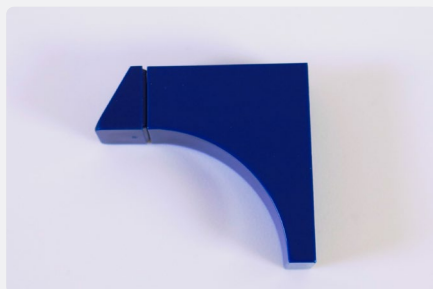
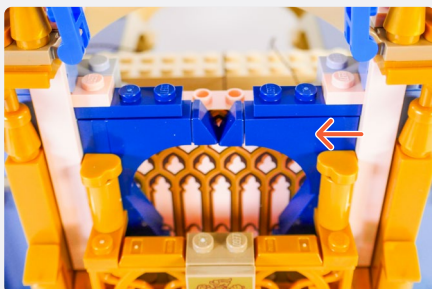
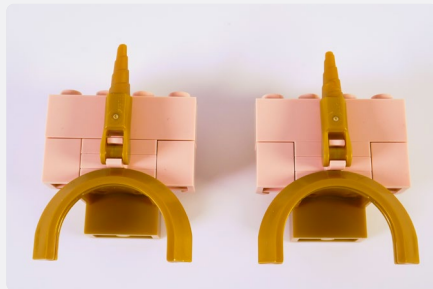
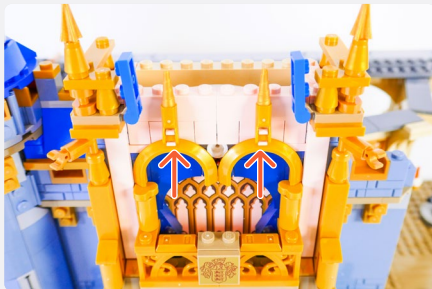
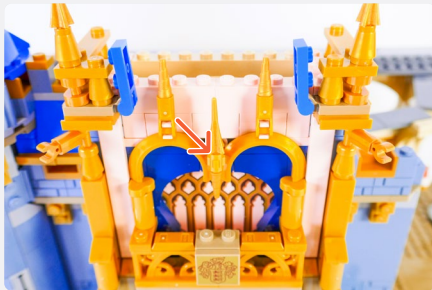

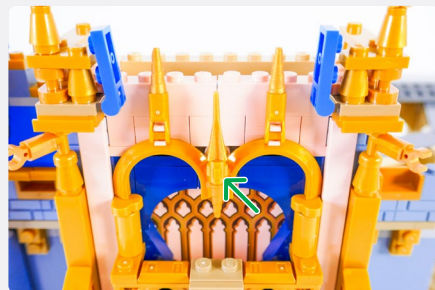
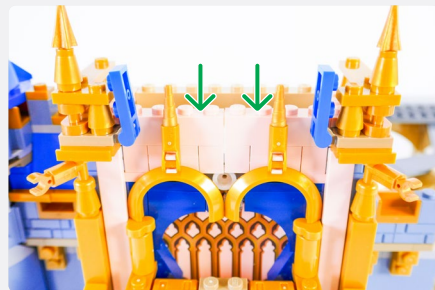
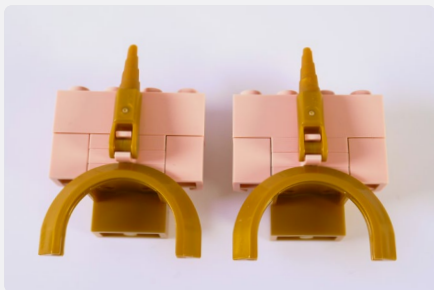
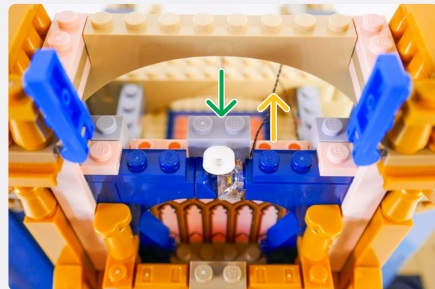
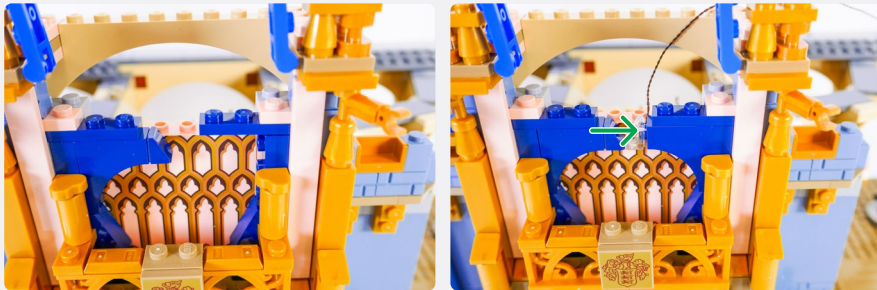

15

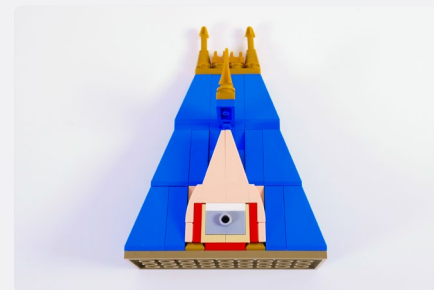
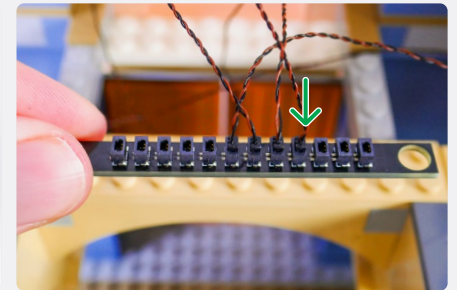

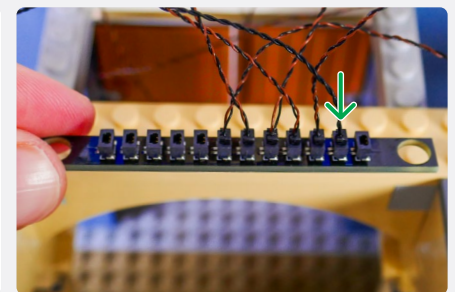
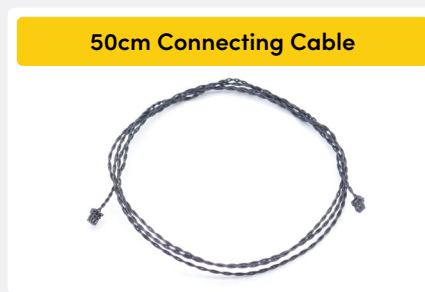
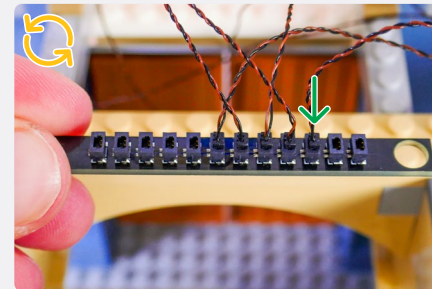
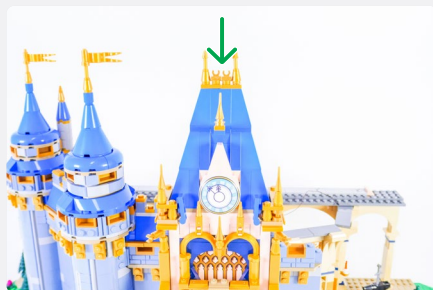
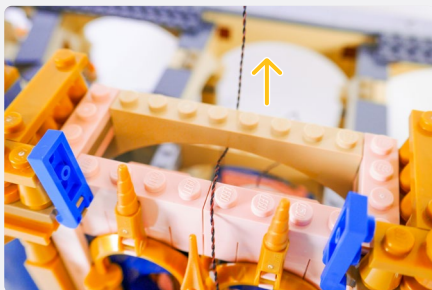
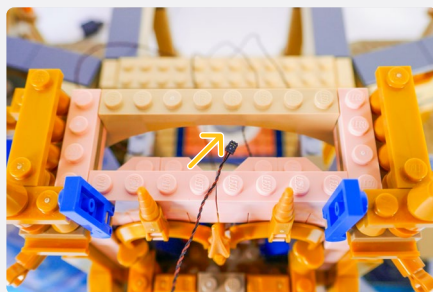
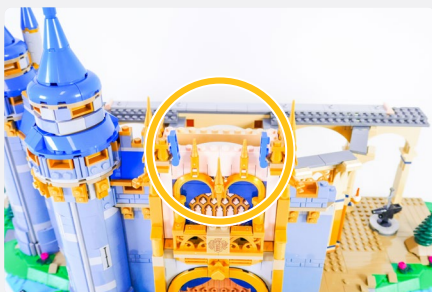
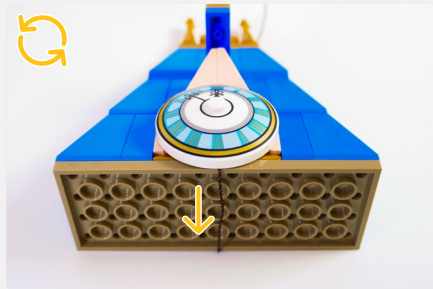
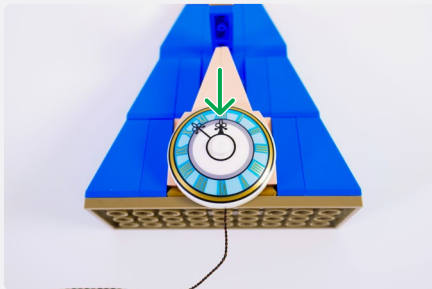
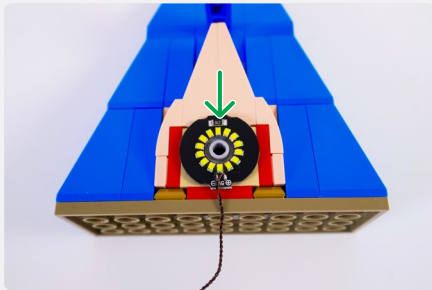

16

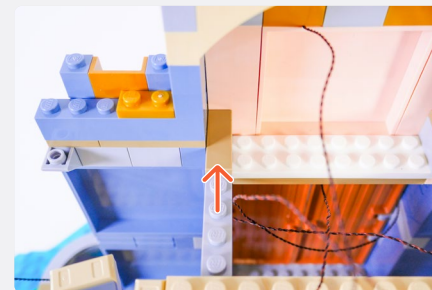

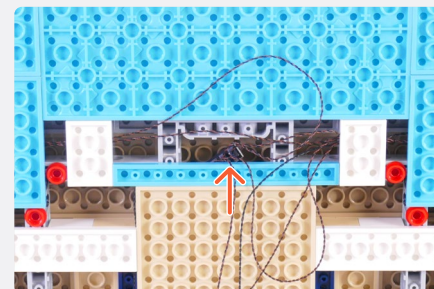
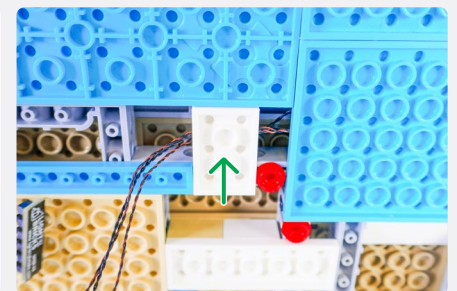
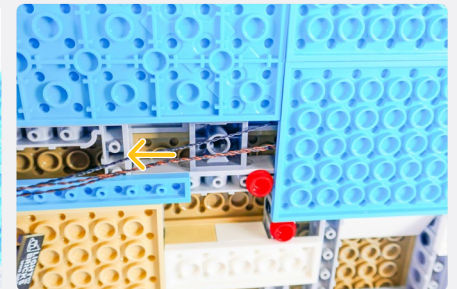
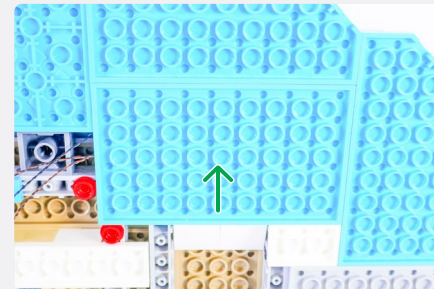
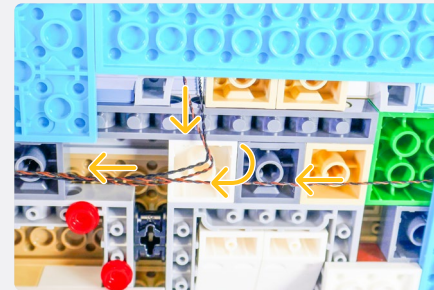
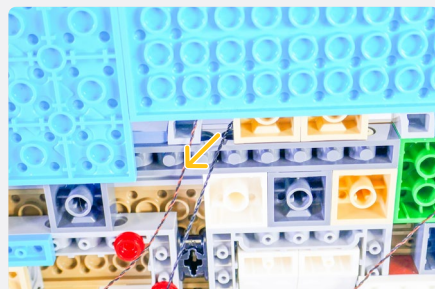
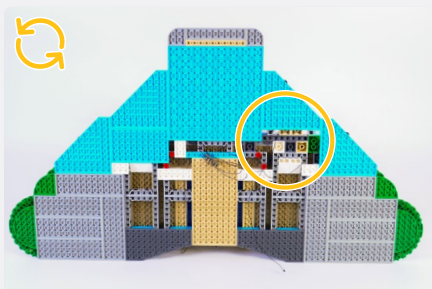
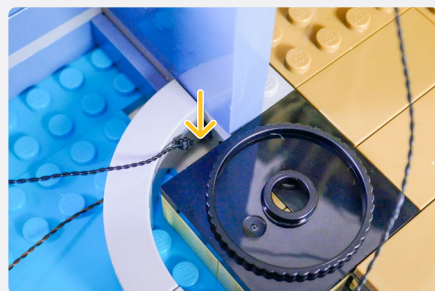
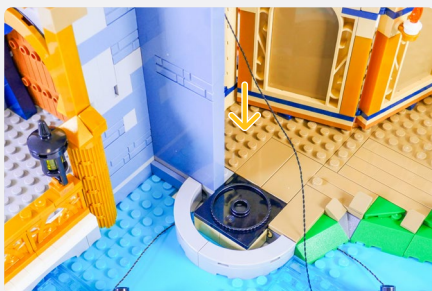
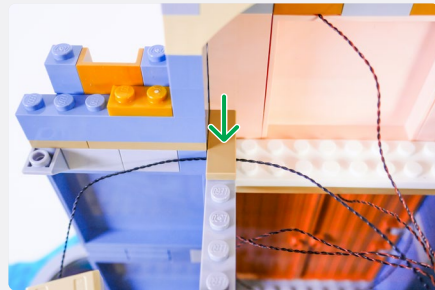
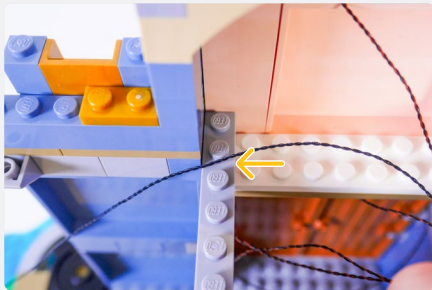

NOTE

Connect the 50cm Connecting Cable to the 6-Port Expansion Board from Step 6.

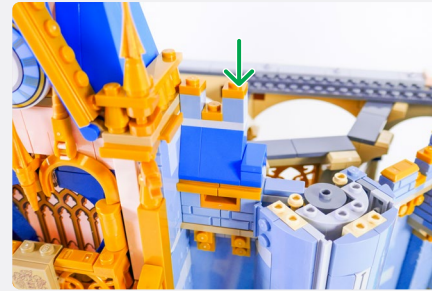
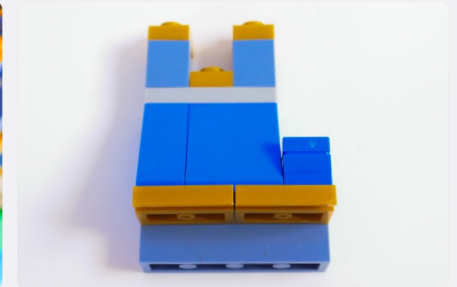
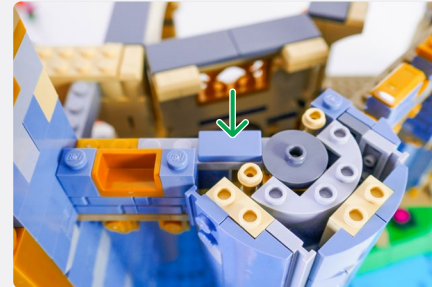
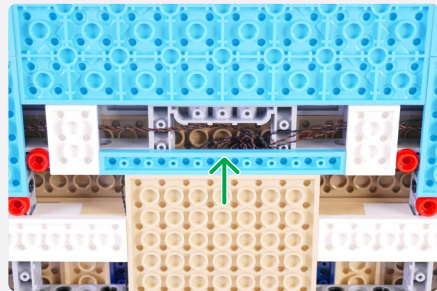
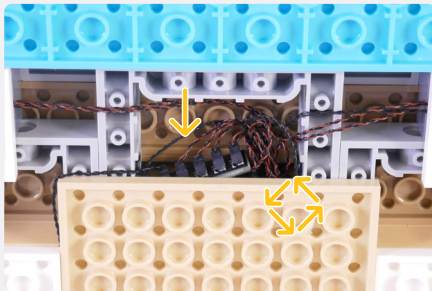
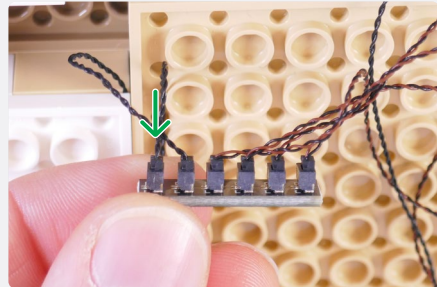

17

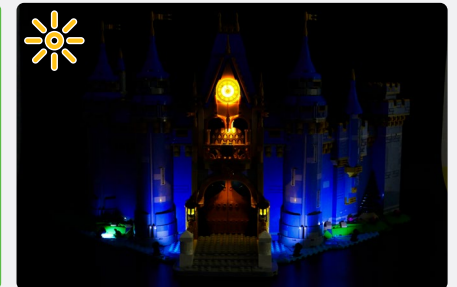
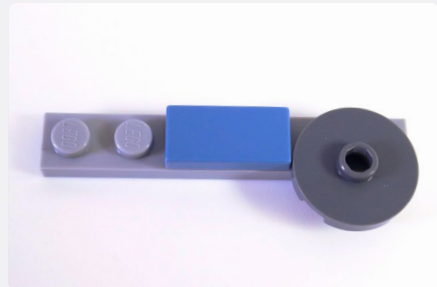

18

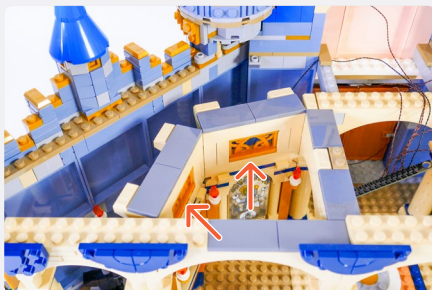

19

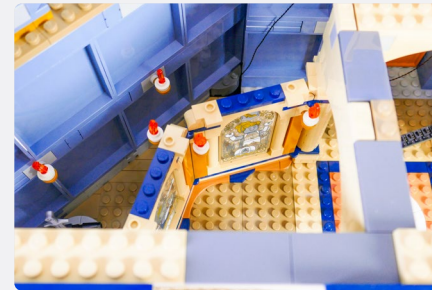

White 30cm Micro Bit Light



20

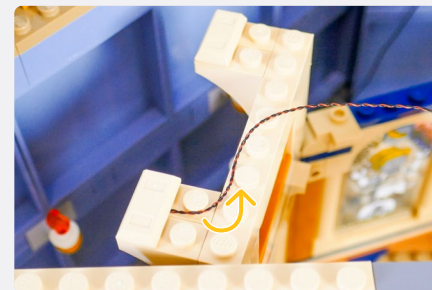
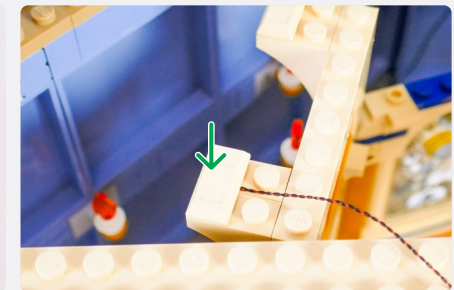
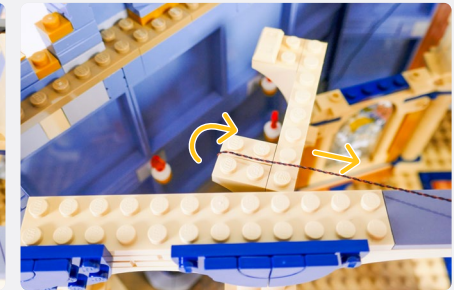
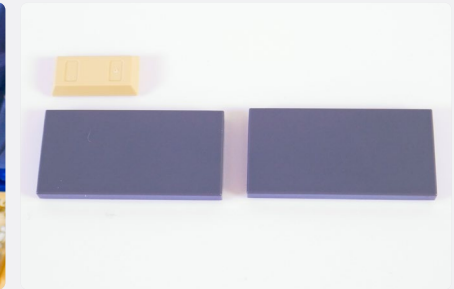
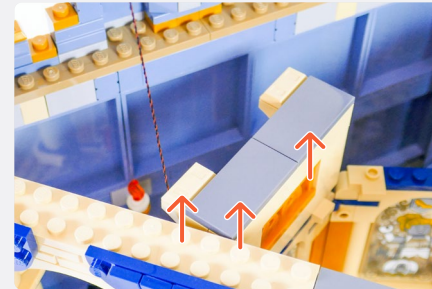
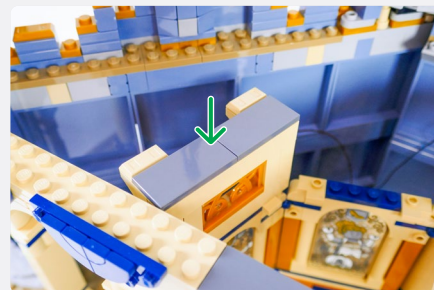
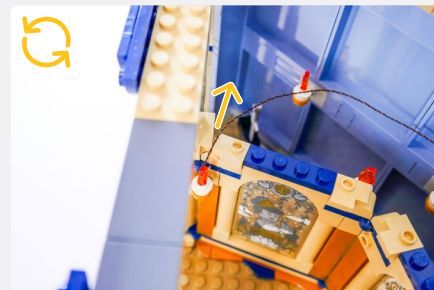
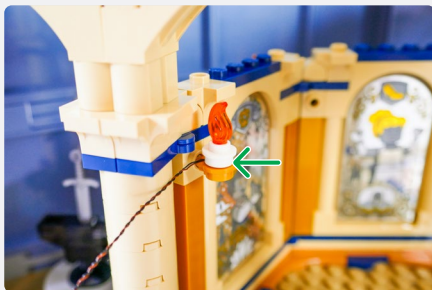

21

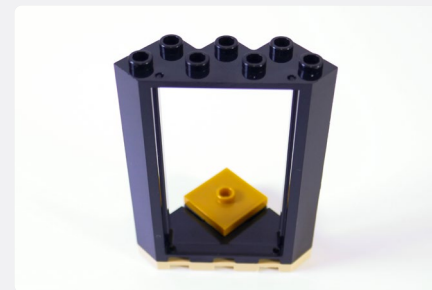
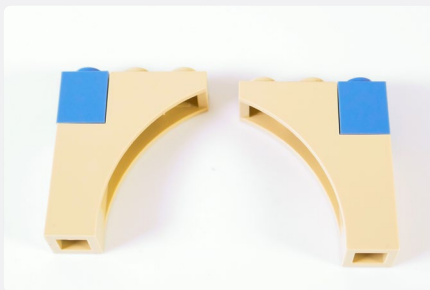

White 15cm Bit Light

Plate, Round 1x1 with Open Stud - Black

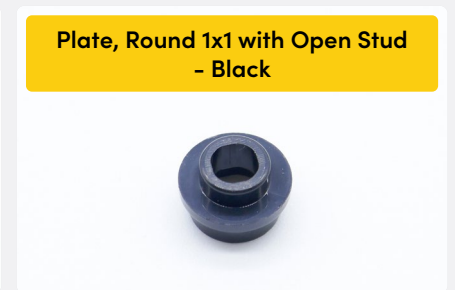

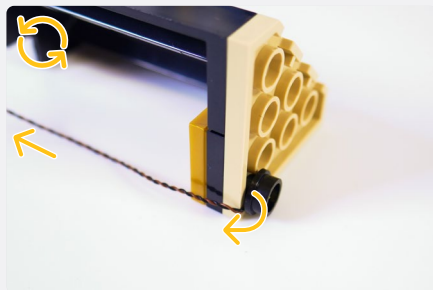
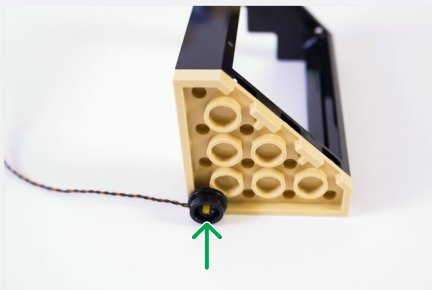
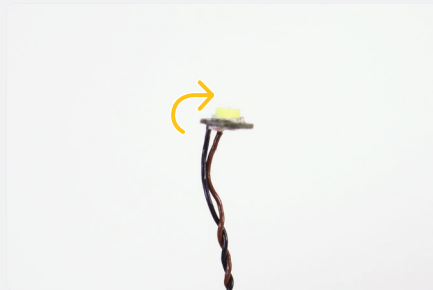
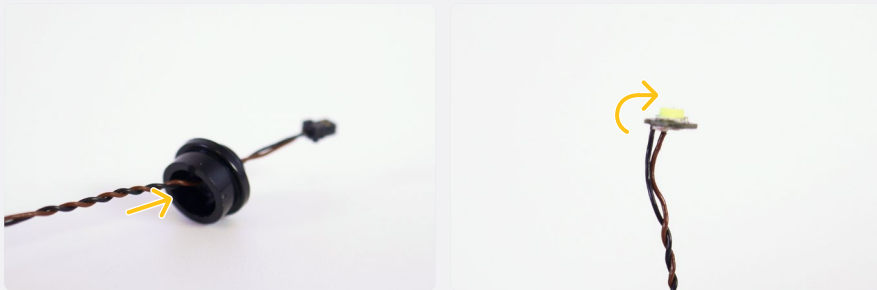

22

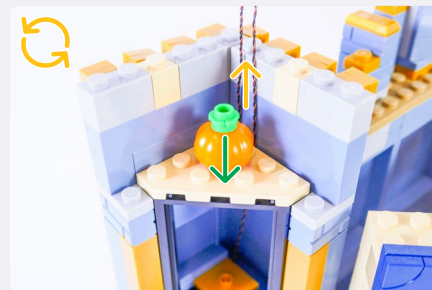
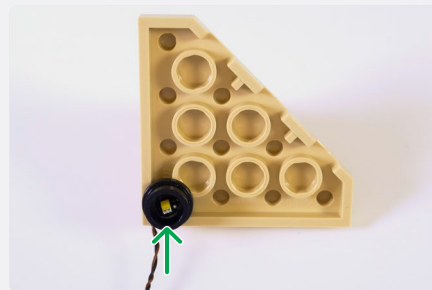
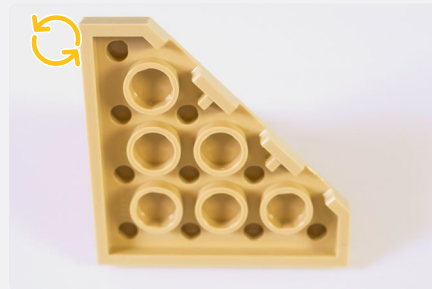
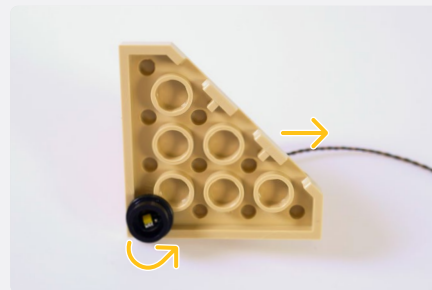



6-Port Expansion Board

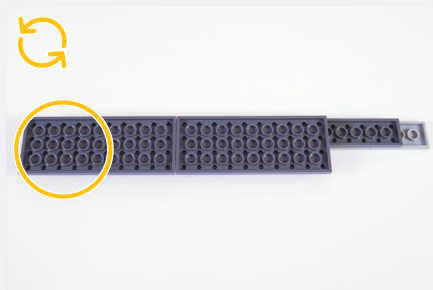
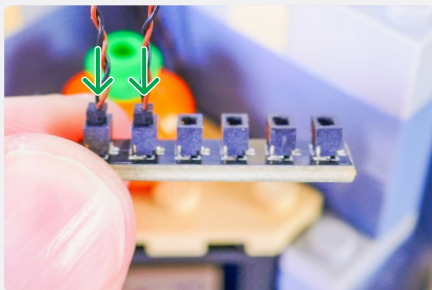
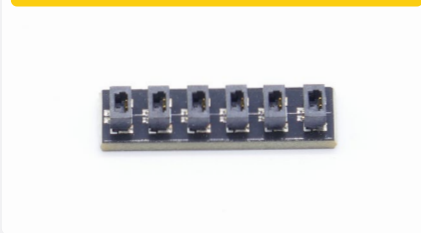

Yellow 15cm Bit Light



Plate, Round 2x2 with Rounded Bottom (Boat Stud) - Trans-Clear

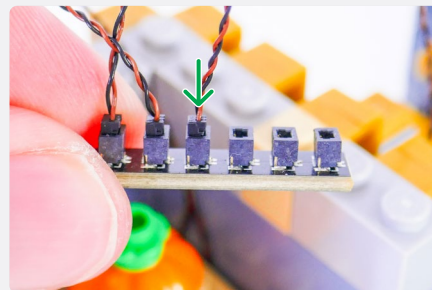
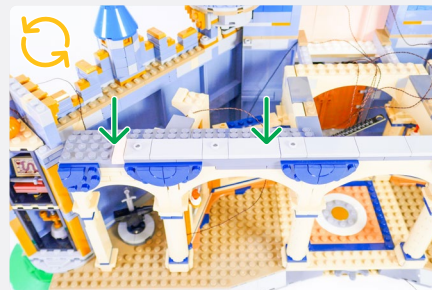
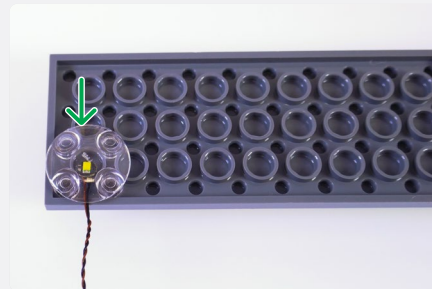
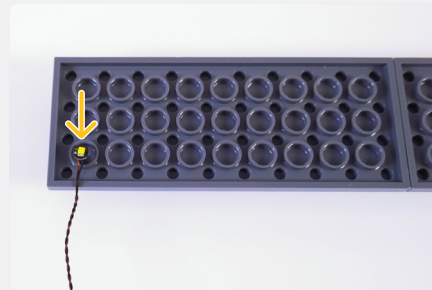

23

50cm Connecting Cable

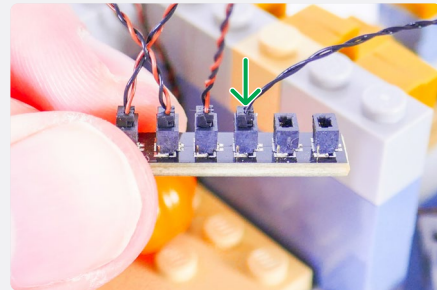

2x Adhesive Square



NOTE

Twist all cables connected to 6-Port Expansion Board excluding 50cm Connecting Cable.

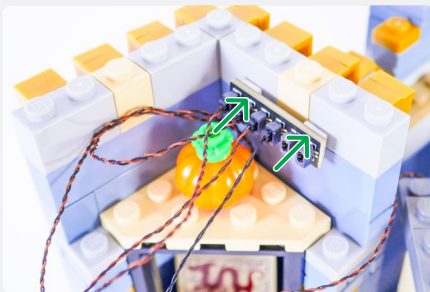

NOTE

Thread 50cm Connecting Cable as shown.

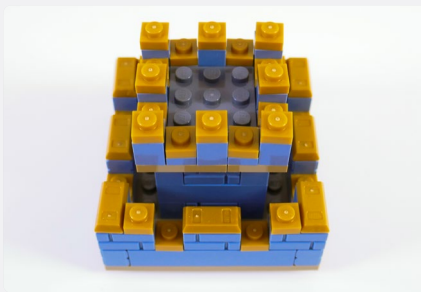
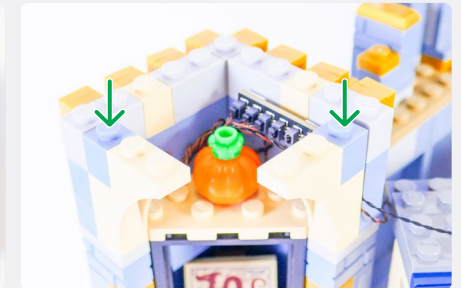
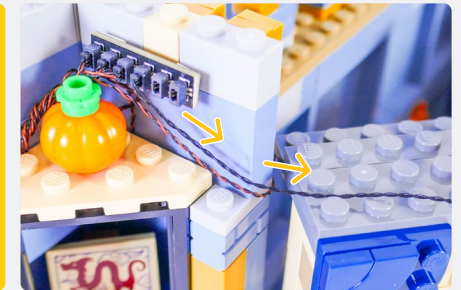

NOTE

Thread both the Loose 50cm Connecting Cable and the White 30cm Micro Bit Light from Step 19.



24

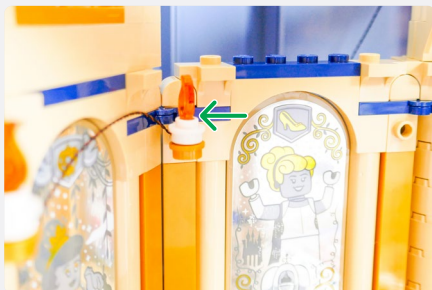
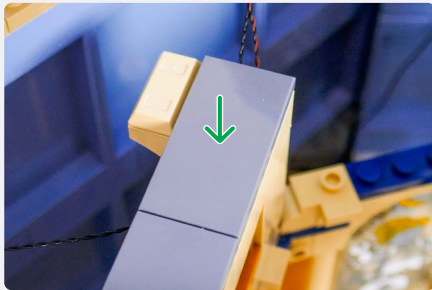
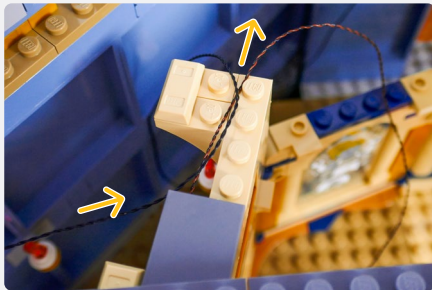

25

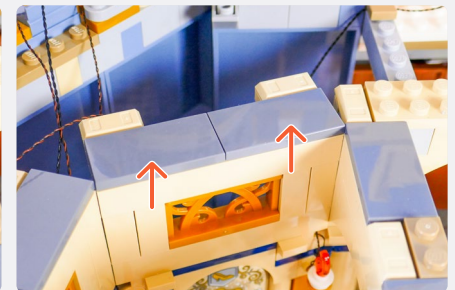
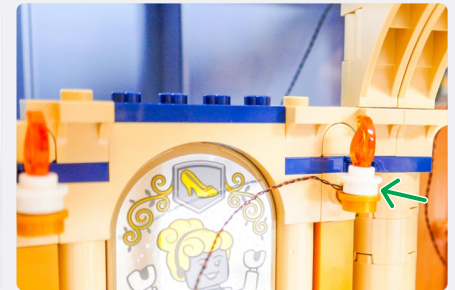
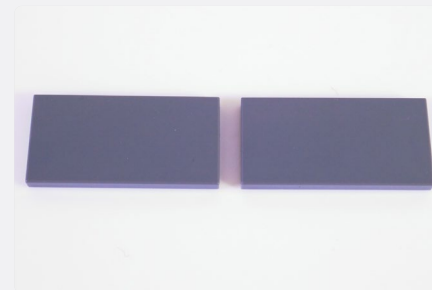

NOTE

Thread the first candle from this step along with the 50cm Connecting Cable and candle that was just installed.

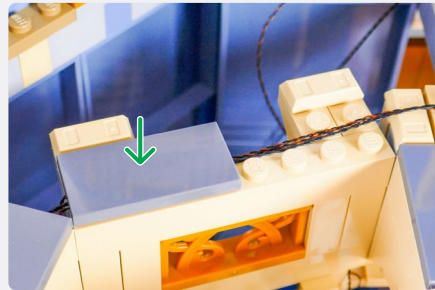
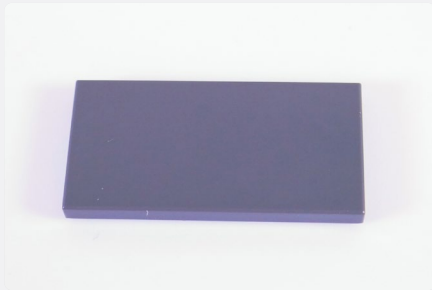
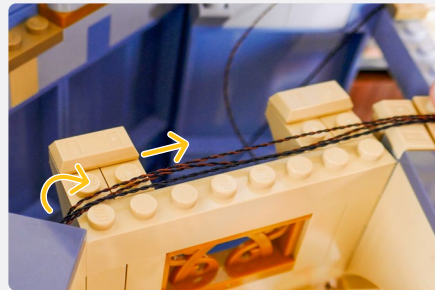

NOTE

Thread the second candle from this step along with the cables from the previous images.

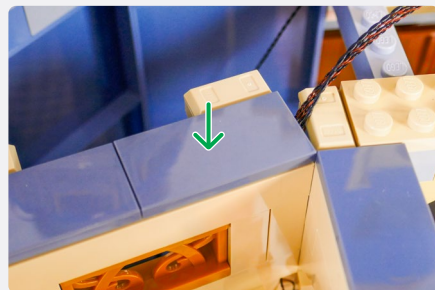
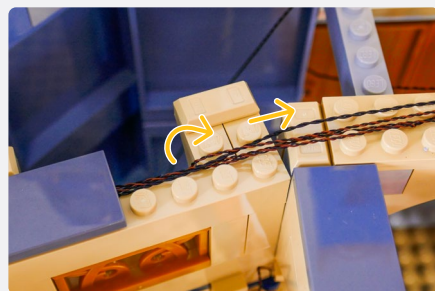

NOTE

Connect the 50cm Connecting Cable to the 12-Port Expansion Board. Then connect the 3x Micro Bit Lights into a 8-Port Micro Expansion Board.

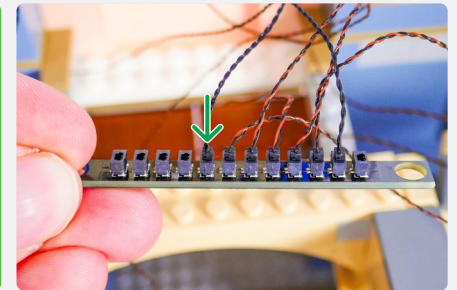

8-Port Micro Expansion Board

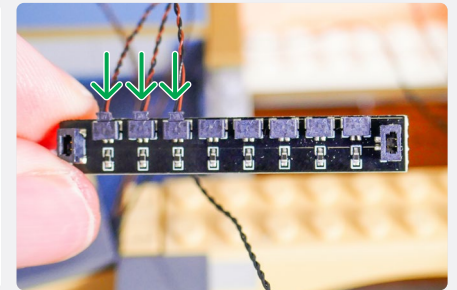

26

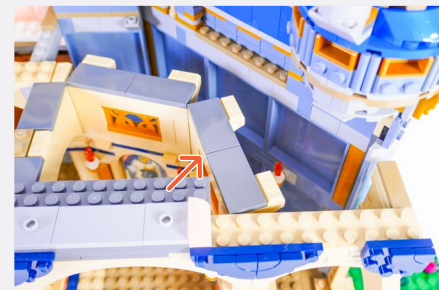
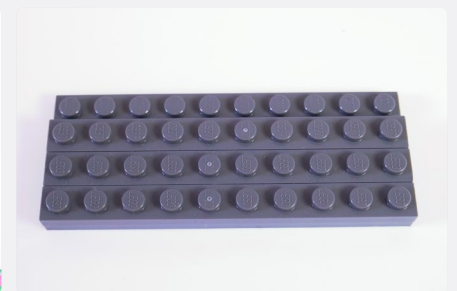
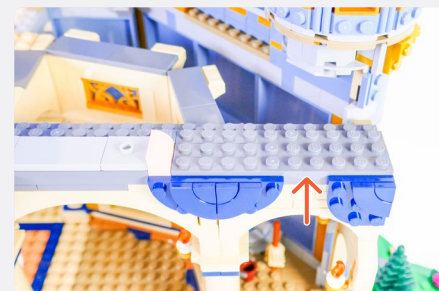

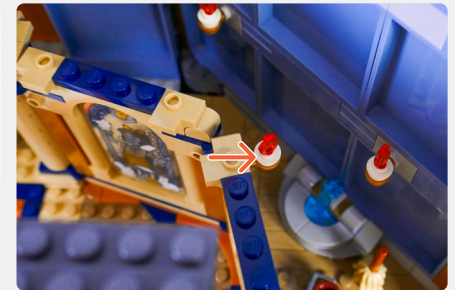
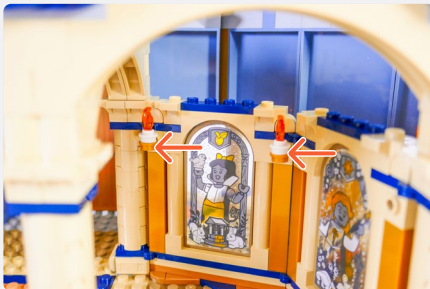
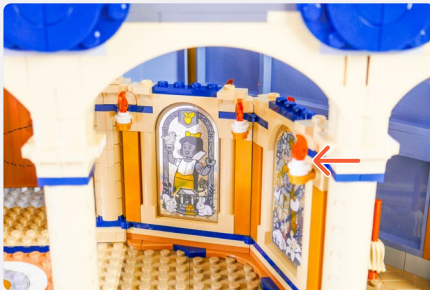
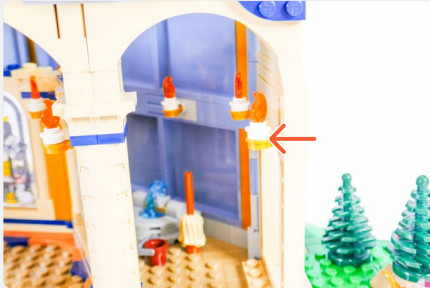

27

White 30cm Micro Bit Light

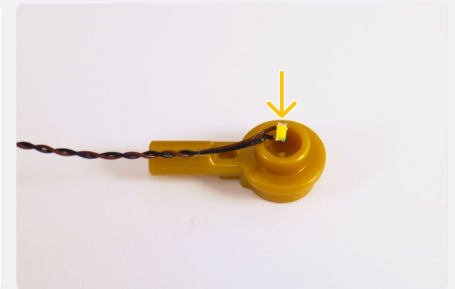

28

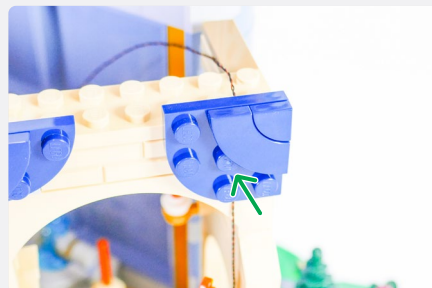
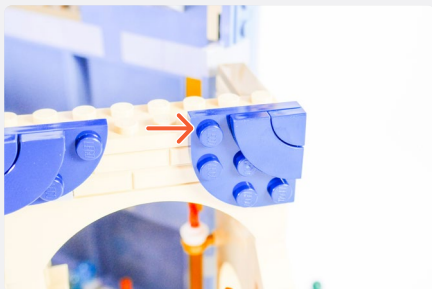
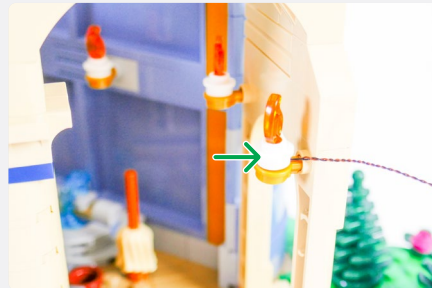

29

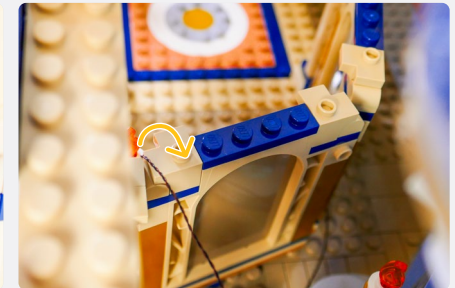

30

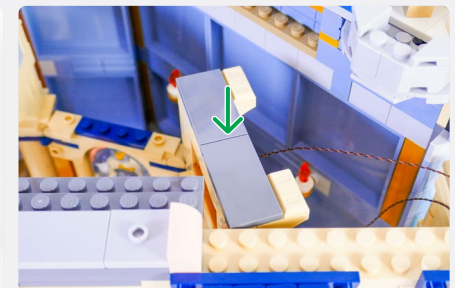
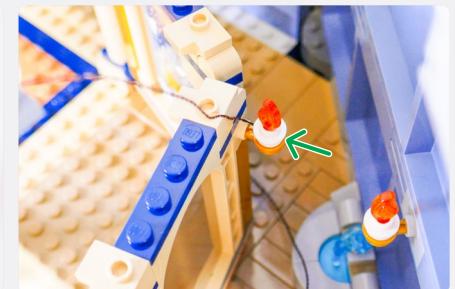

31

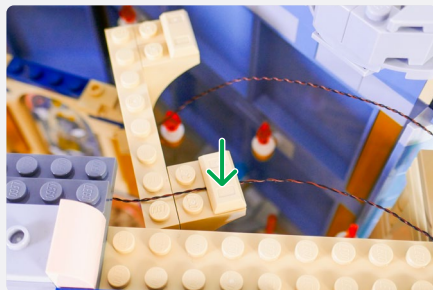
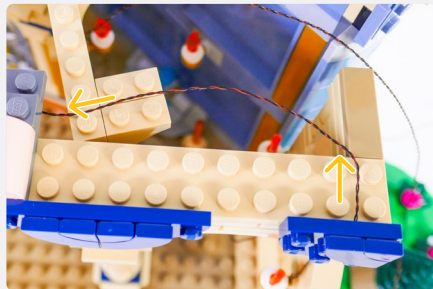
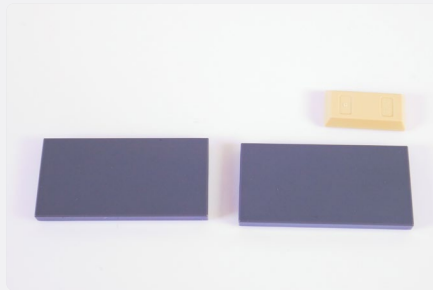
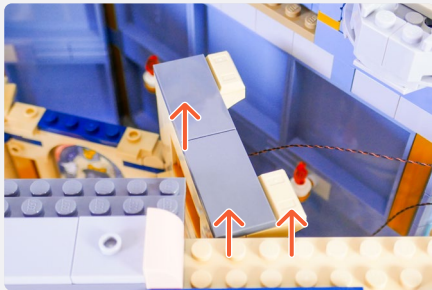

NOTE

Thread the two Micro Bit Lights from the front candles as shown.

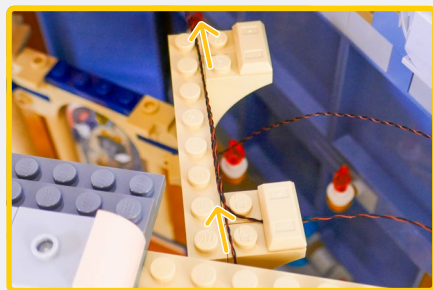

32

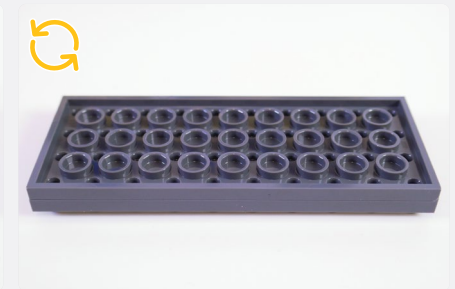
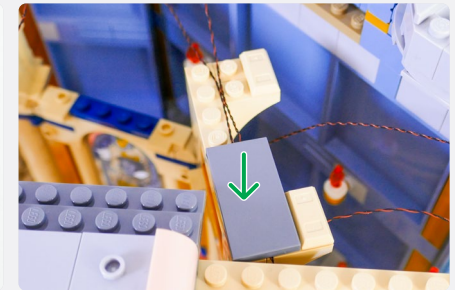

Yellow 30cm Bit Light

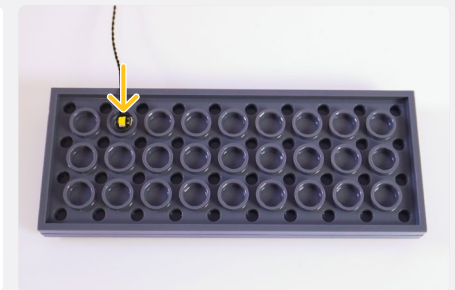

Plate, Round 2x2 with Rounded Bottom (Boat Stud) - Trans-Clear

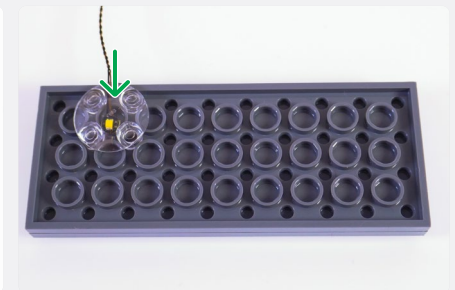

33

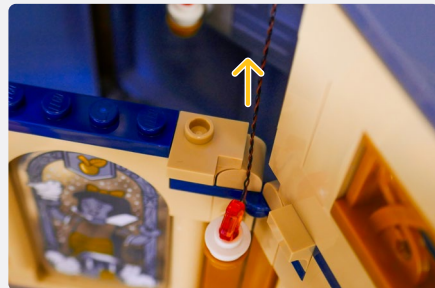
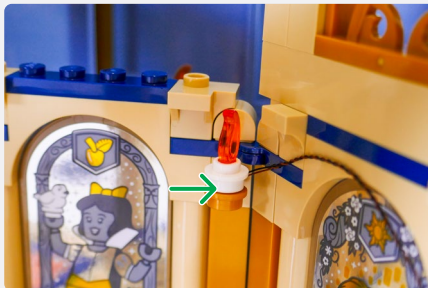
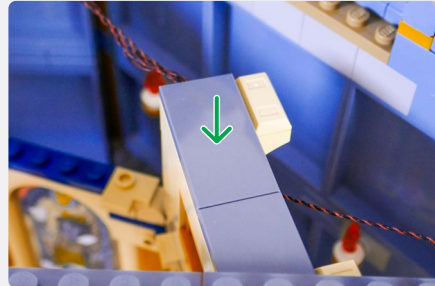
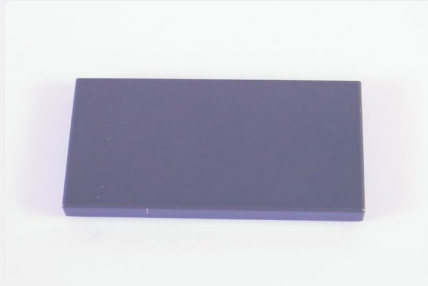

34

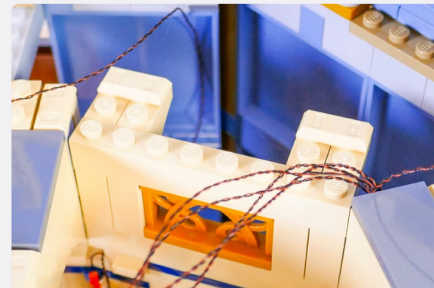
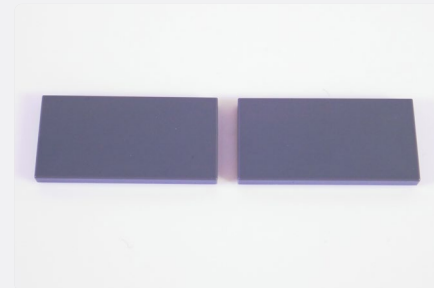
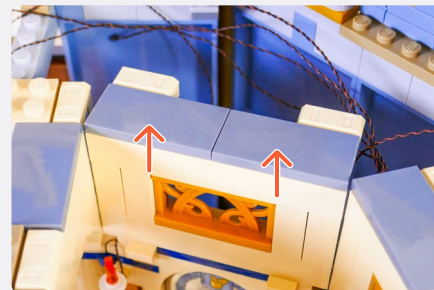
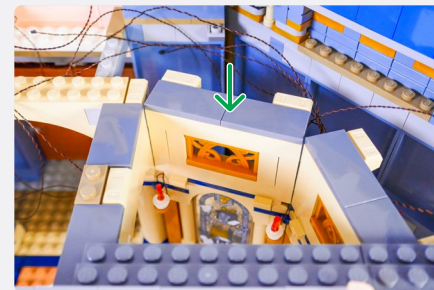
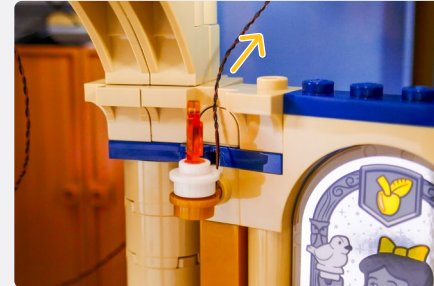
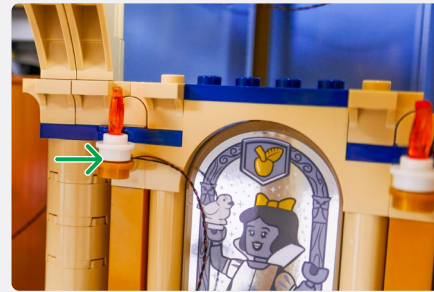

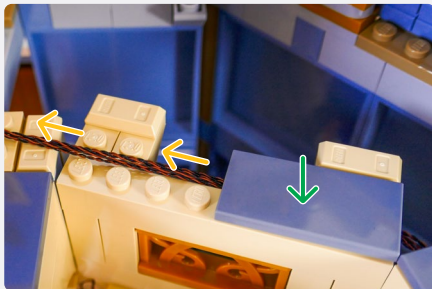
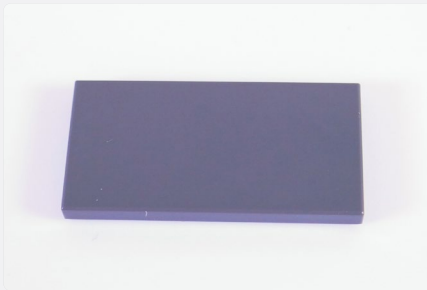

NOTE

Connect all loose Micro Bit Light cables to the 8-Port Micro Expansion Board.

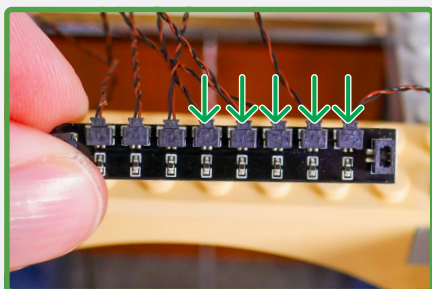

35

15cm Connecting Cable

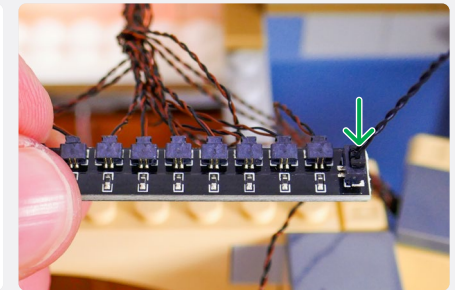

Flicker Effects Board

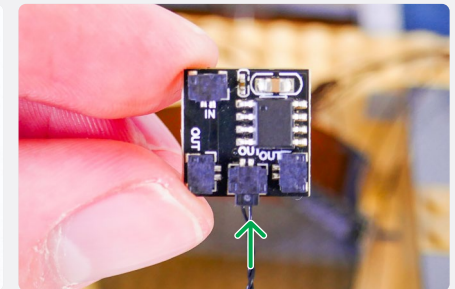
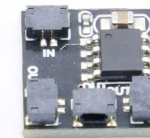

NOTE

Connect the "+5V" Port of the Flicker Effects Board to the 12-Port Expansion Board using a 5cm Connecting Cable.

5cm Connecting Cable

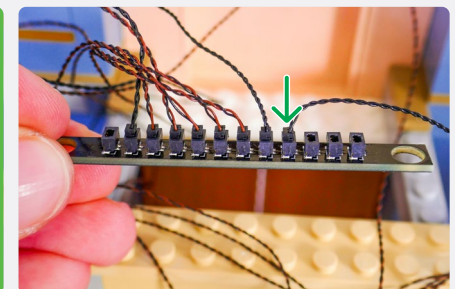
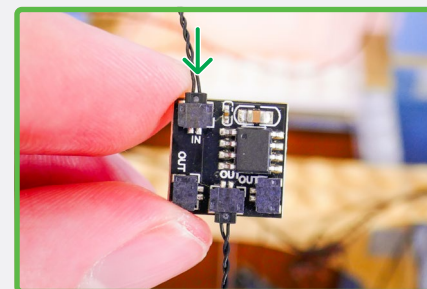

NOTE

Attach the Micro 8-Port Expansion Board to the back of the Tan arch pieces using Adhesive Squares.

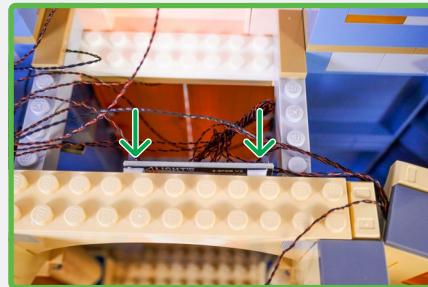
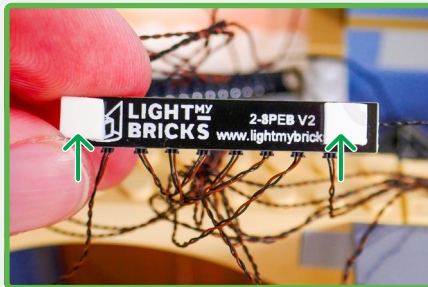

NOTE

Thread the cables from both sides between the studs as shown and towards the front of the castle.

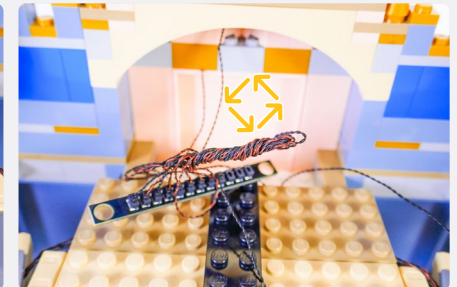
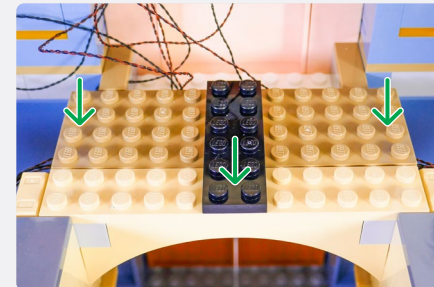
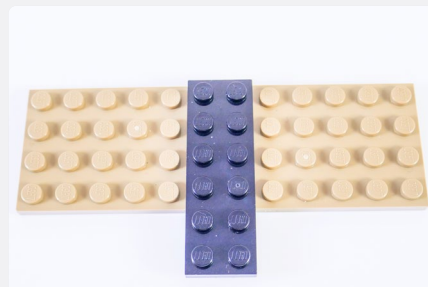
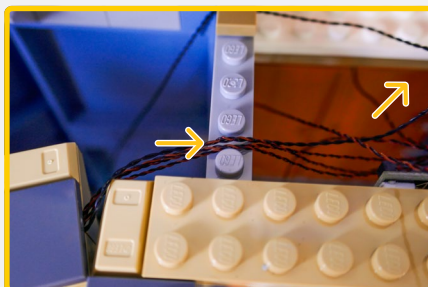
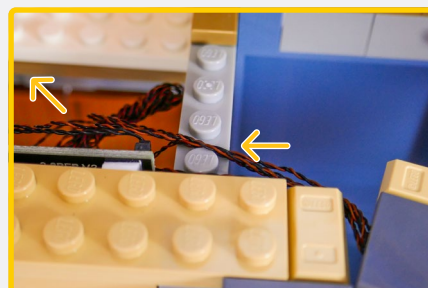

NOTE

Connect to a 5V USB Power Bank, 5V USB Wall Adaptor, or USB to AA Battery Pack (sold separately)



! If you experience any issues with the lights not working and suspect an issue with a component, please try a different port on the expansion board to verify where the fault lies (with the light or expansion board). To correct any issues with expansion board ports, please view the section addressing expansion board issues in our troubleshooting section. **i**

36

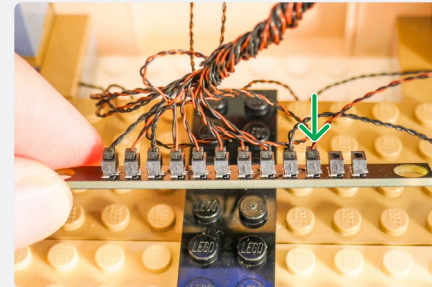
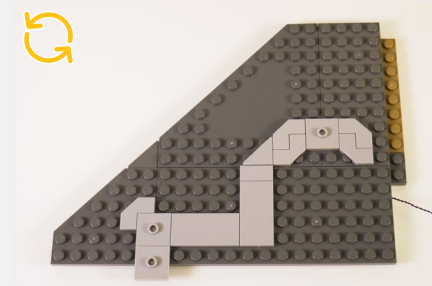
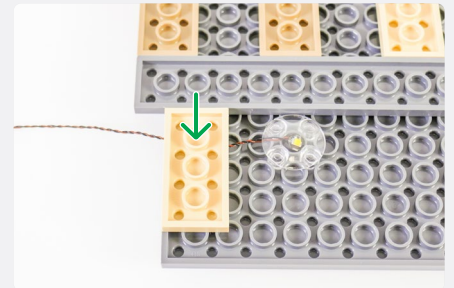
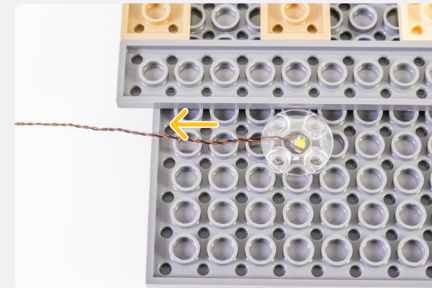
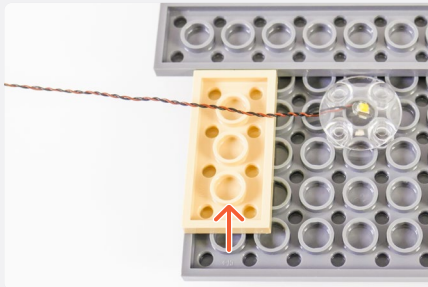
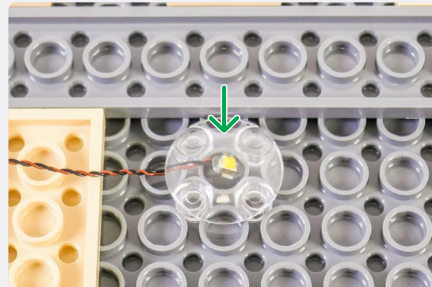
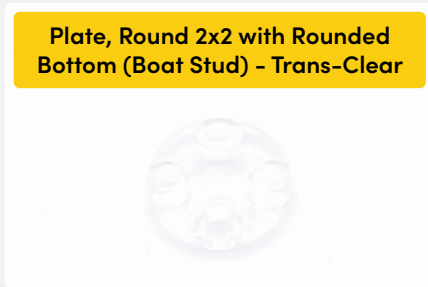
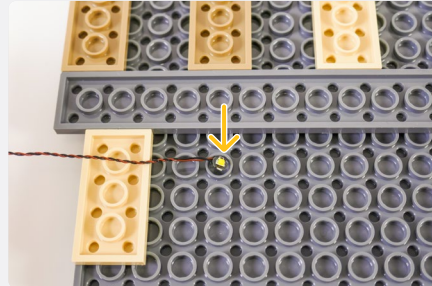
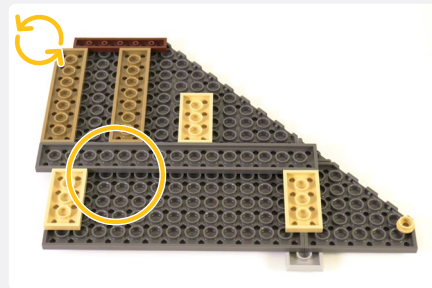
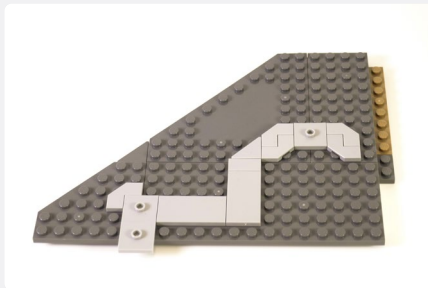

37

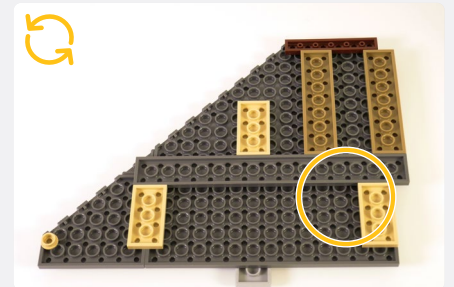
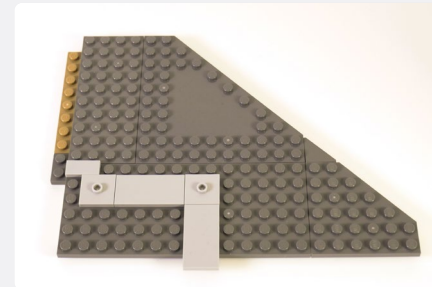

Yellow 30cm Bit Light

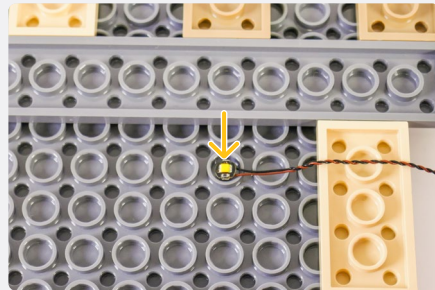

Plate, Round 2x2 with Rounded Bottom (Boat Stud) - Trans-Clear

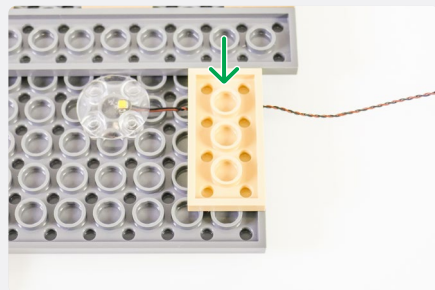
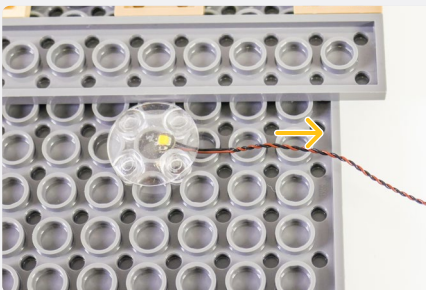
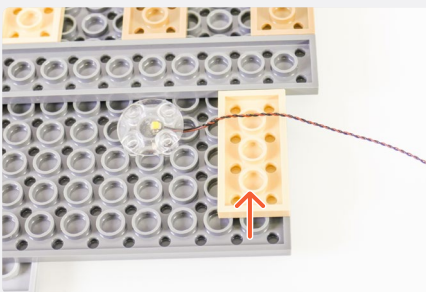
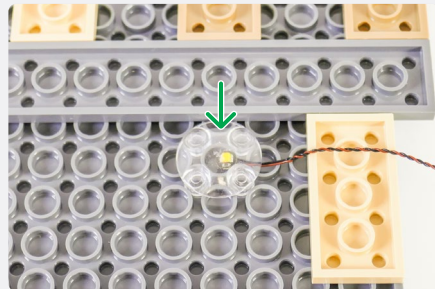

38

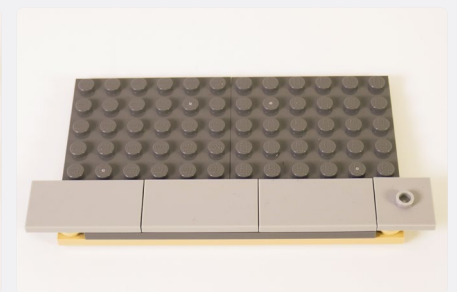
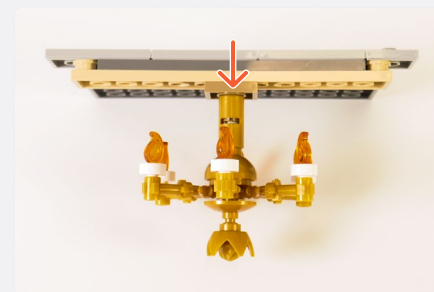
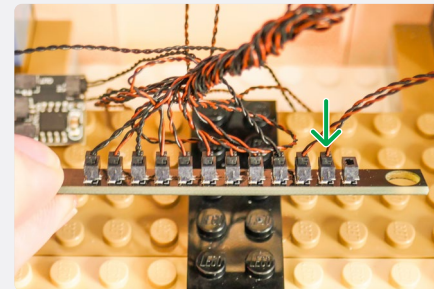
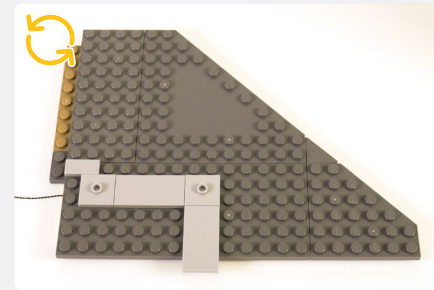

39

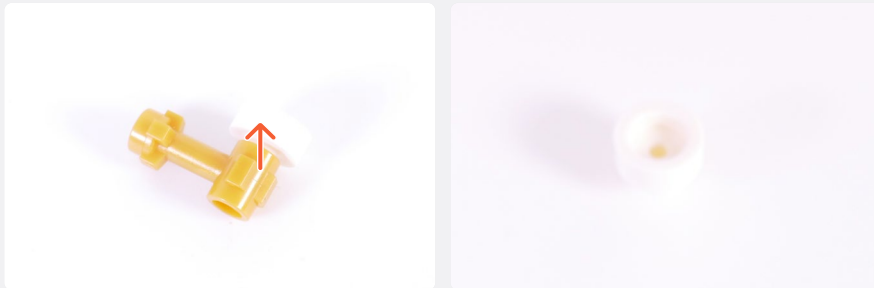
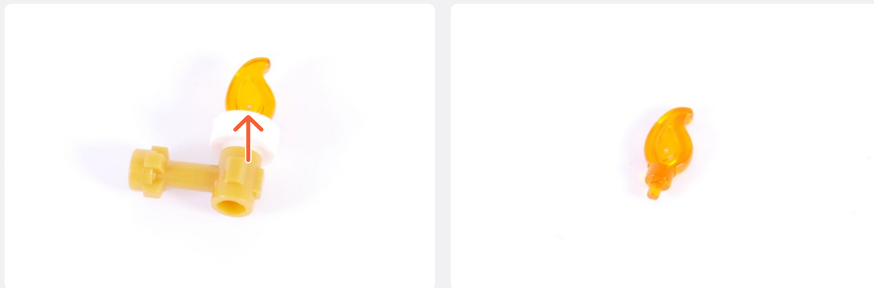

Plate, Round 1x1 with Open Stud - White

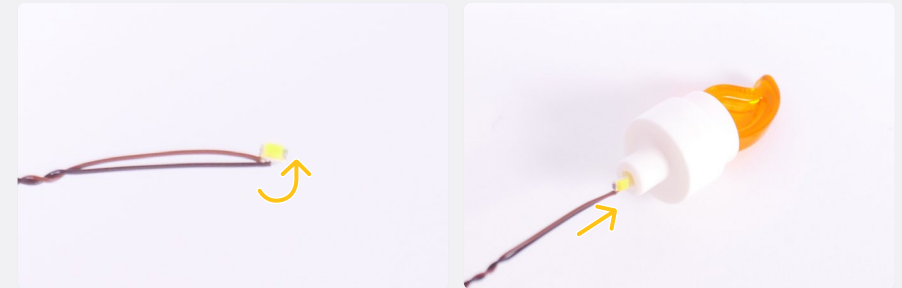
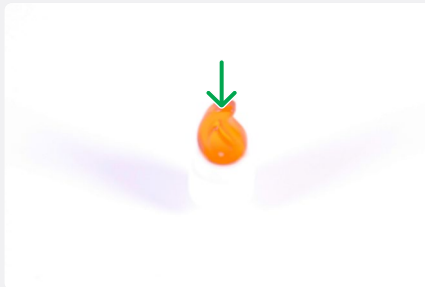

40

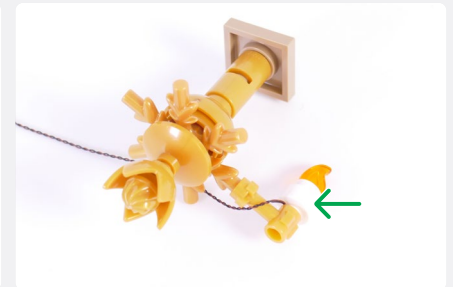

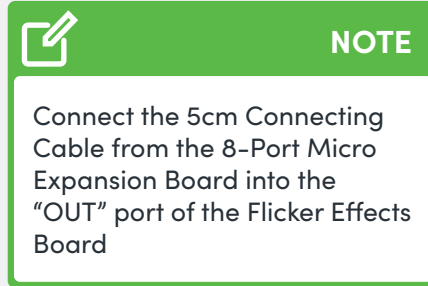
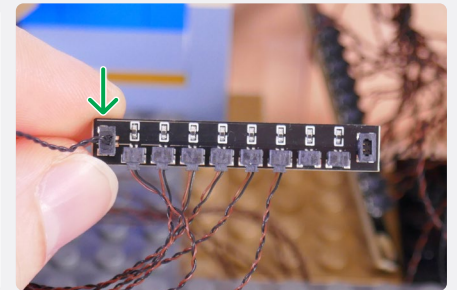
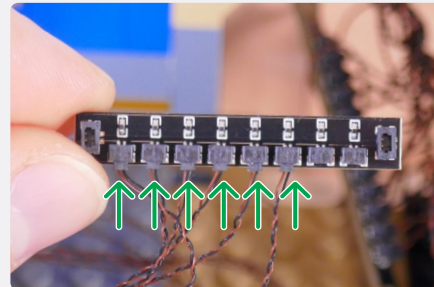
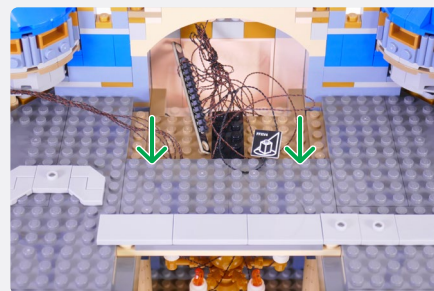
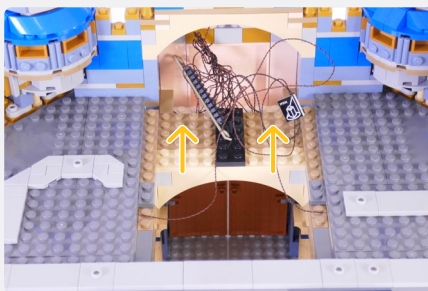
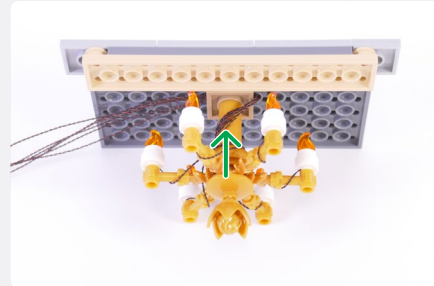
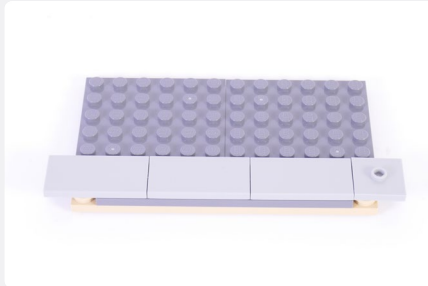
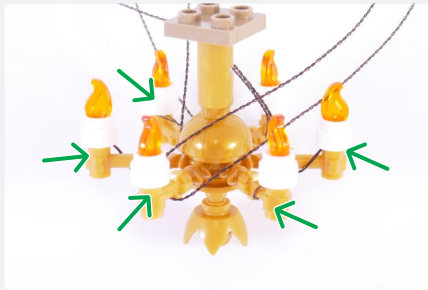

Connect the 5cm Connecting Cable from the 8-Port Micro Expansion Board into the "OUT" port of the Flicker Effects Board

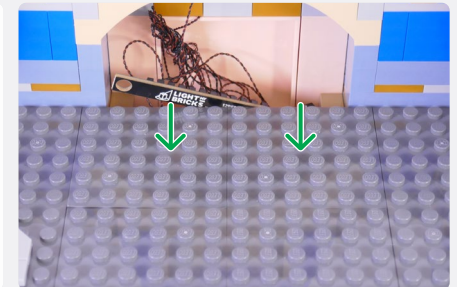
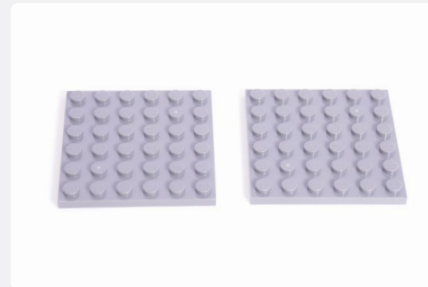
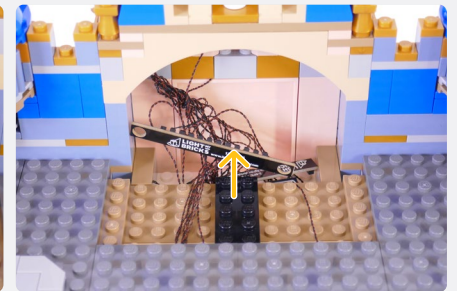
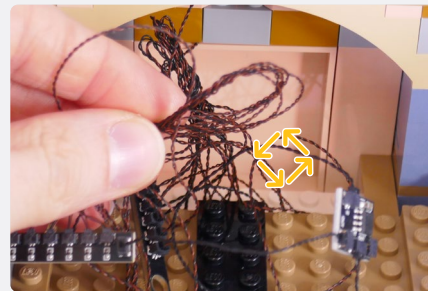
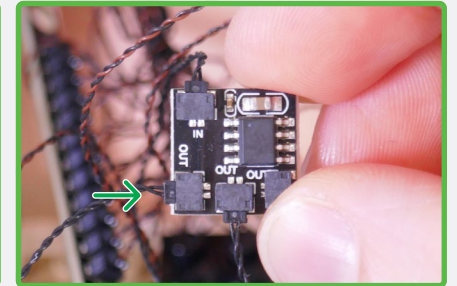

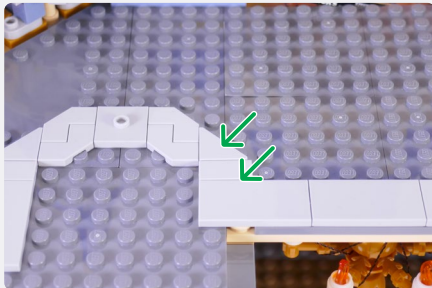
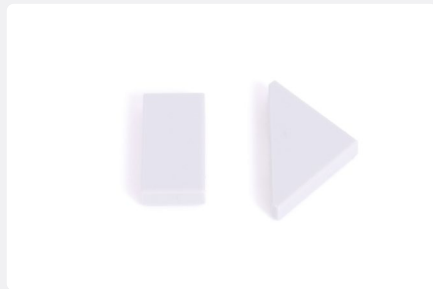
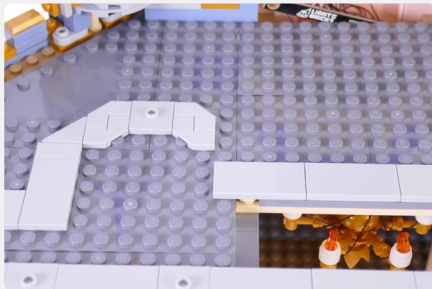

NOTE

Connect to a 5V USB Power Bank, 5V USB Wall Adaptor, or USB to AA Battery Pack (sold separately)



41



! If you experience any issues with the lights not working and suspect an issue with a component, please try a different port on the expansion board to verify where the fault lies (with the light or expansion board). To correct any issues with expansion board ports, please view the section addressing expansion board issues in our troubleshooting section. i

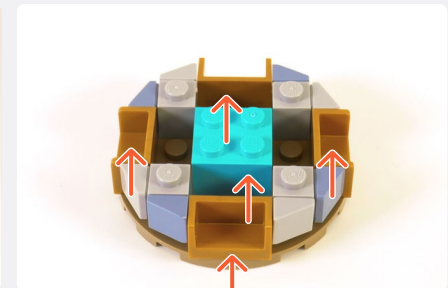

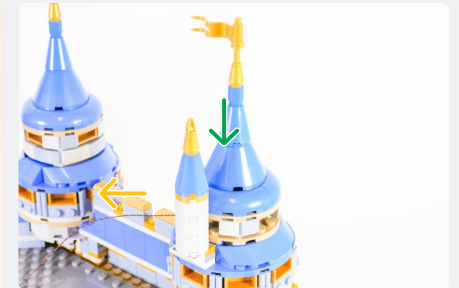
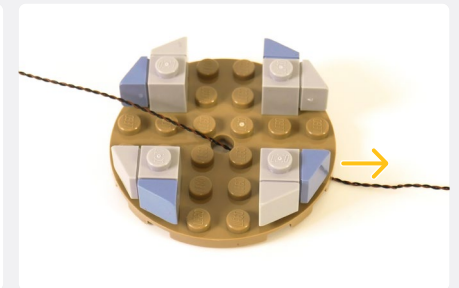
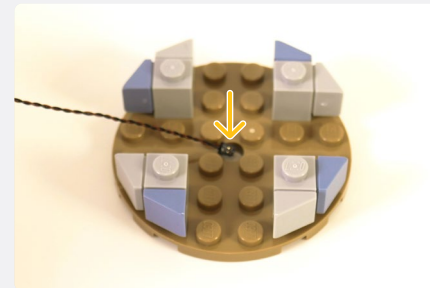
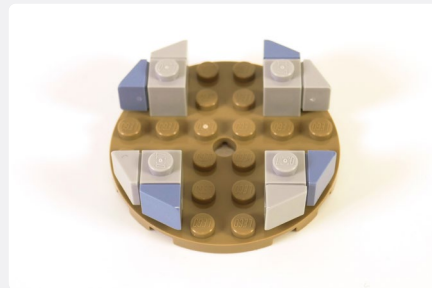
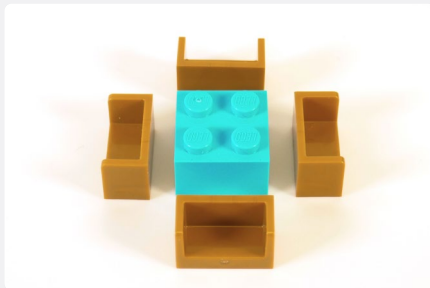

White 30cm Bit Light

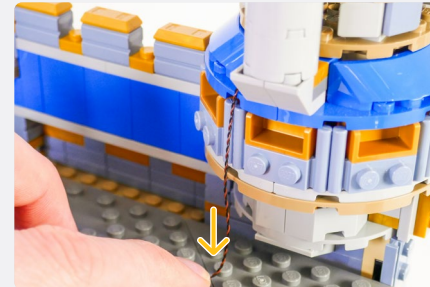
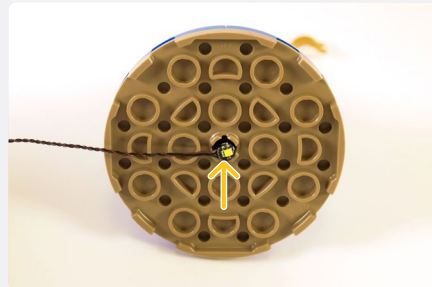
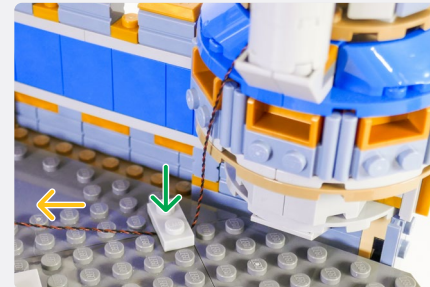
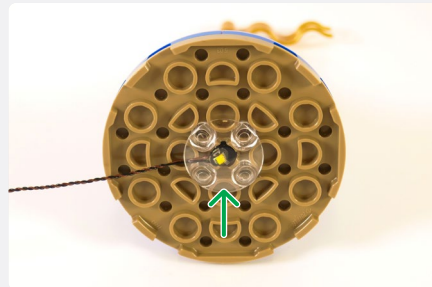

Plate 1x2 - Light Bluish Gray



Plate, Round 2x2 with Rounded Bottom (Boat Stud) - Trans-Clear



42

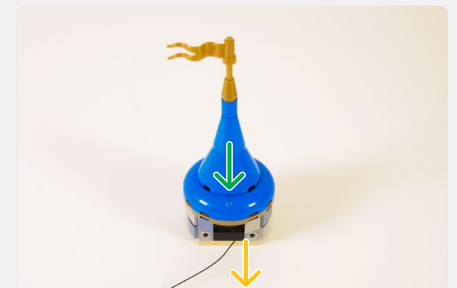
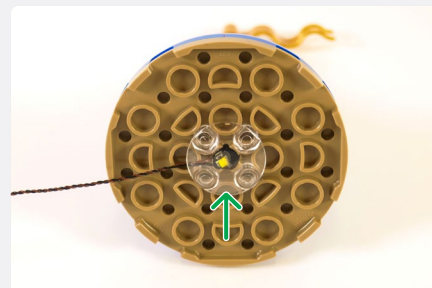
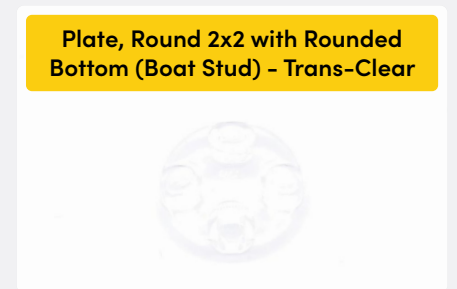
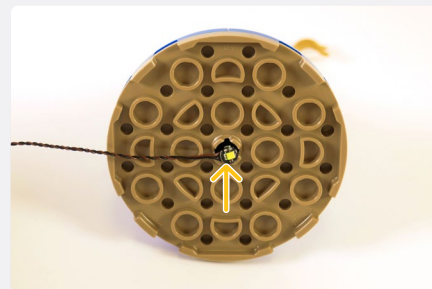
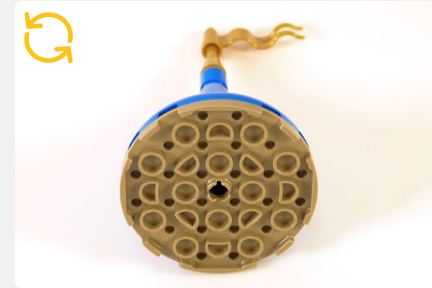
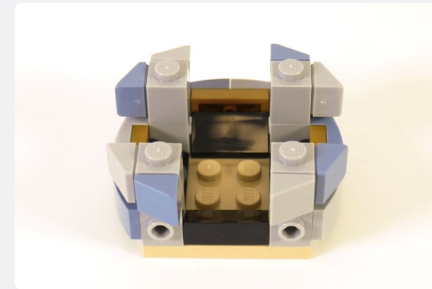
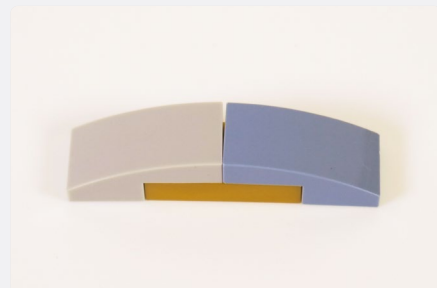
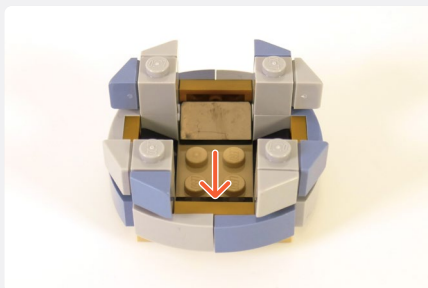
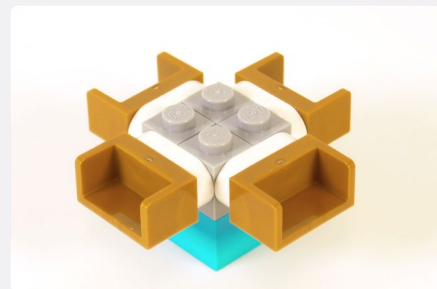
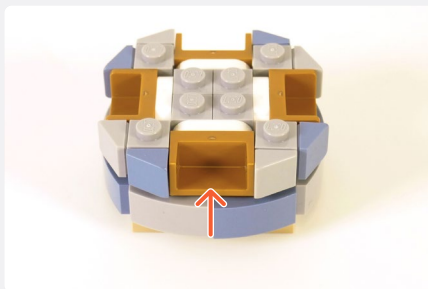

43

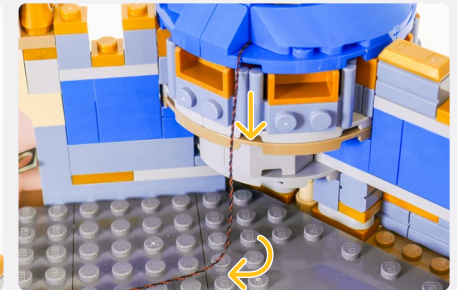
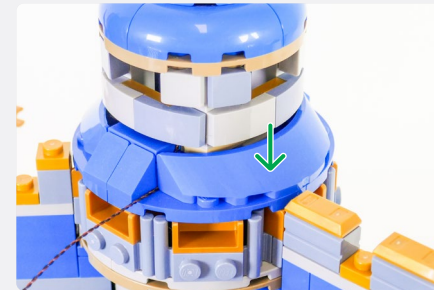
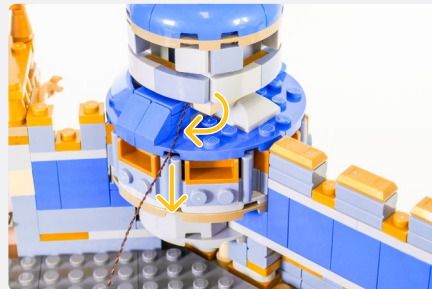
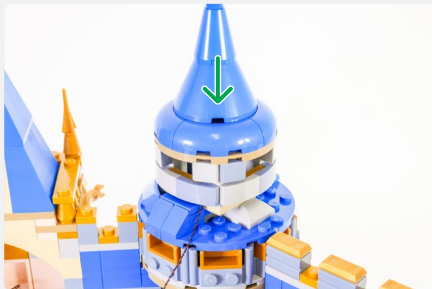

NOTE

Thread the two loose cables together towards the indicated position.

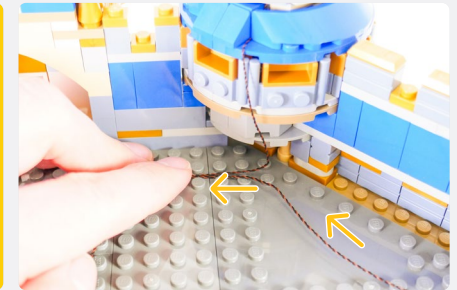
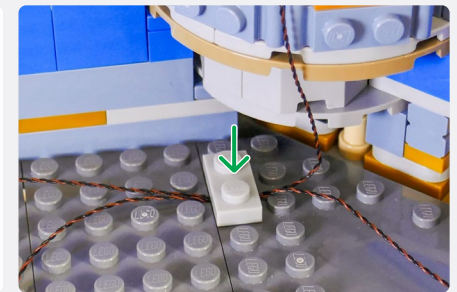
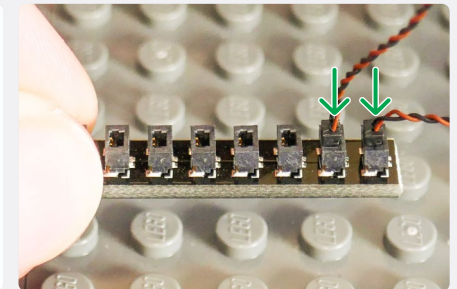

Plate 1x2 - Light Bluish Gray



8-Port Expansion Board



44

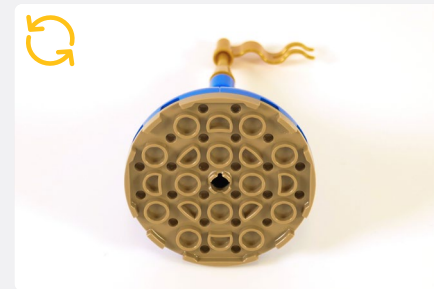
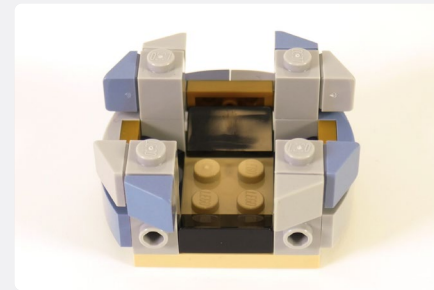
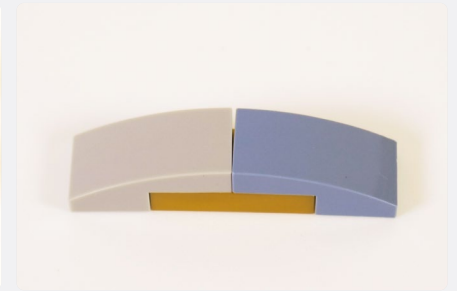
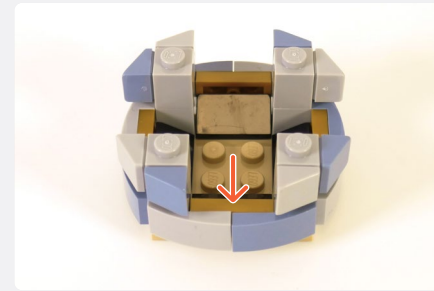
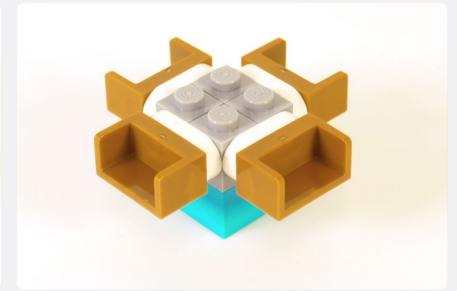
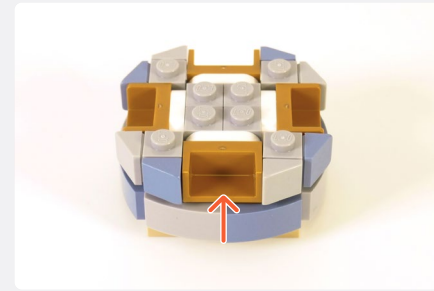

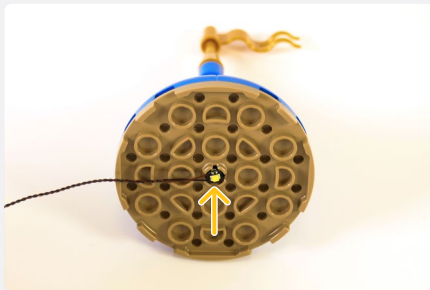

Plate, Round 2x2 with Rounded Bottom (Boat Stud) - Trans-Clear

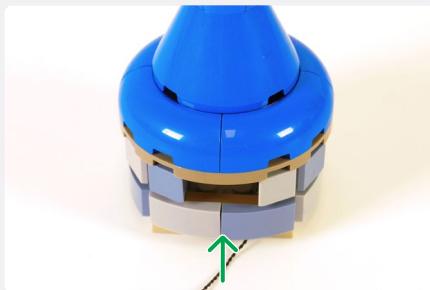
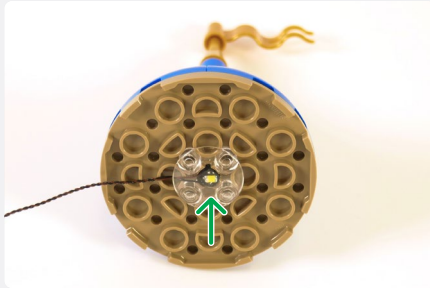

45

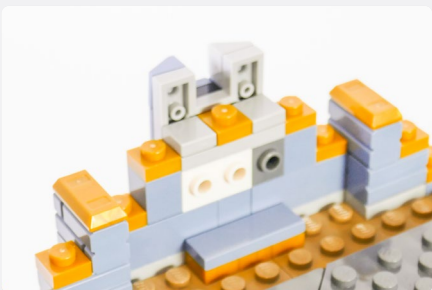
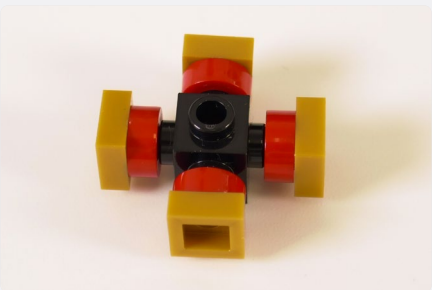
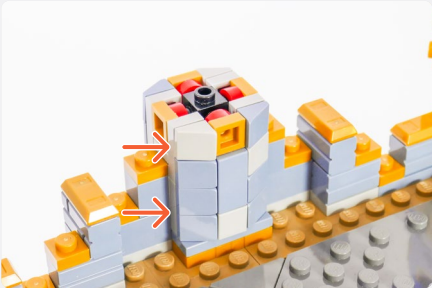
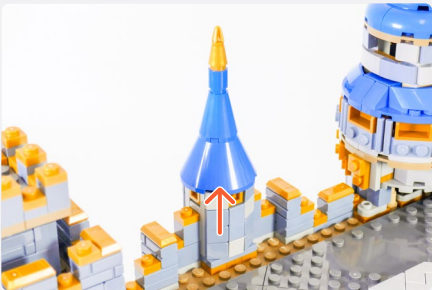

White 30cm Bit Light



Brick, Round 1x1 Open Stud - Trans-Clear

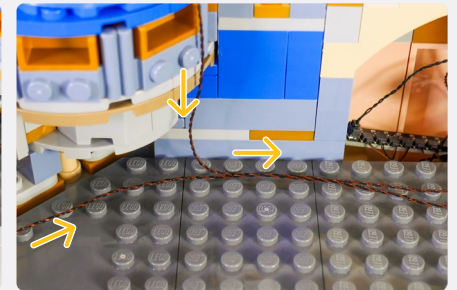
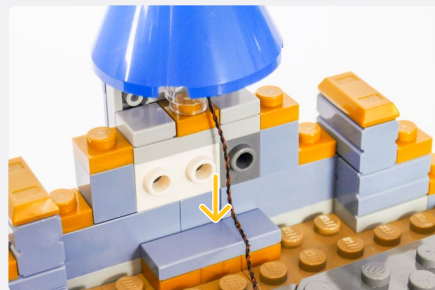
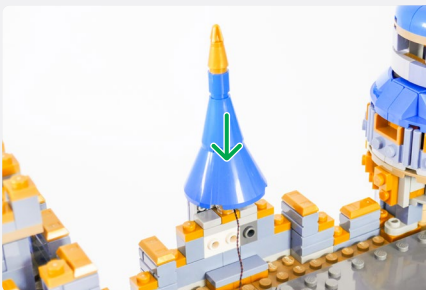
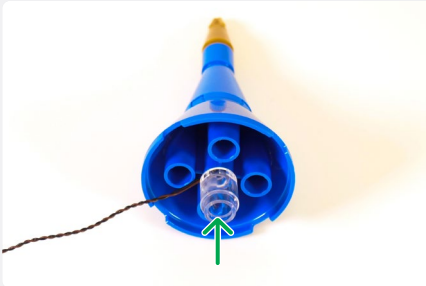
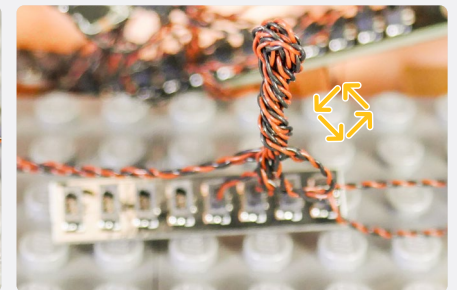
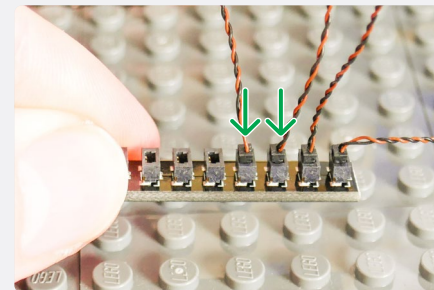
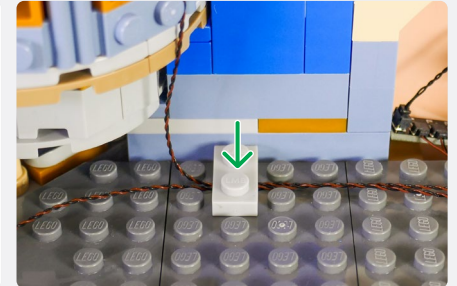
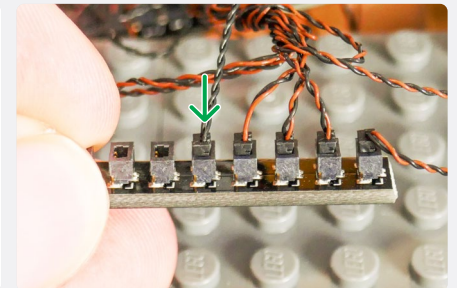

Plate 1x2 - Light Bluish Gray



5cm Connecting Cable



46

NOTE

Connect the other end of the 5cm Connecting Cable into the 12-Port Expansion Board.

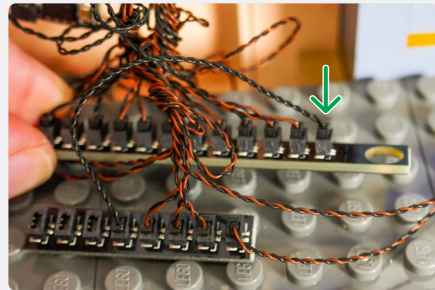

Plate, Modified 1x2 with Bar Handle on Side Closed Ends - Black

Tile, Modified 1x1 with Open O Clip - Black

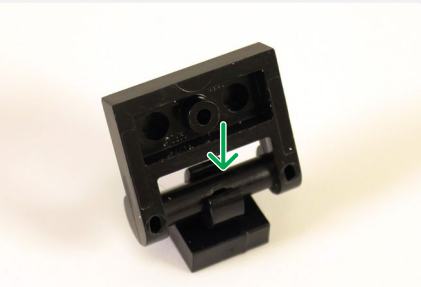
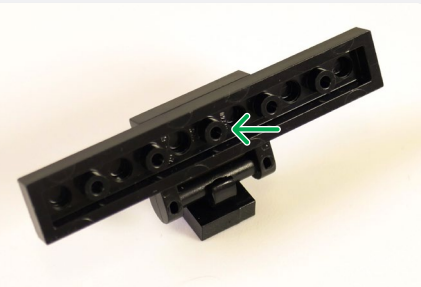

Plate 1x6 - Black



RGB Strip Light 2.0

RGB 15cm Connecting Cable

x2



RGBIR Control Board

NOTE

Connect the RGB 15cm Connecting Cable to the "OUT" port on the RGB IR Control Board.

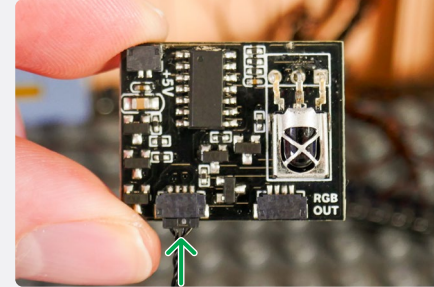

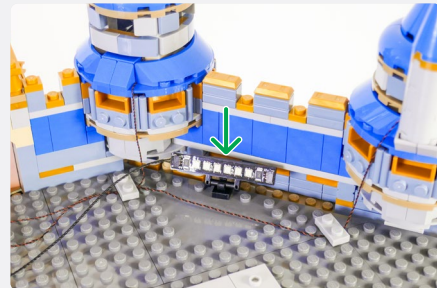
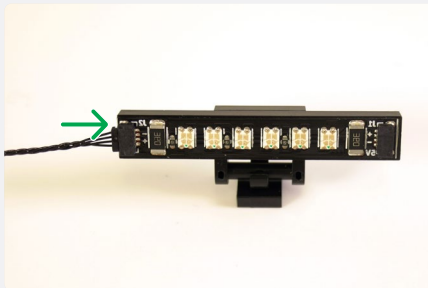

47

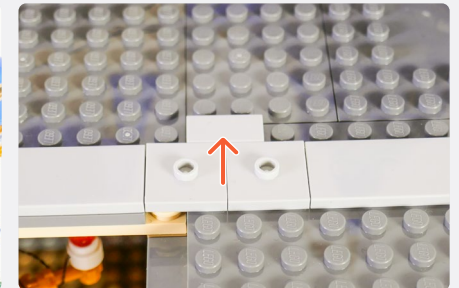

NOTE

Connect the RGB 15cm Connecting Cable to the second "OUT" port on the RGB IR Control Board.

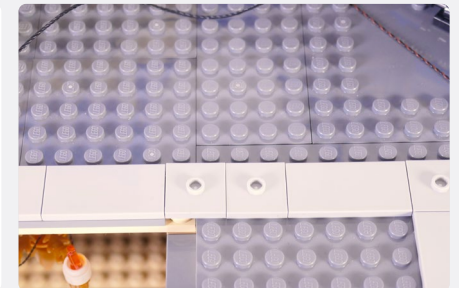
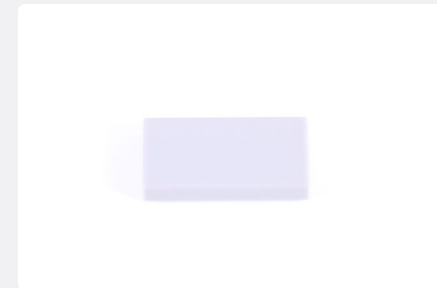
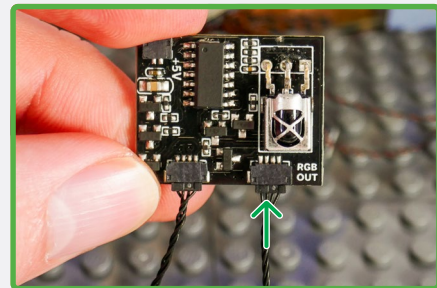

5cm Connecting Cable

NOTE

Connect the 5cm Connecting Cable to the "+5V" port of the RGB IR Control Board, then to the 8-Port Expansion Board.

Wireless Power Connector Tile

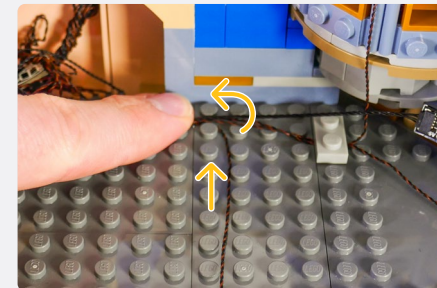
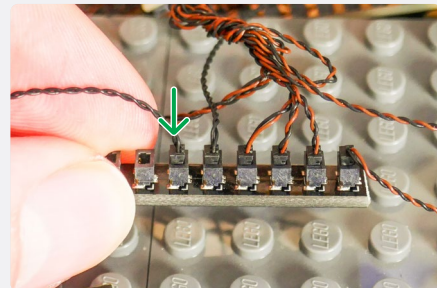
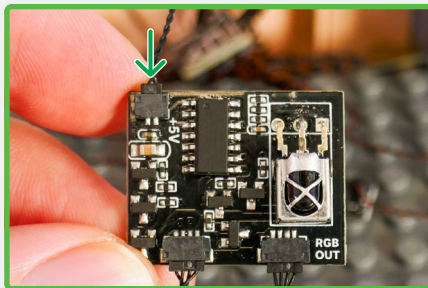
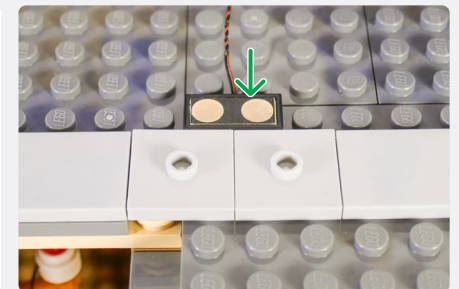

48

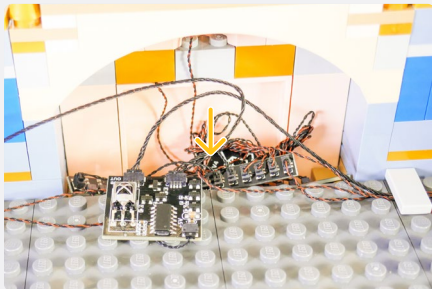
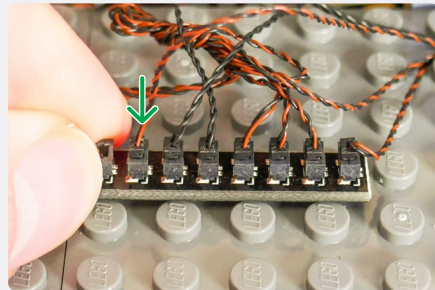
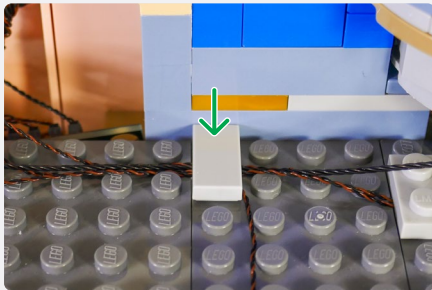

! If you experience any issues with the lights not working and suspect an issue with a component, please try a different port on the expansion board to verify where the fault lies (with the light or expansion board). To correct any issues with expansion board ports, please view the section addressing expansion board issues in our troubleshooting section.

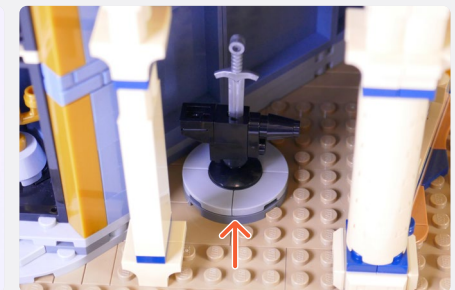
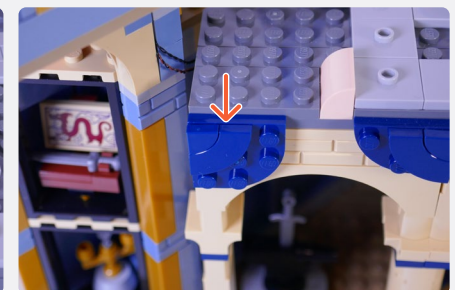
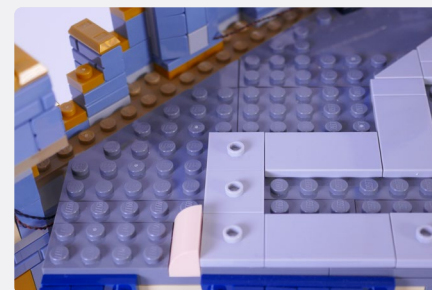
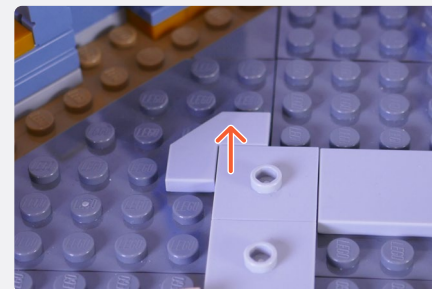

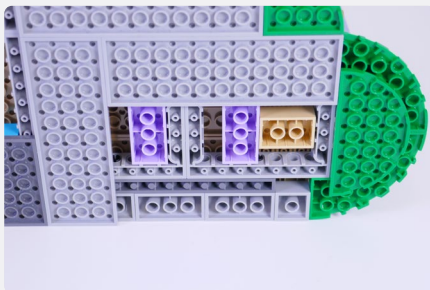
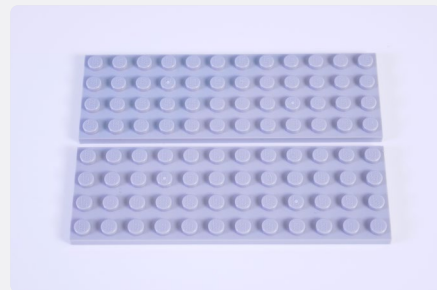
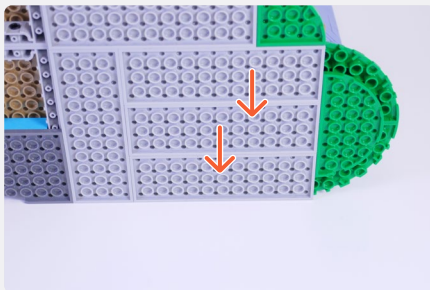
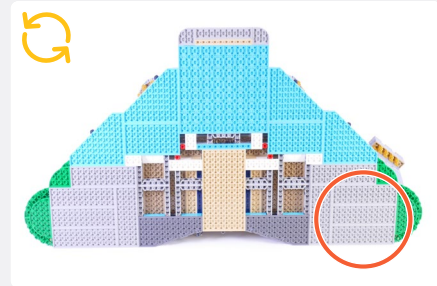

NOTE

Use the Brick Separator from the LEGO set to push the 2x4 Tile out from underneath.

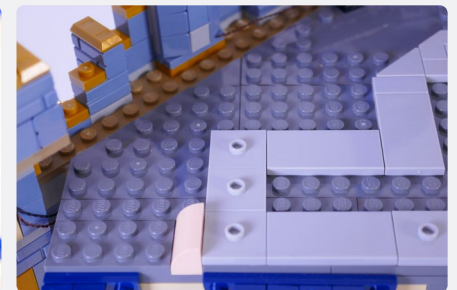
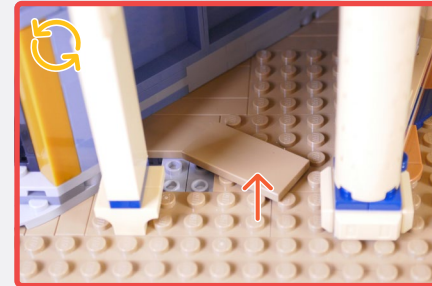
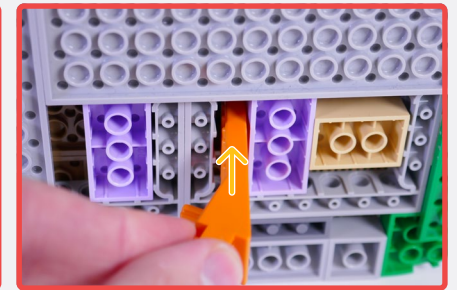
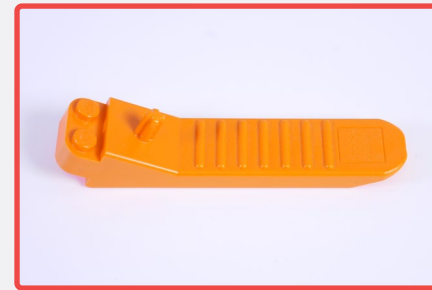

Wireless Power Connector Tile

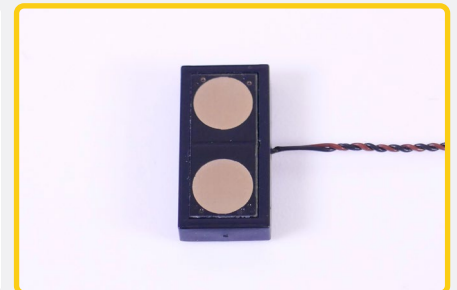

49

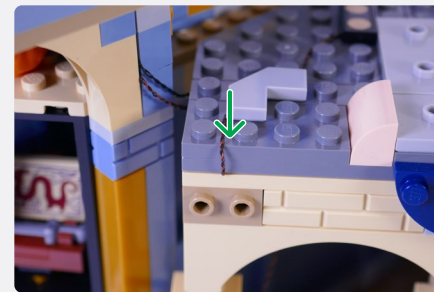
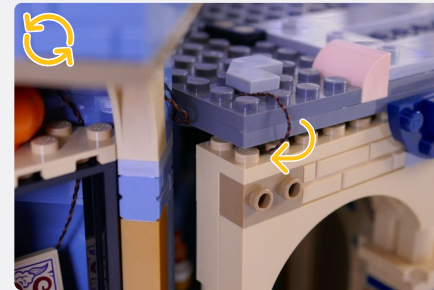
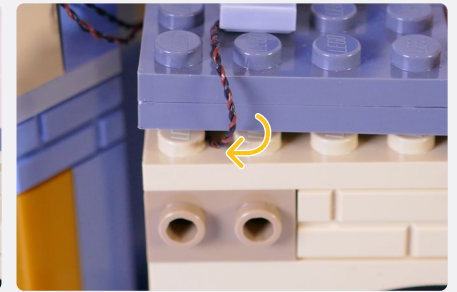
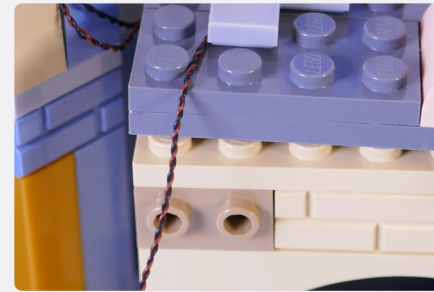
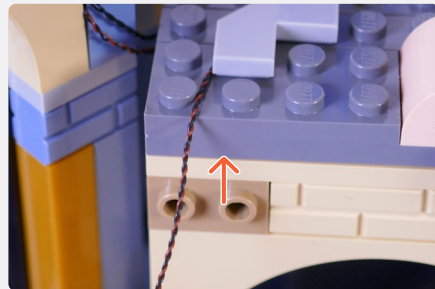
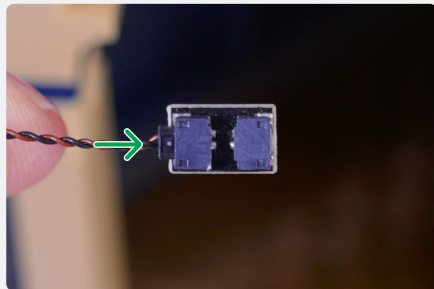
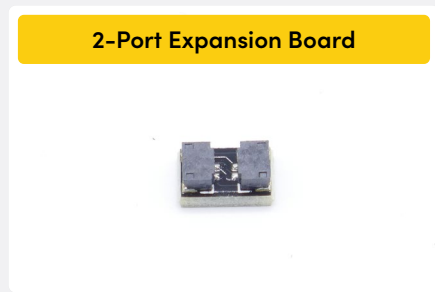
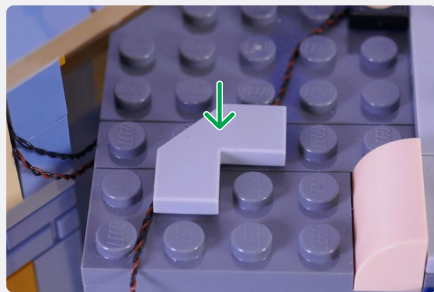
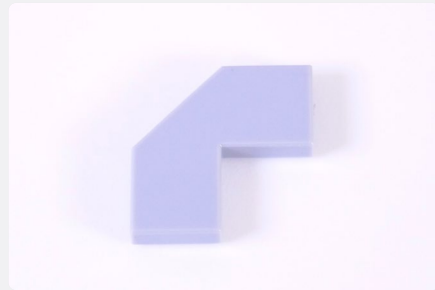
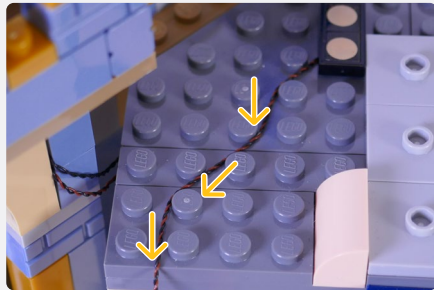
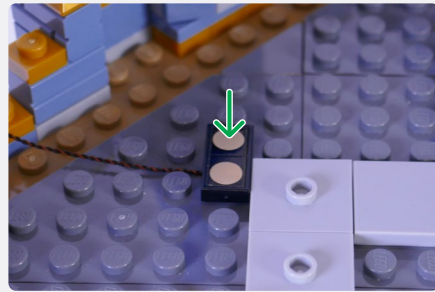
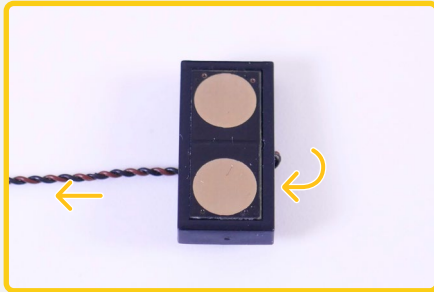

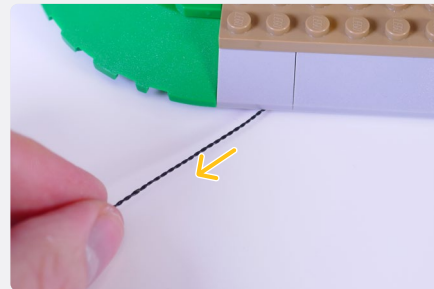
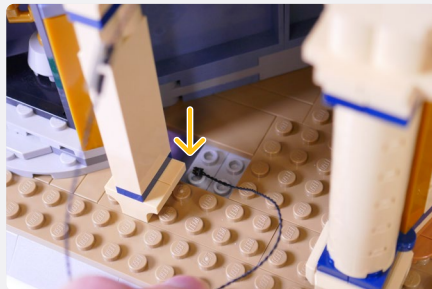
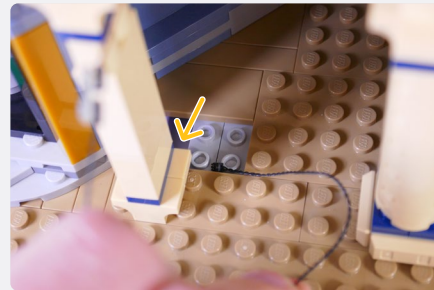
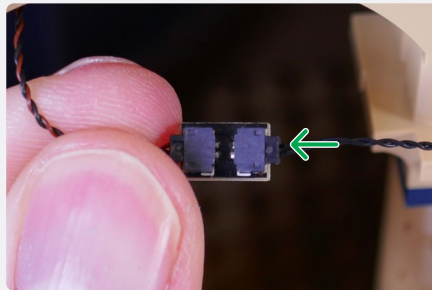

NOTE

Pull the cable, leaving some slack before pinning it down with the 2x4 Tile.

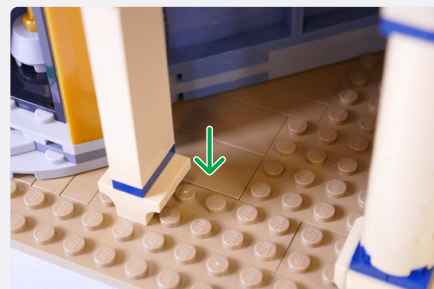
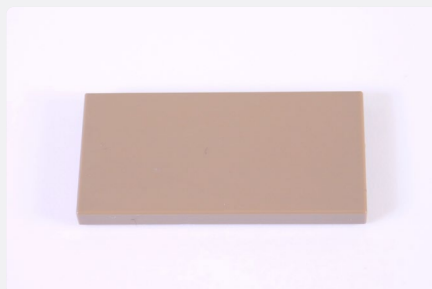
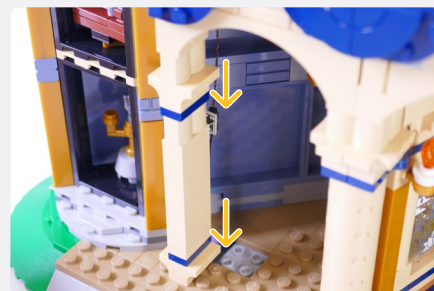

50

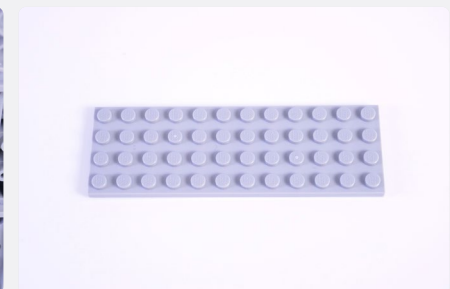
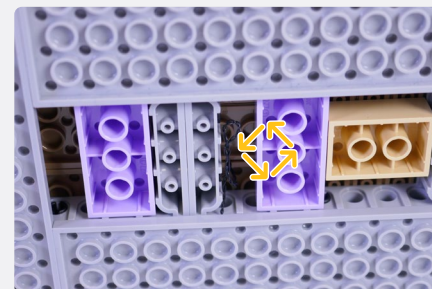
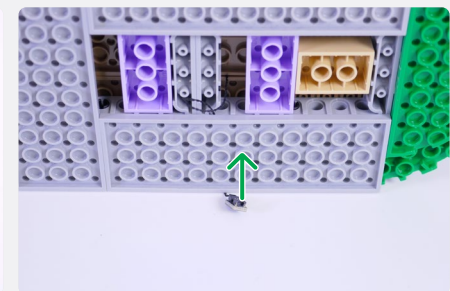
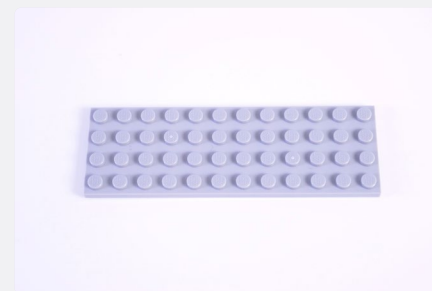
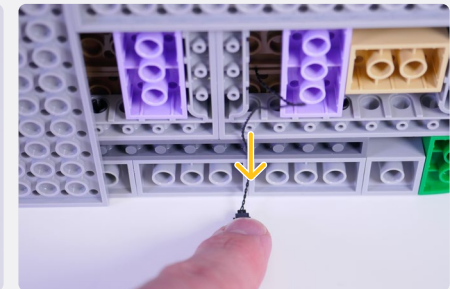
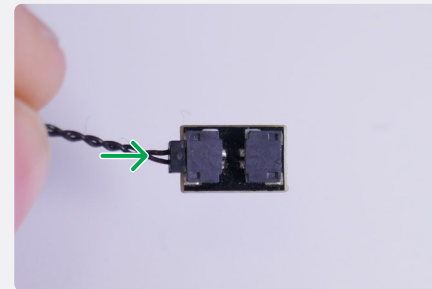
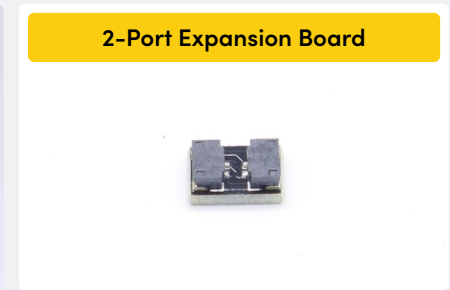
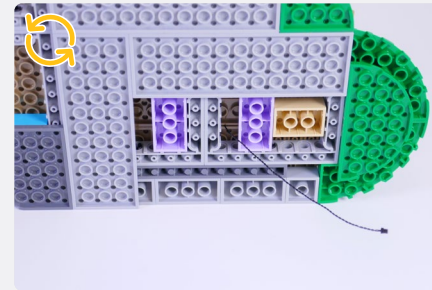

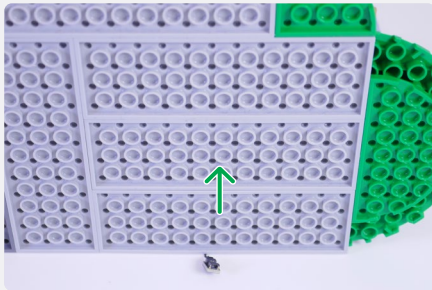

USB Power Cable



51

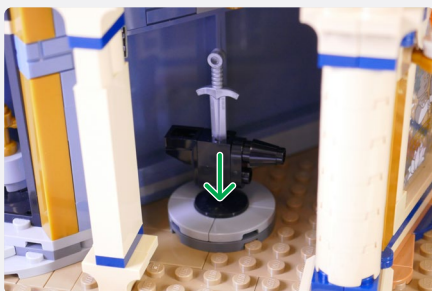
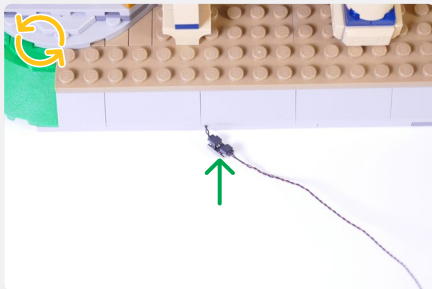
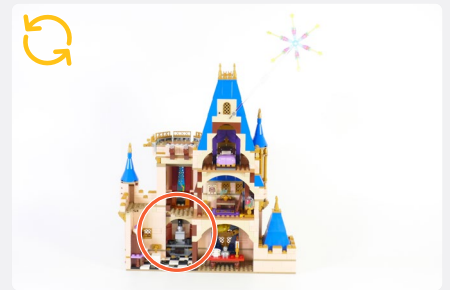

NOTE

Connect a USB Power Bank to the left USB Power Cable to power the castle without the fireworks. Connect another USB Power Bank to the other USB Power Cable to power the fireworks.

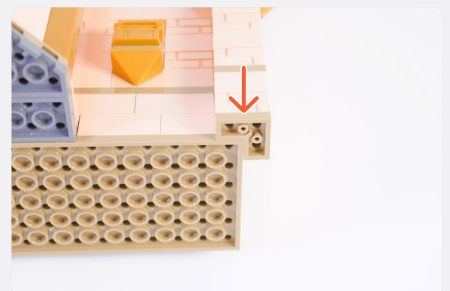
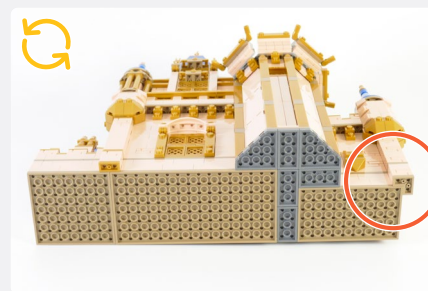

Wireless Power Connector Plate



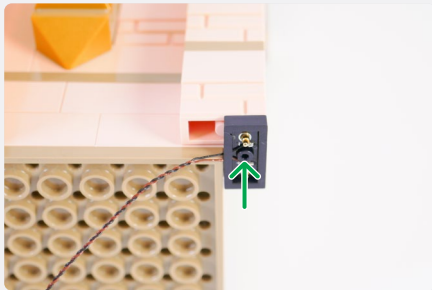

 **NOTE**

Remove wall section by pulling floor down then pulling wall section down.

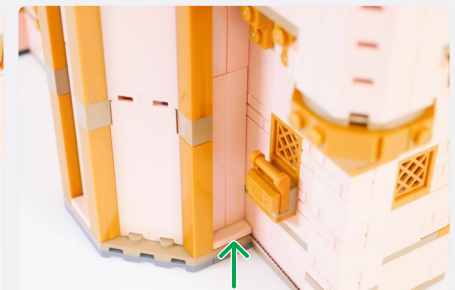
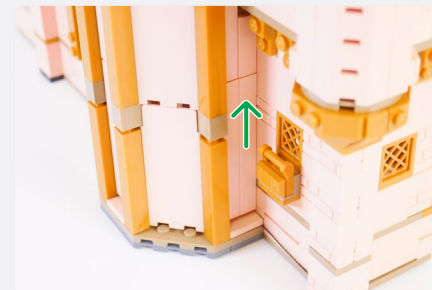
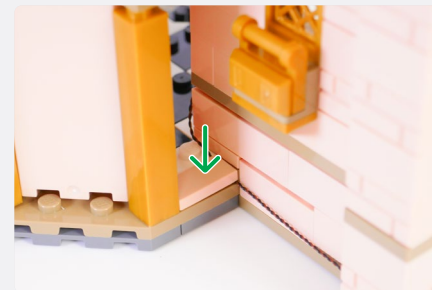
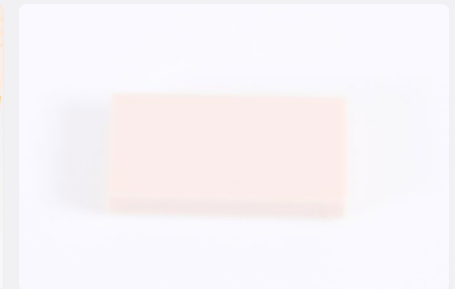
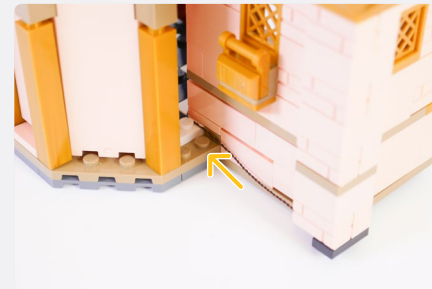
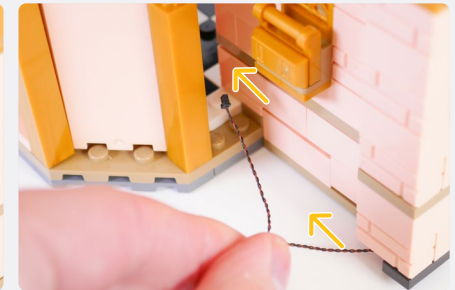
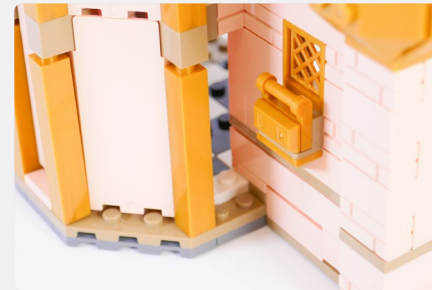
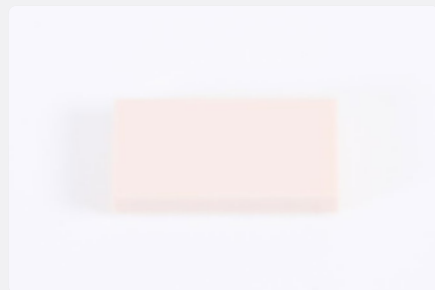
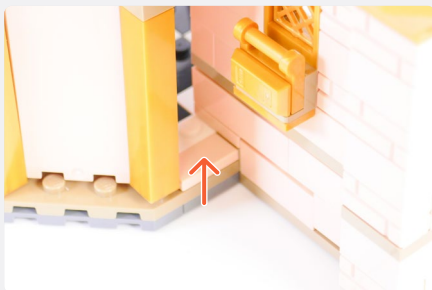
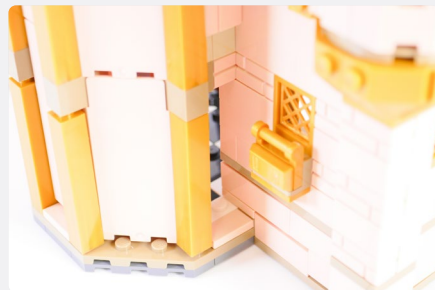
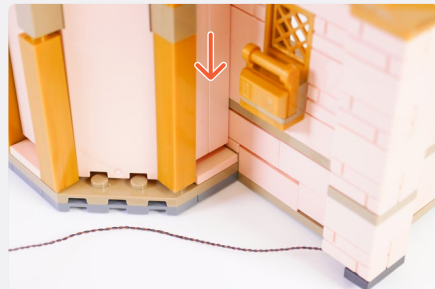
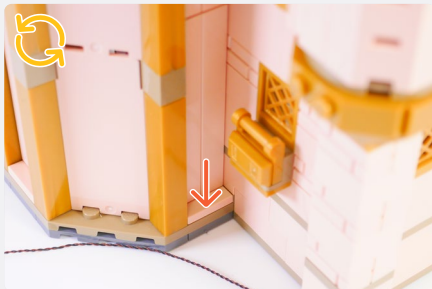

52

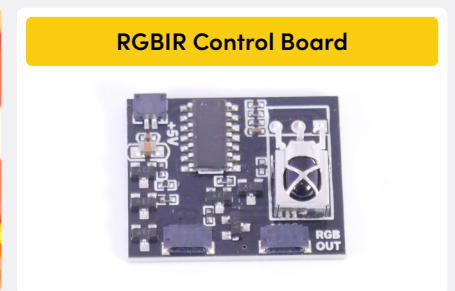
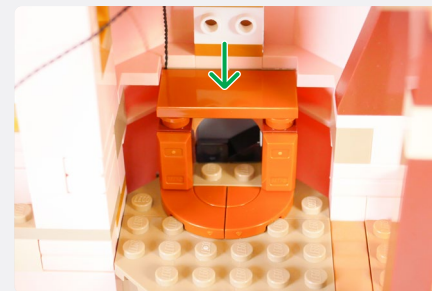
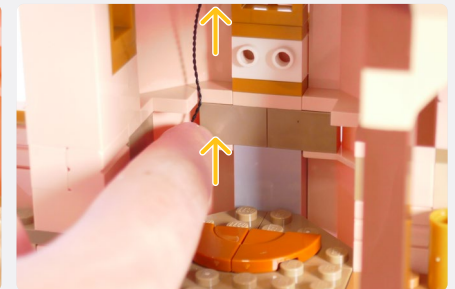
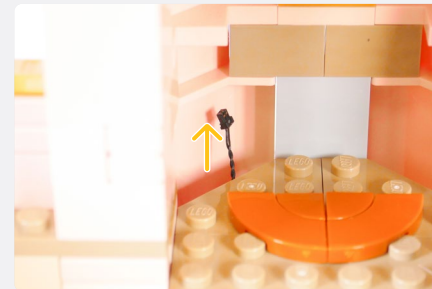
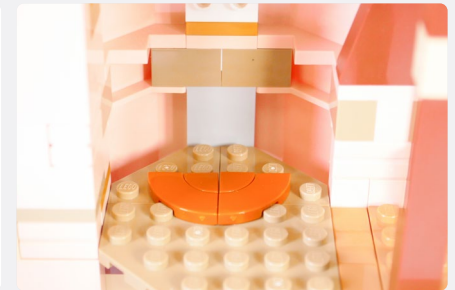
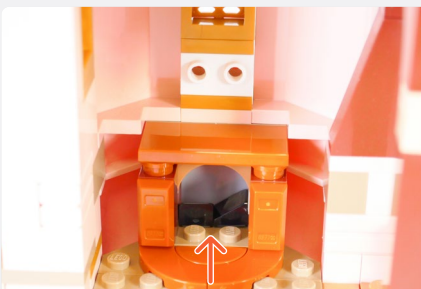
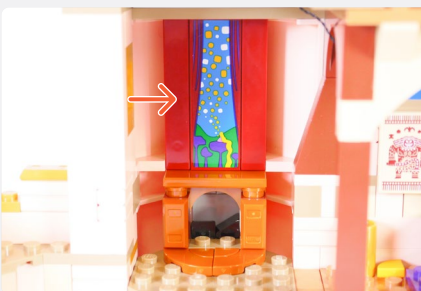
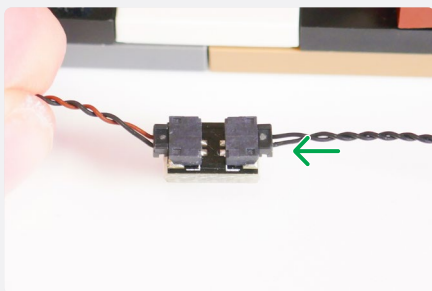
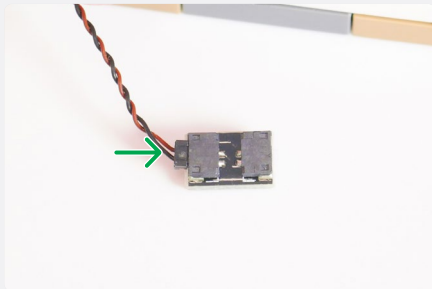
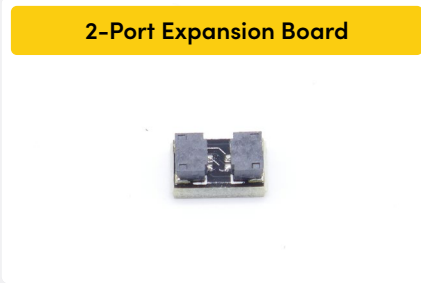

NOTE

Connect the 15cm Connecting Cable to the "+5V" port of the RGB IR Control Board. This will be used in later for the Fireworks.

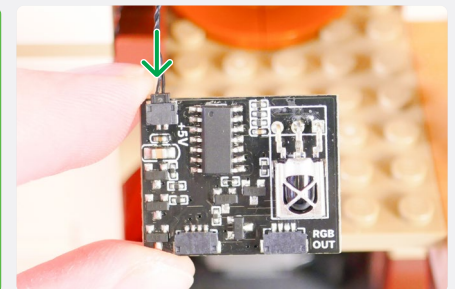

53

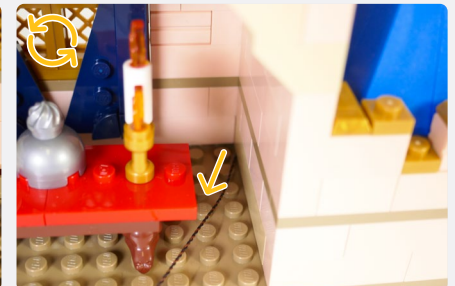
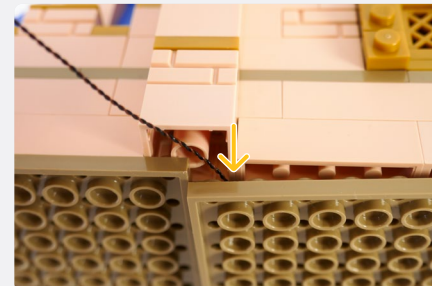
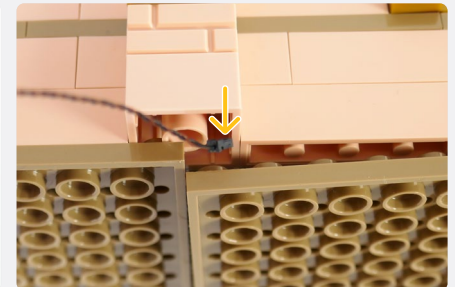
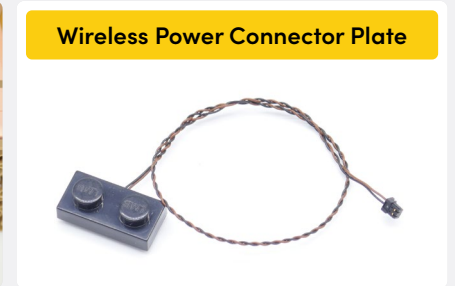
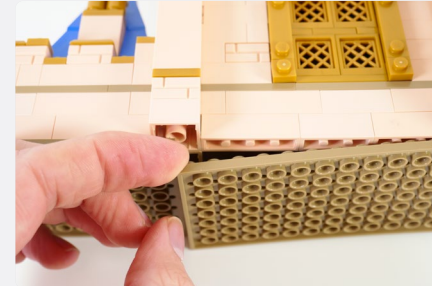
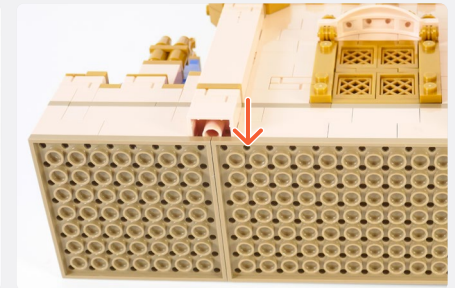
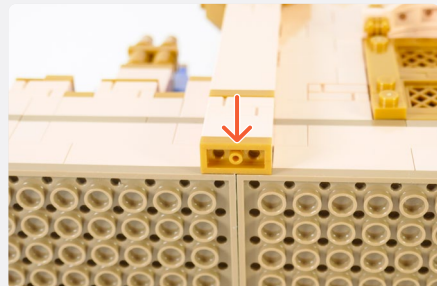
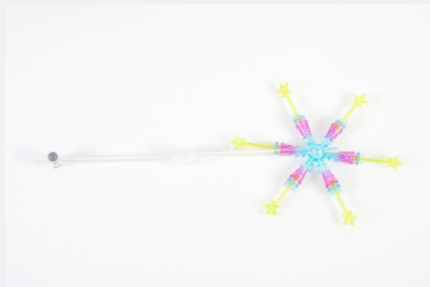

54

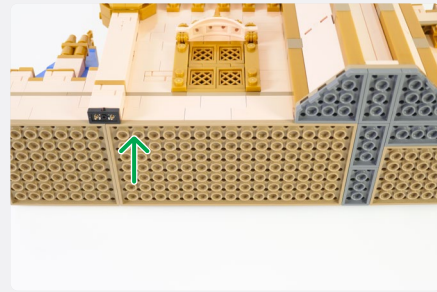
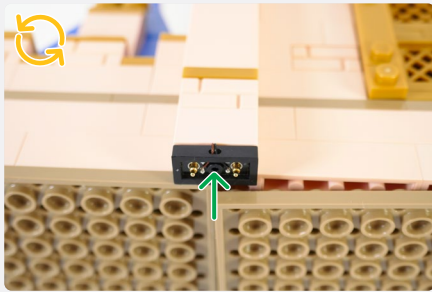



NOTE

Pull Wireless Connecting Cable from Step 53 up through the floor.



8-Port Expansion Board

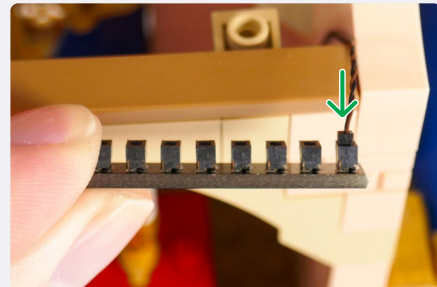

55

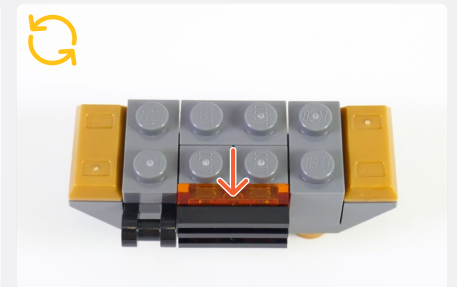
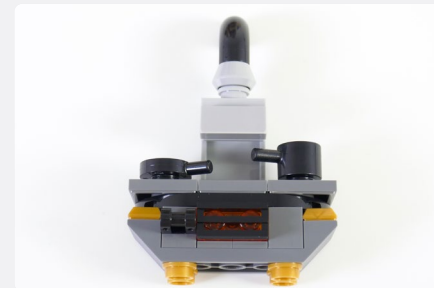
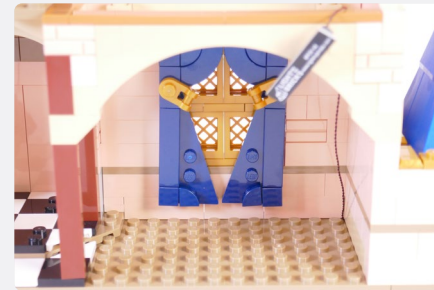

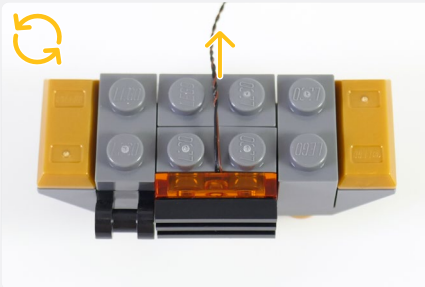
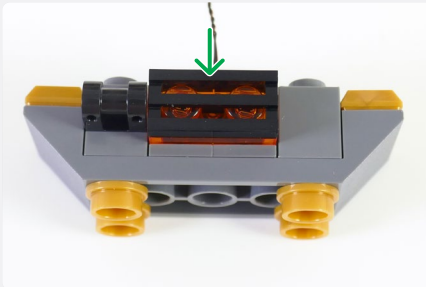
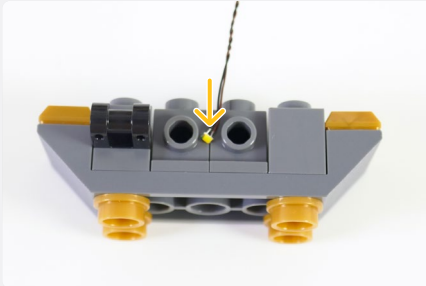
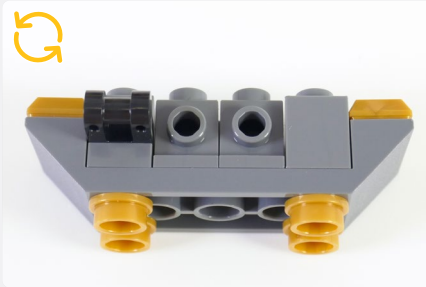

56

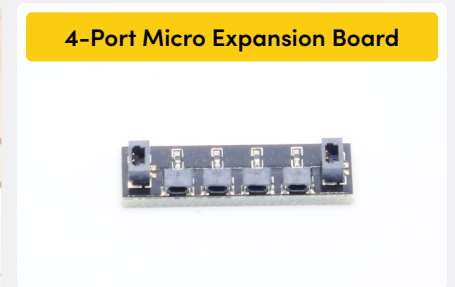
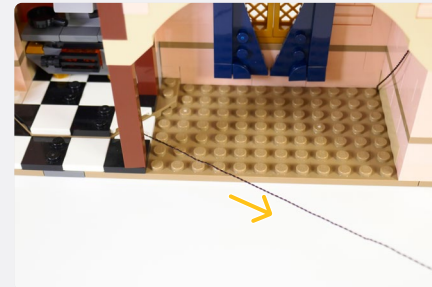
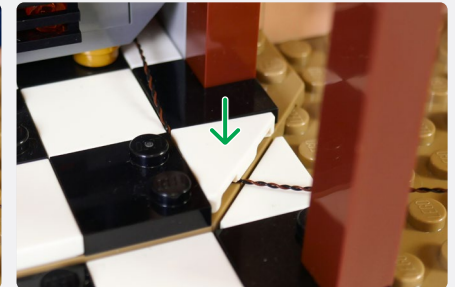
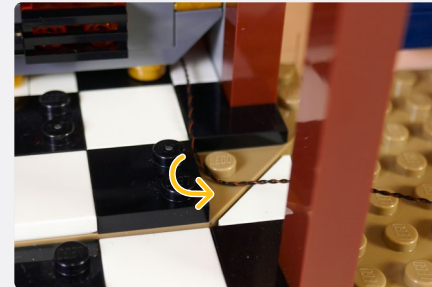
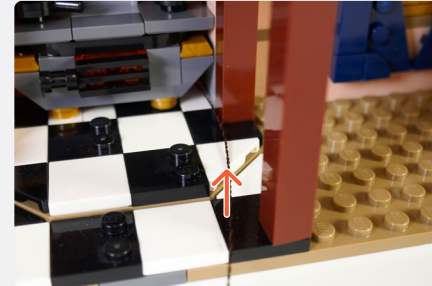
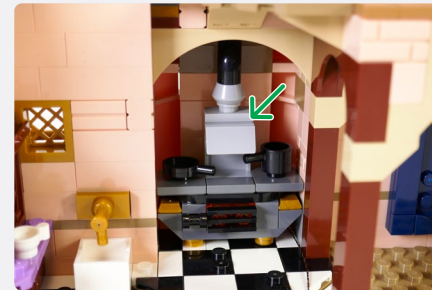

57

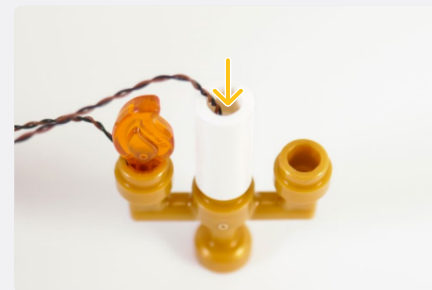
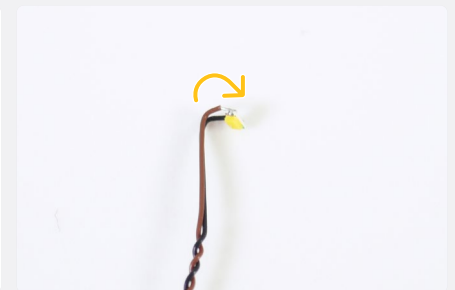
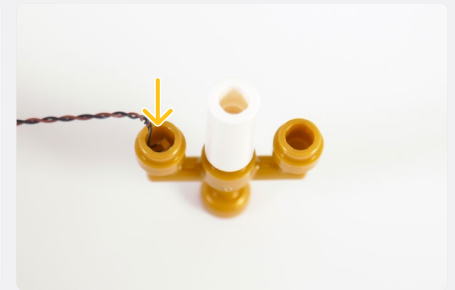
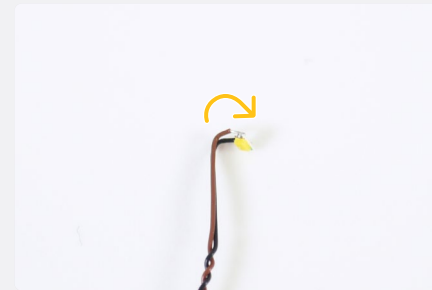
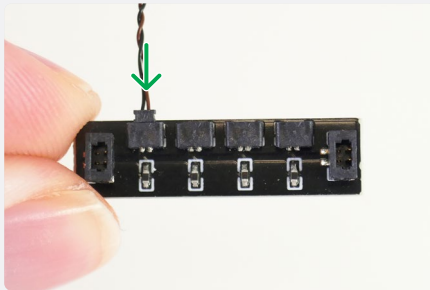



White 15cm Micro Bit Light



58

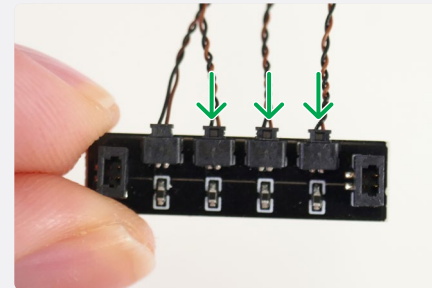
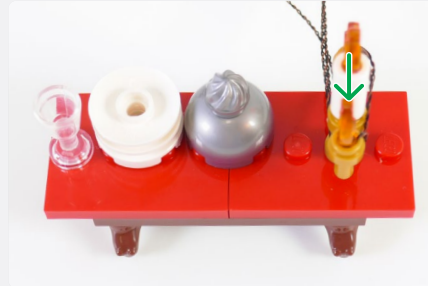
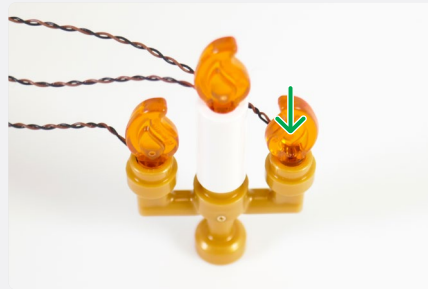
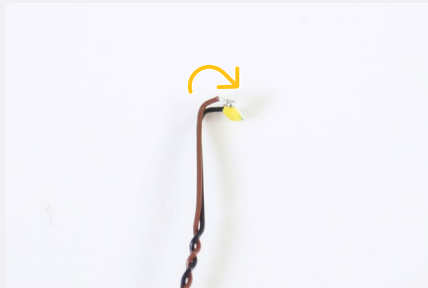

30cm Connecting Cable

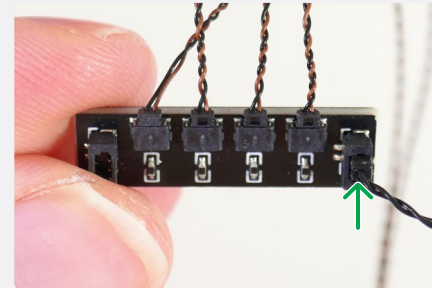

Flicker Effects Board



NOTE

Connect the 30cm Connecting Cable to any "OUT" port on the Flicker Effects Board then pull only the effects board to the next floor.

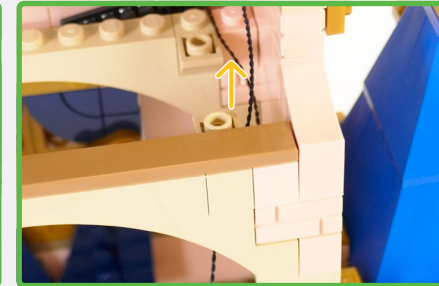
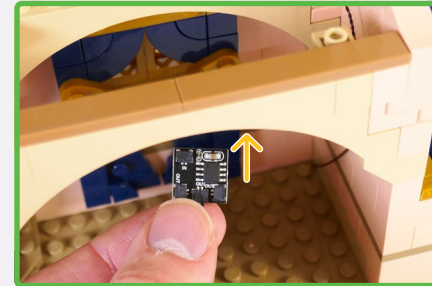
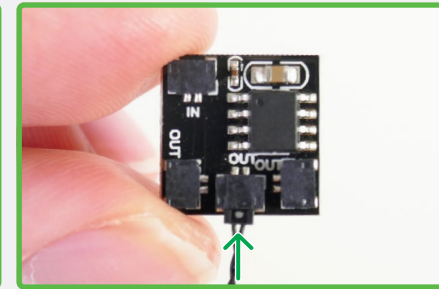

5cm Connecting Cable



NOTE

Connect the 5cm Connecting Cable to the "IN" port of the Flicker Effects Board then to the 8-Port Expansion Board.

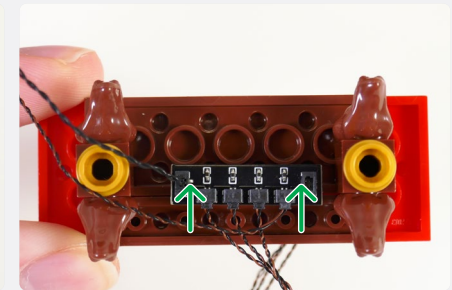
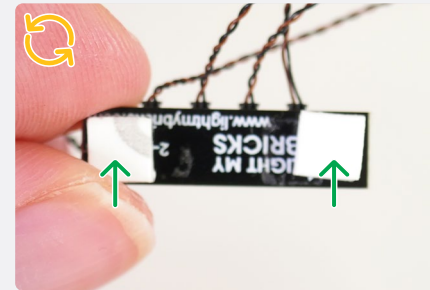
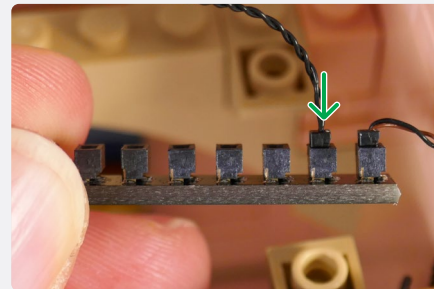
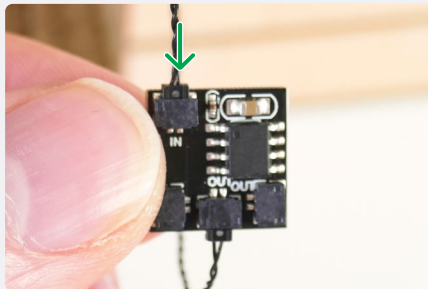

NOTE

Exclude the Connecting Cable when twisting the cables together.

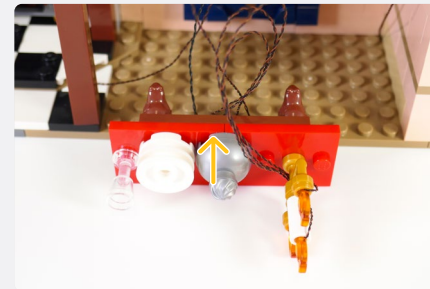

59

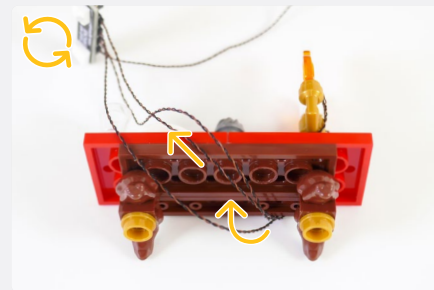

2x Adhesive Square



60



NOTE

Use the Oar piece included in the LEGO set to push the 2x2 Dish out through one of the 4 small holes in the Trans-Yellow piece.



White 15cm Bit Light

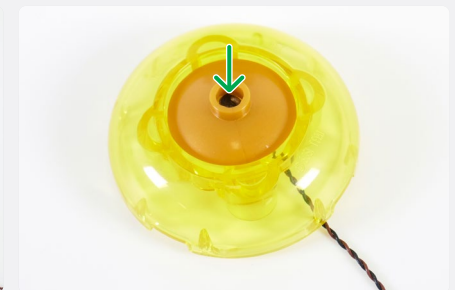
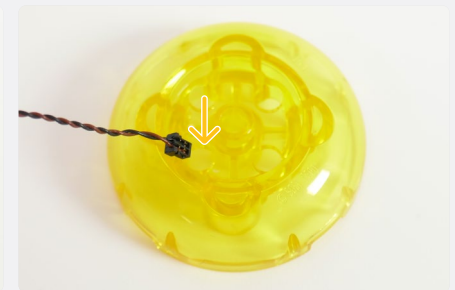
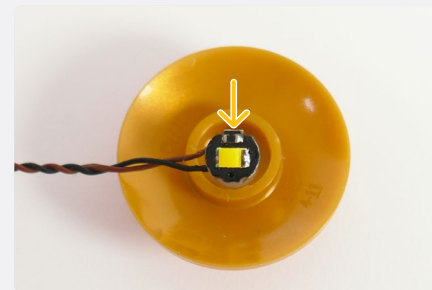

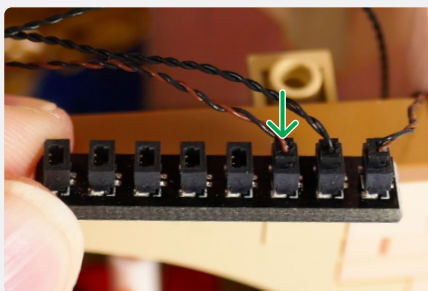
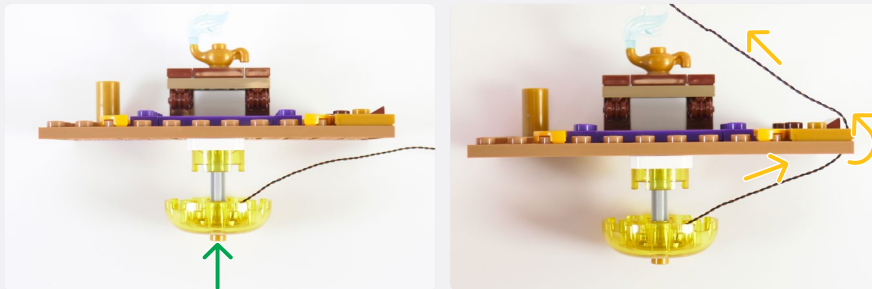
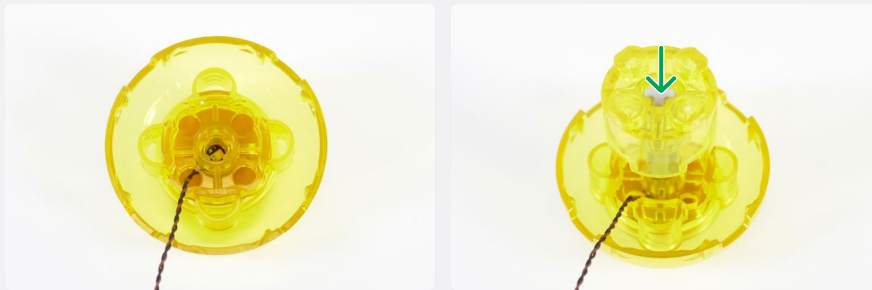

NOTE

Place the floor piece in place ensuring the 8-Port Expansion Board and Flicker Effects Board are pulled through.

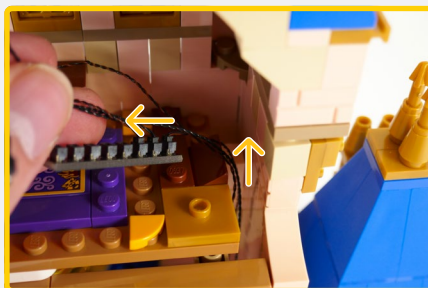

61



NOTE

When reconnecting the sections, ensure the Wireless Power Connectors are aligned, touching and orientated in the same direction.

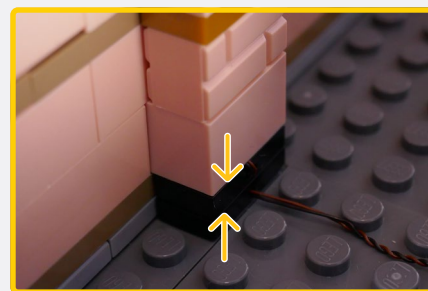
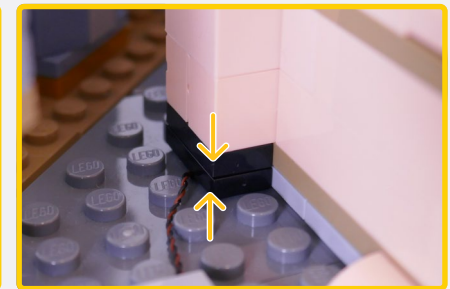

62



Plate, Round 1x1 with Open Stud - Pearl Gold



Blue 15cm Micro Bit Light

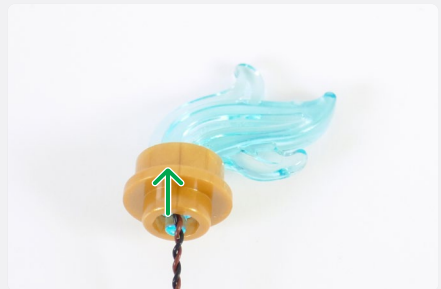
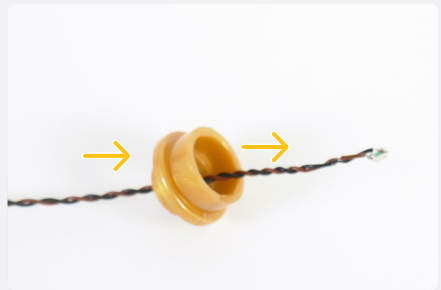

4-Port Micro Expansion Board

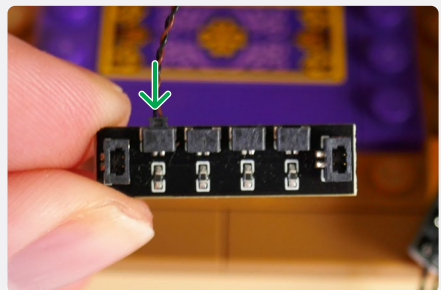
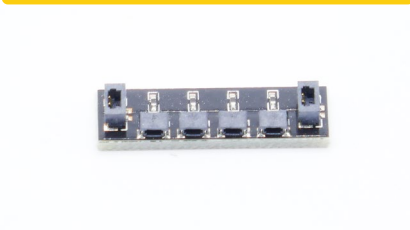

5cm Connecting Cable

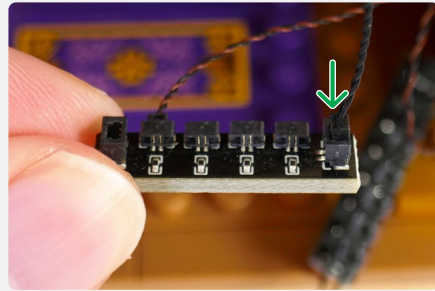

NOTE

Connect the other end of the 5cm Connecting Cable to the 8-Port Expansion Board.

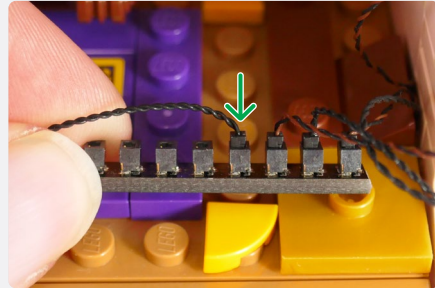

63

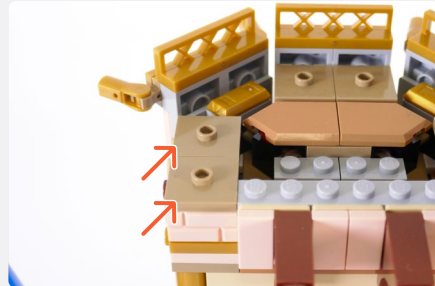
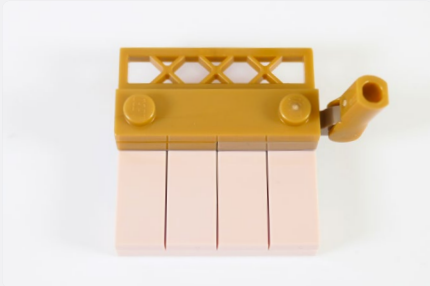
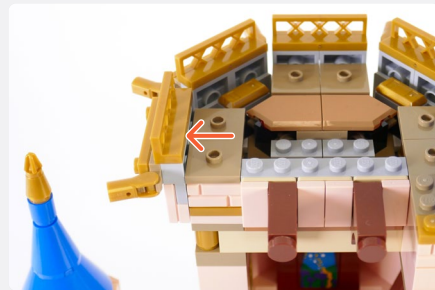
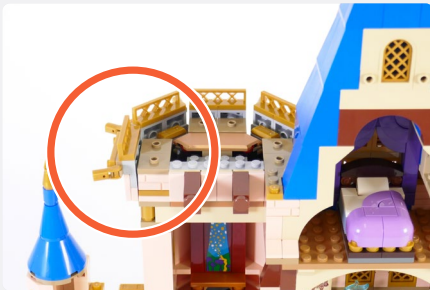

64

12-Port Expansion Board

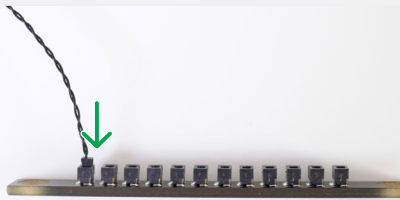

30cm Connecting Cable

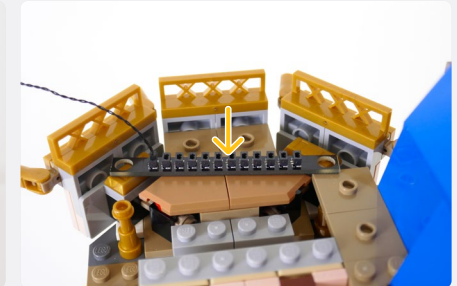

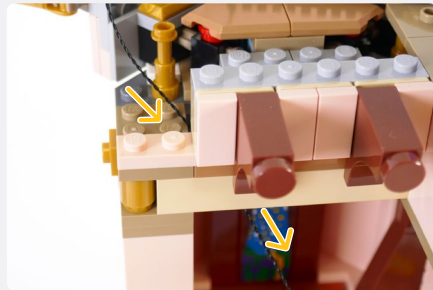
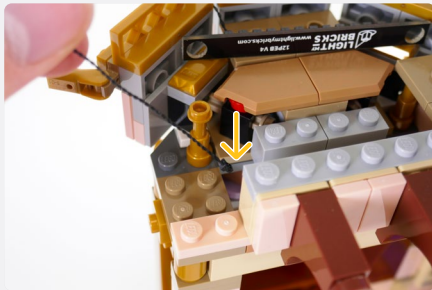

NOTE

Connect the other end of the 30cm Connecting Cable to the 8-Port Expansion Board.

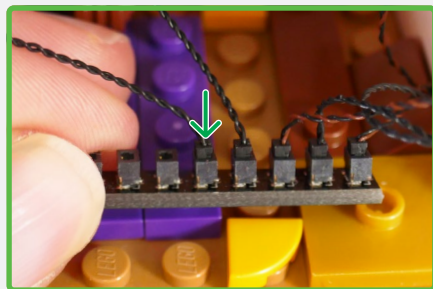

White 15cm Bit Light

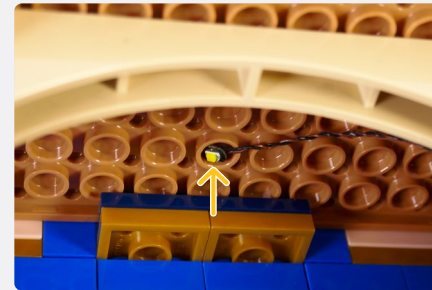

NOTE

Thread the 30cm Connecting Cable from the previous Step along the roof next to the White 15cm Bit Light.

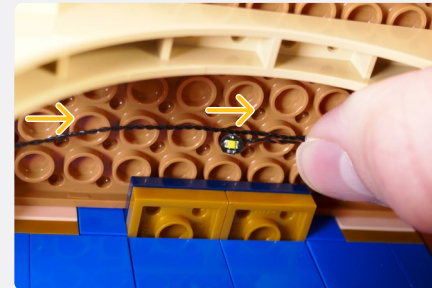

Plate, Round 2x2 with Rounded Bottom (Boat Stud) - Trans-Clear

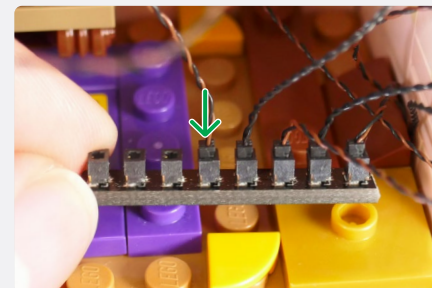
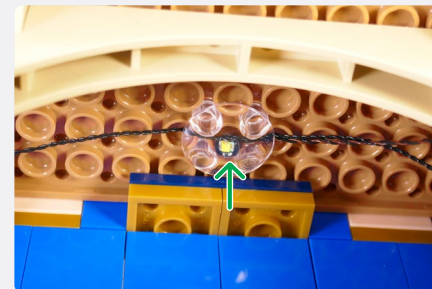

Pink 30cm Bit Light

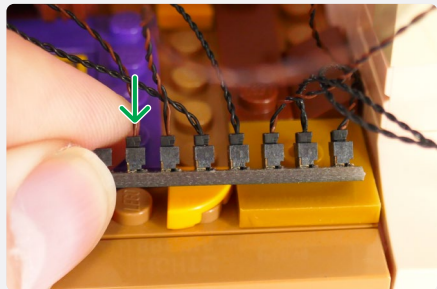
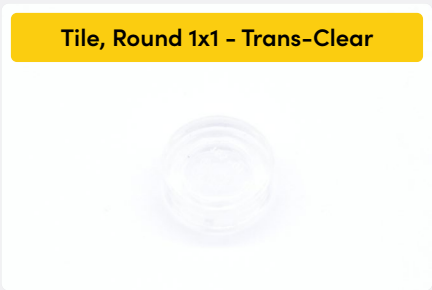

66

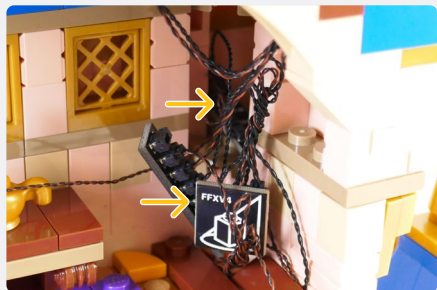
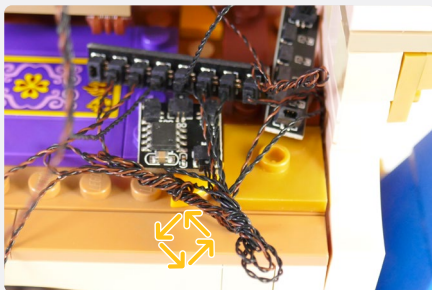

67

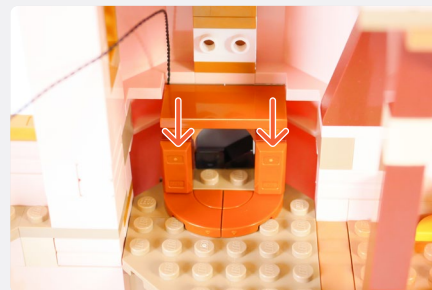

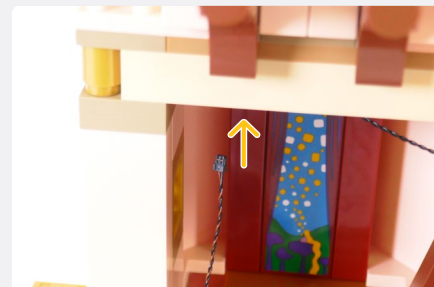
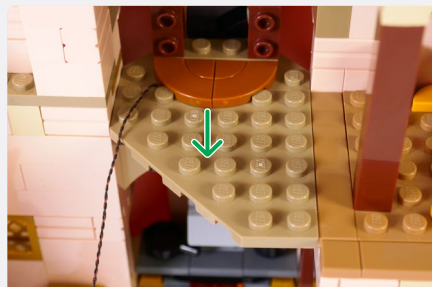
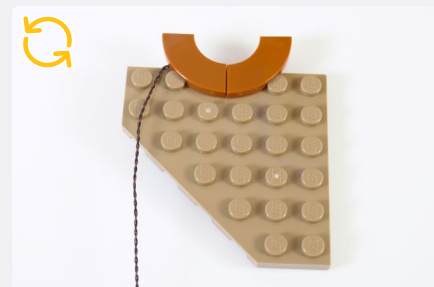
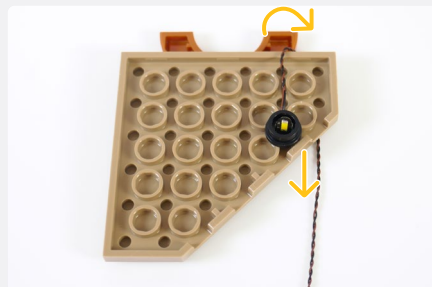
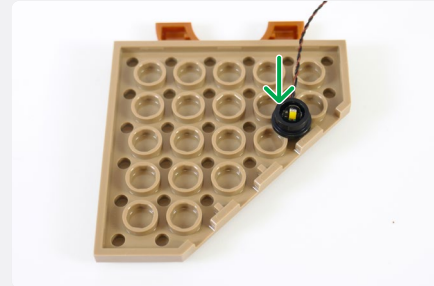
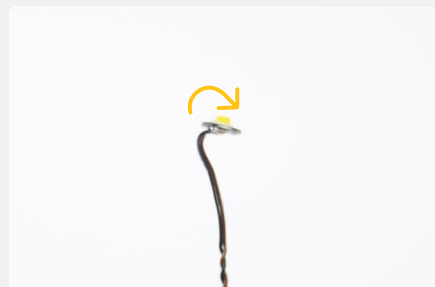

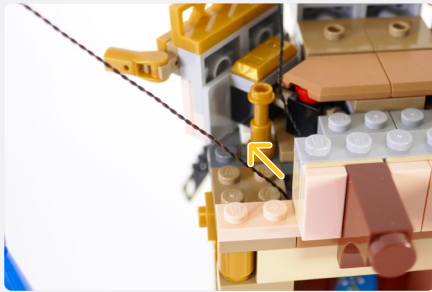

NOTE

Connect the Bit Light cable to the 12-Port Expansion Board.

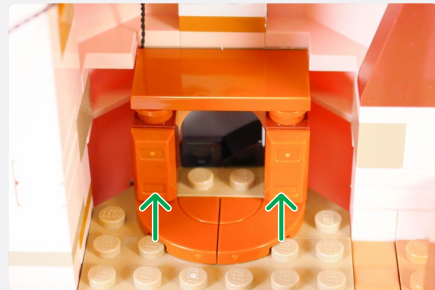
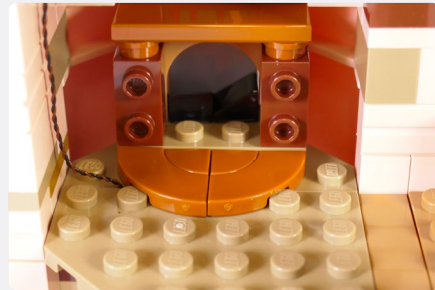
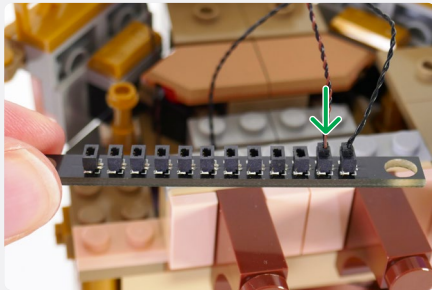

69



White 30cm Bit Light

Plate, Round 2x2 with Rounded Bottom (Boat Stud) - Trans-Clear

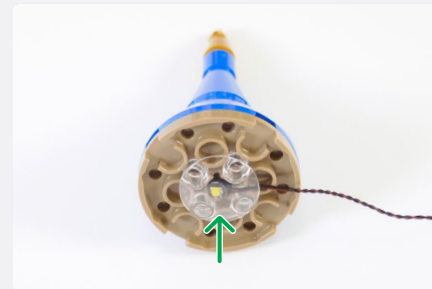
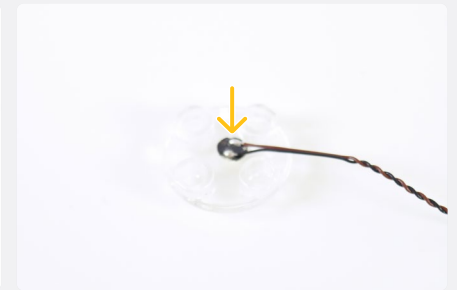

70

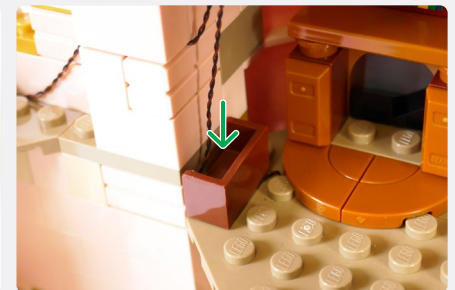
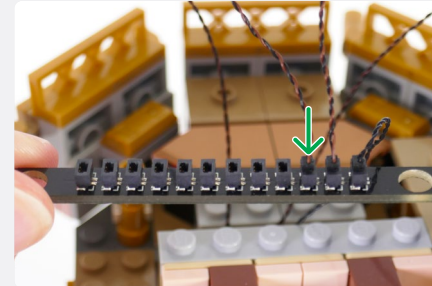
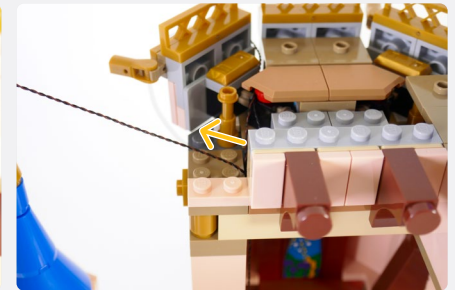
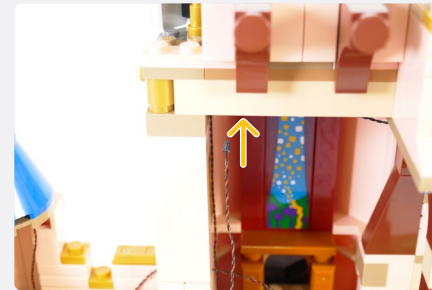
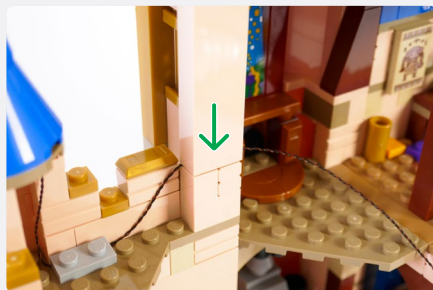
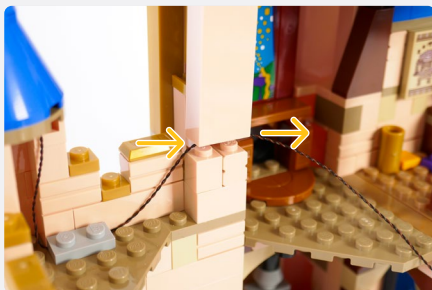
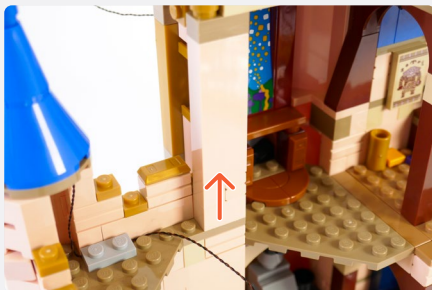
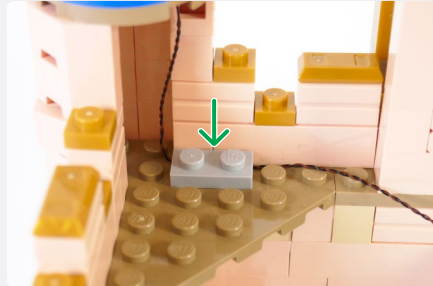
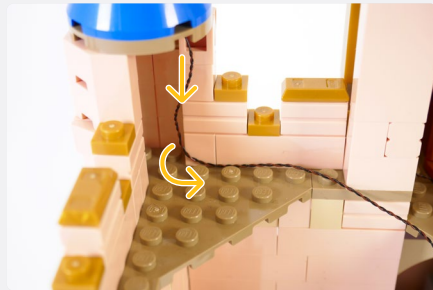
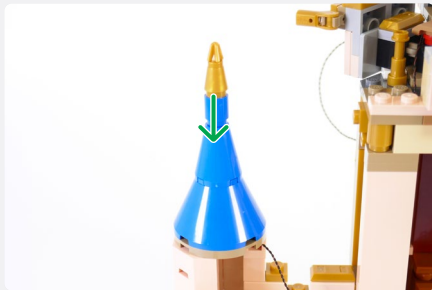

71



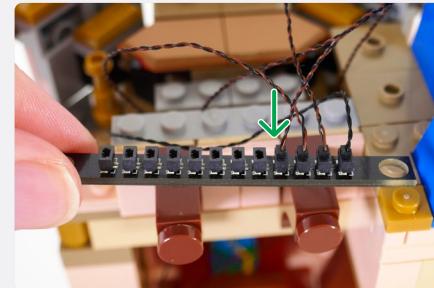
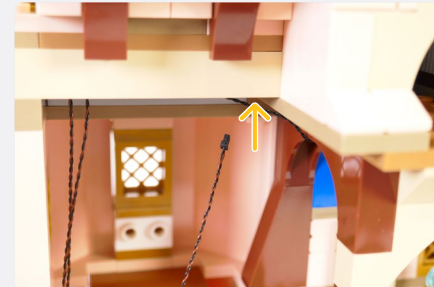
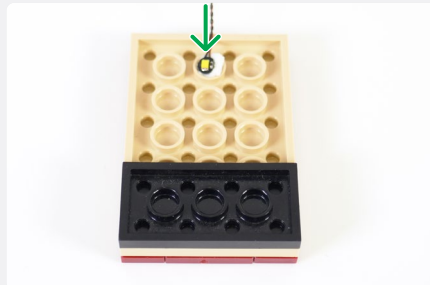
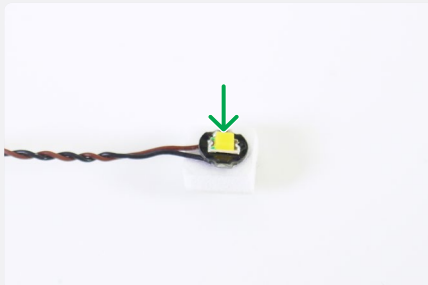
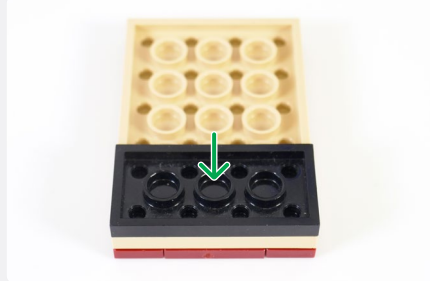

NOTE

Pull all the cables connected to the 12-Port Expansion Board firmly before using a Round Plate 1x1 to secure them in position.

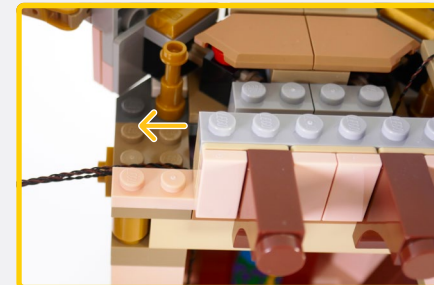

Plate, Round 1x1 with Open Stud - Black

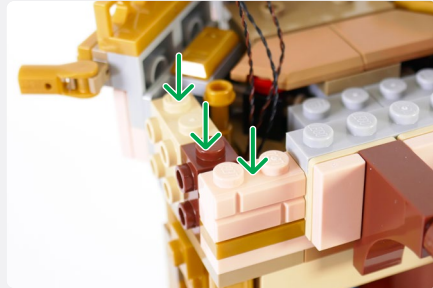
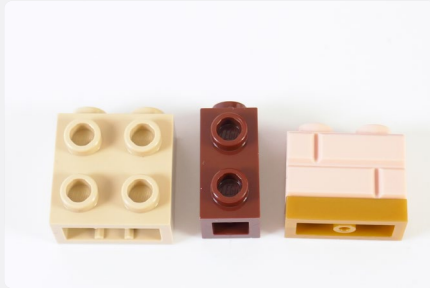
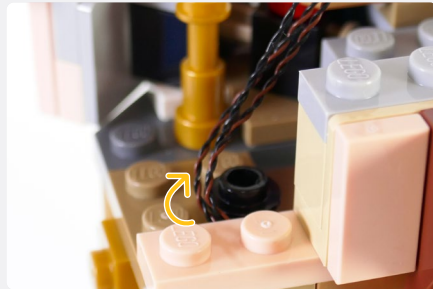
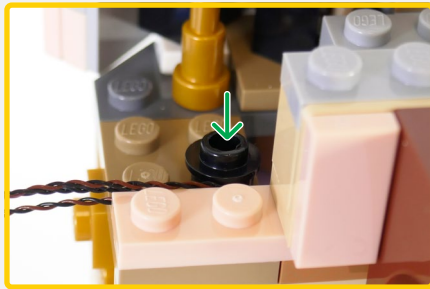

72

White 15cm Bit Light

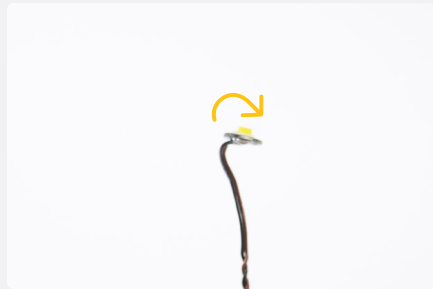

Plate, Round 1x1 with Open Stud - Black

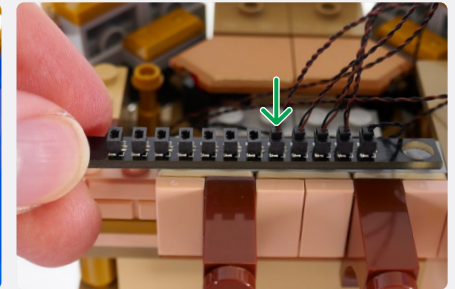
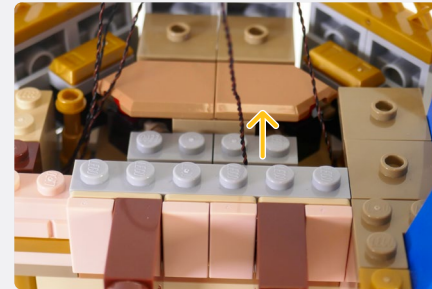
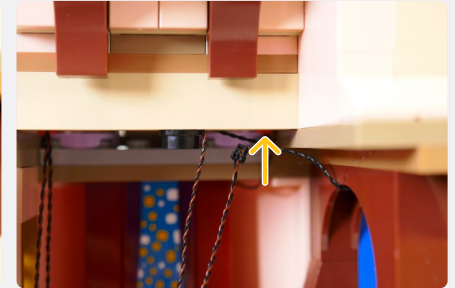
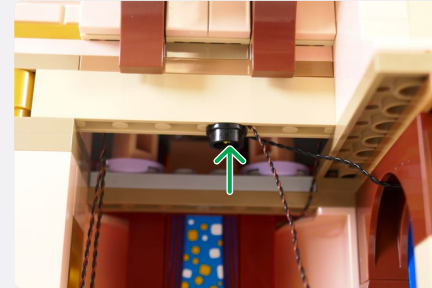

73



NOTE

When reconnecting the sections, ensure the Wireless Power Connectors are aligned, touching and orientated in the same direction.

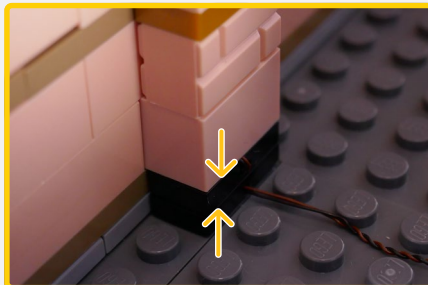
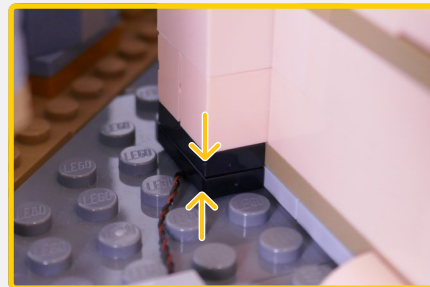

! If you experience any issues with the lights not working and suspect an issue with a component, please try a different port on the expansion board to verify where the fault lies (with the light or expansion board). To correct any issues with expansion board ports, please view the section addressing expansion board issues in our troubleshooting section. **i**

74

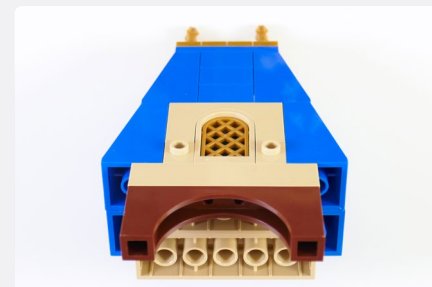

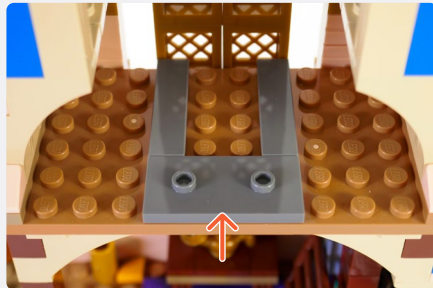
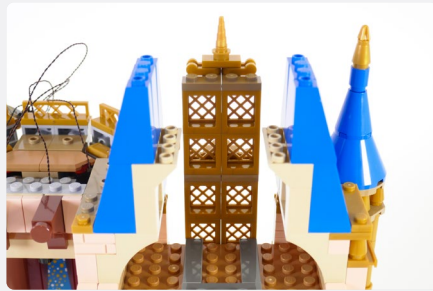
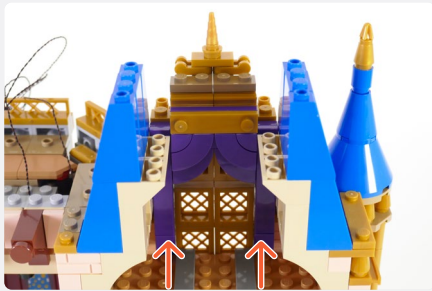
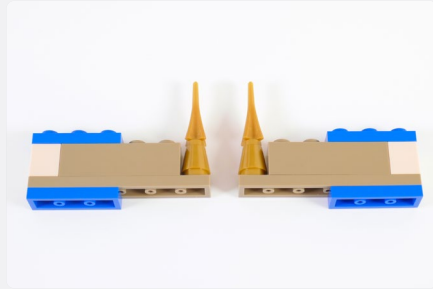
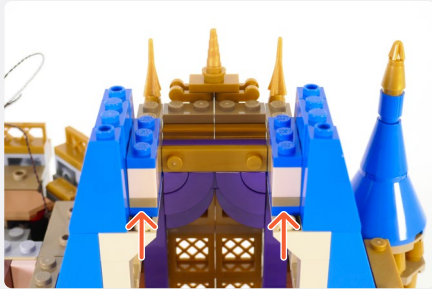
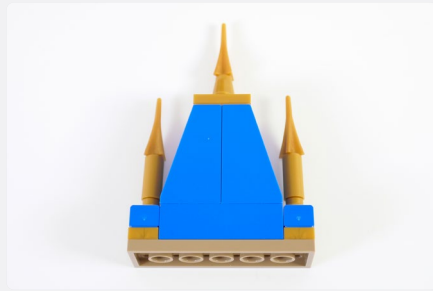

75

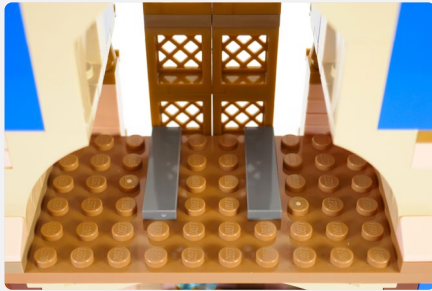

White 30cm Bit Light

Adhesive Square

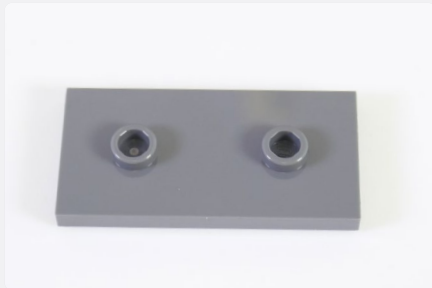
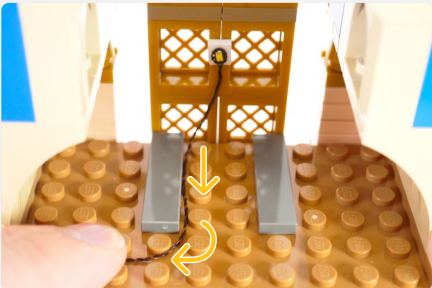
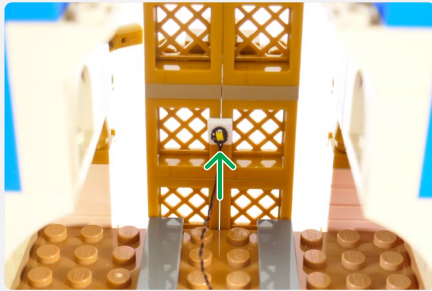

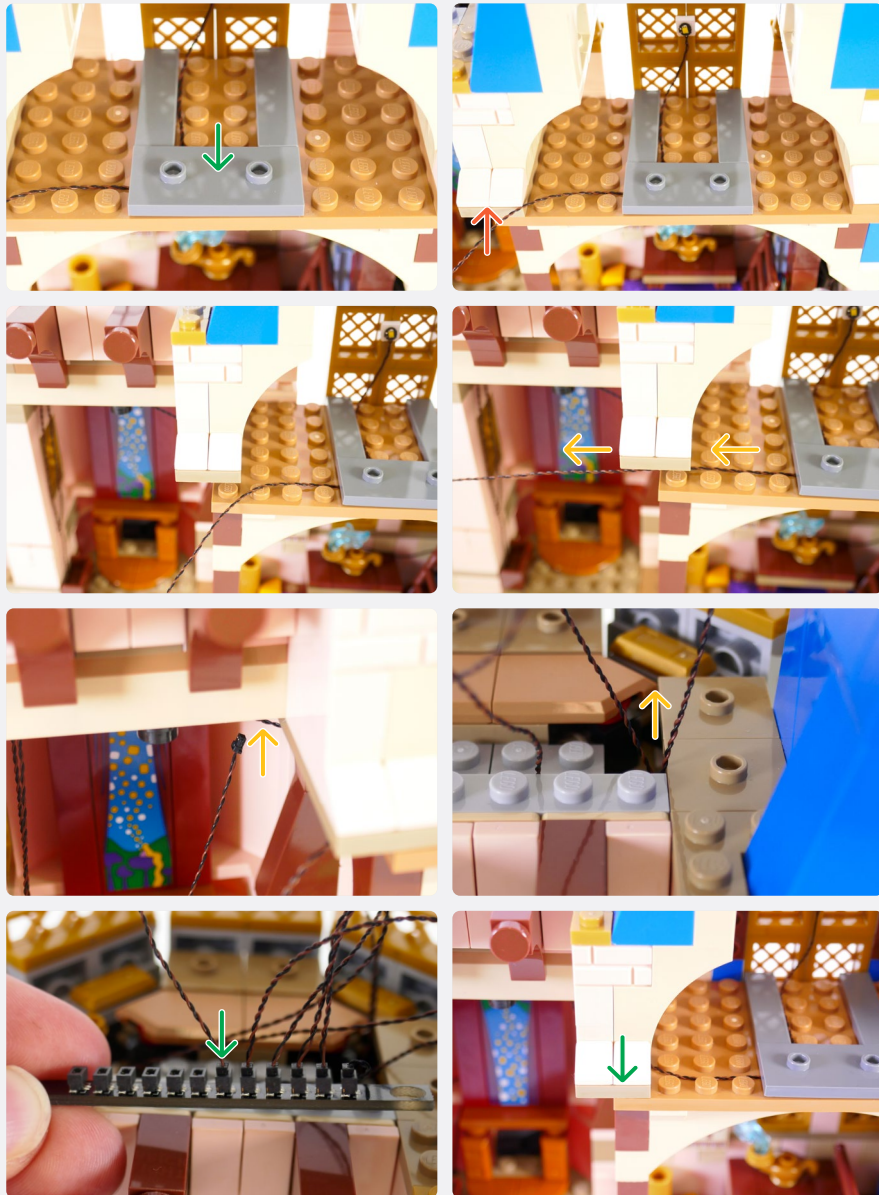

76

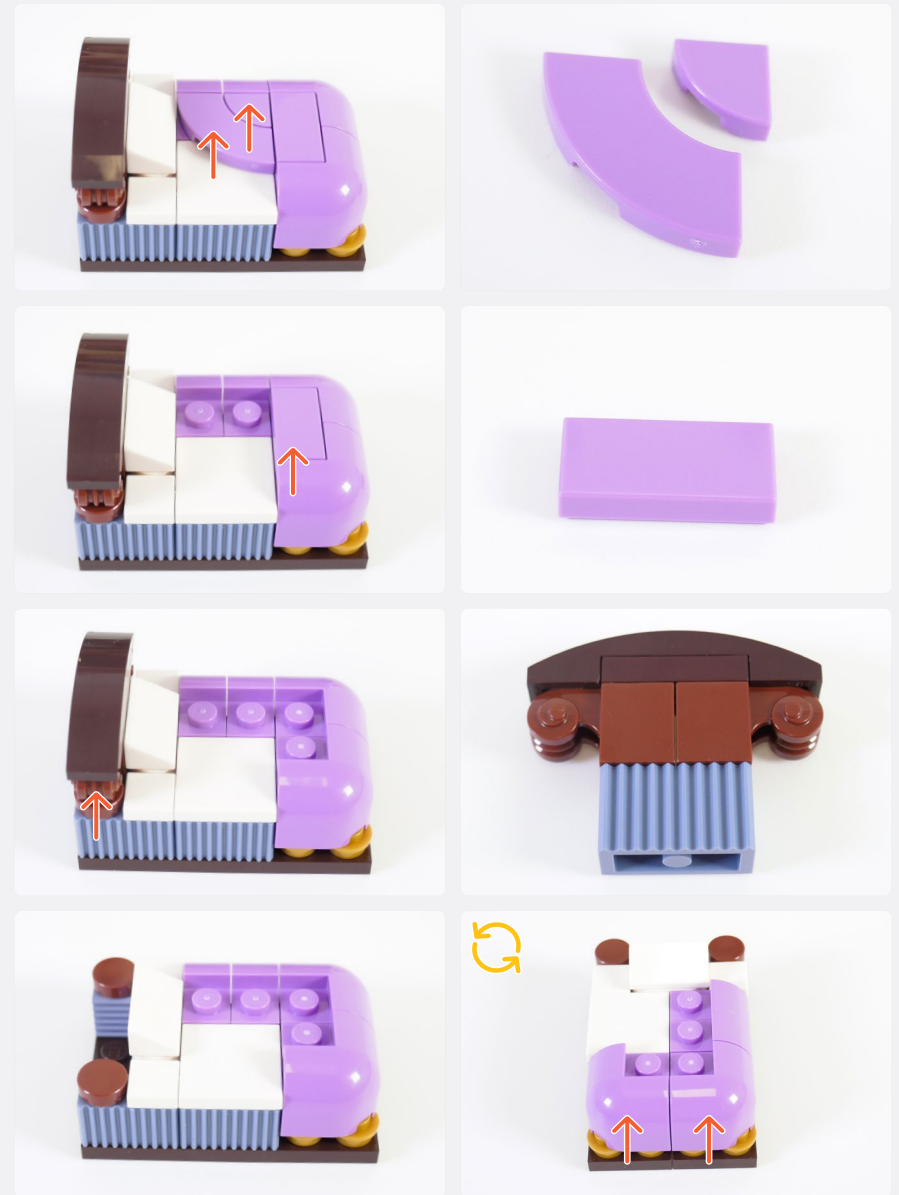

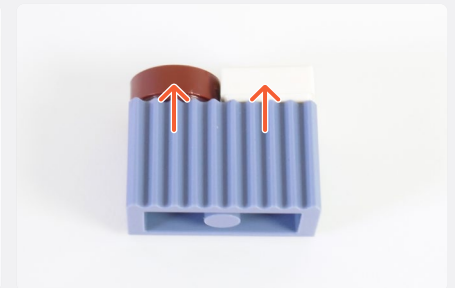
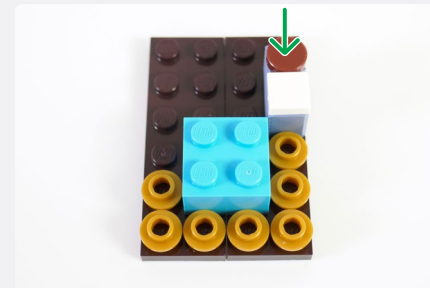
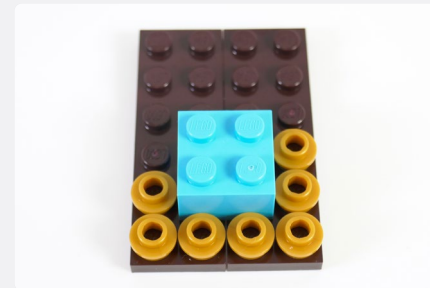
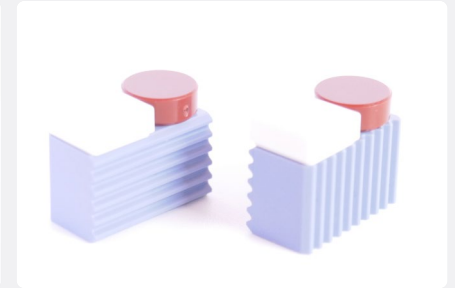
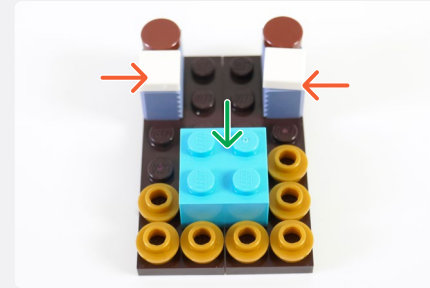
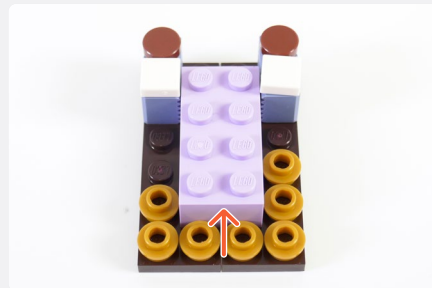
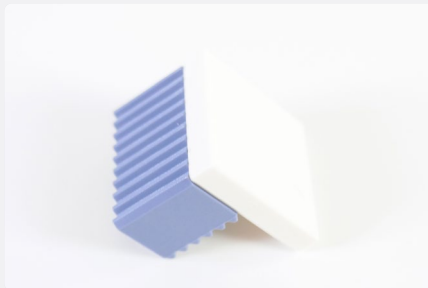
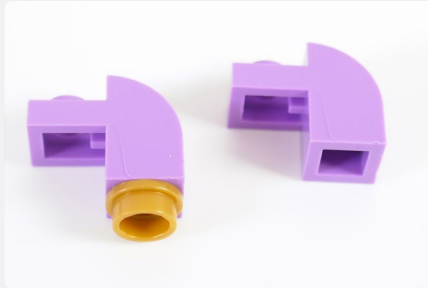
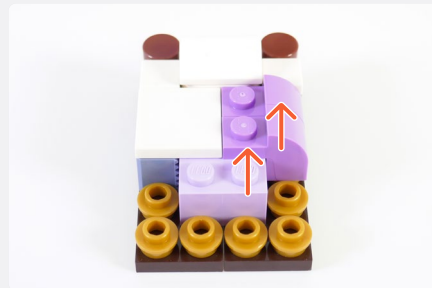

77

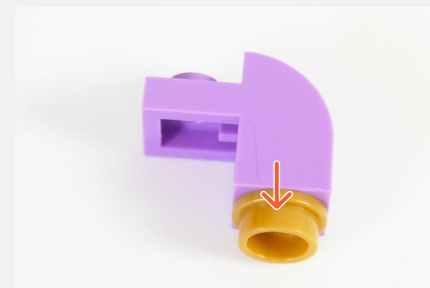
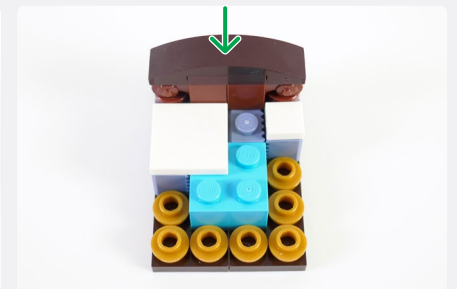
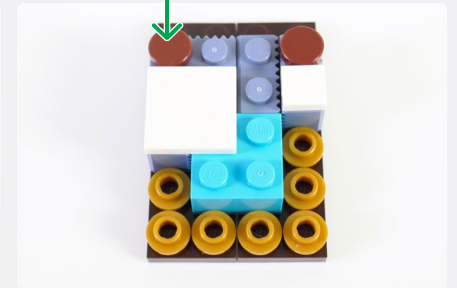
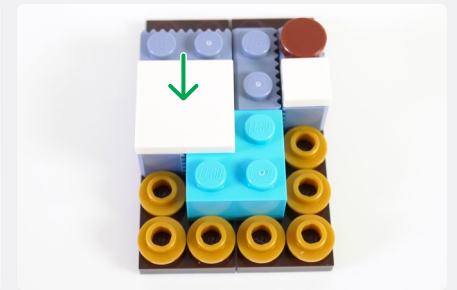
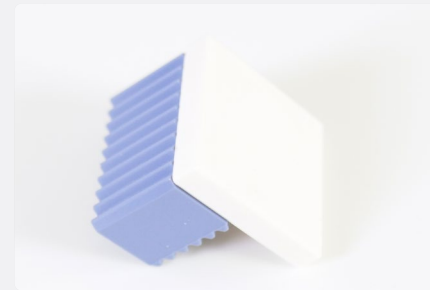
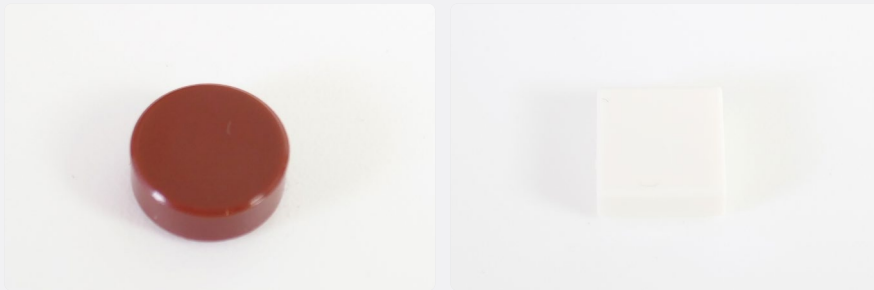

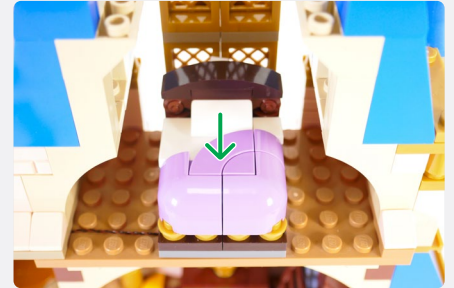
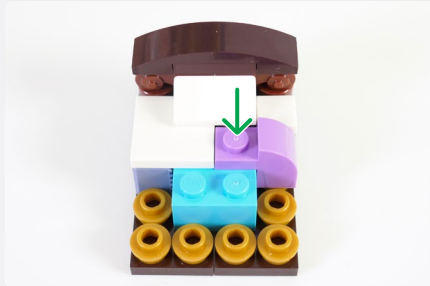
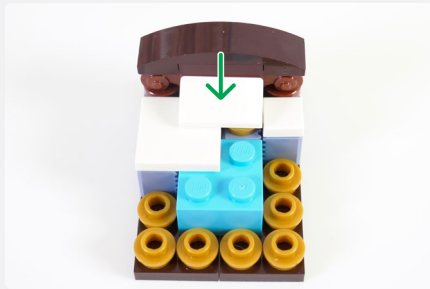
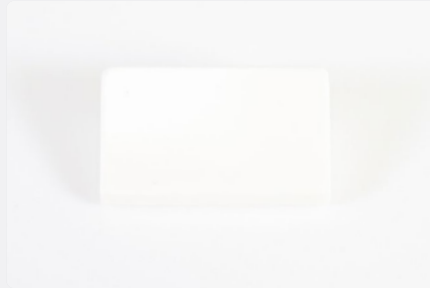

78

White 15cm Bit Light



Adhesive Square

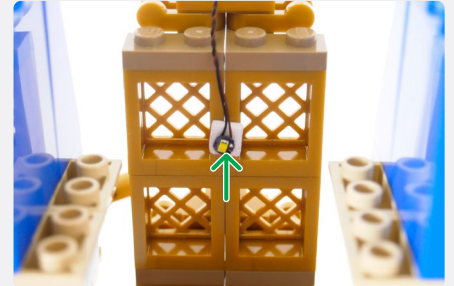
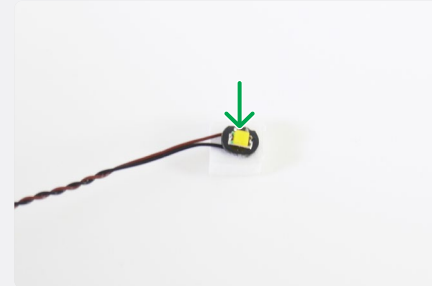

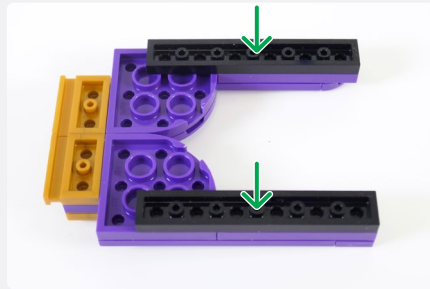
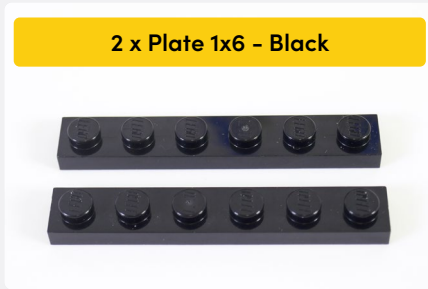
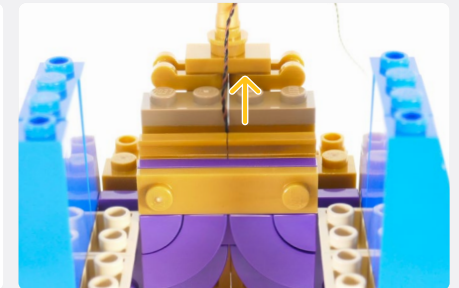
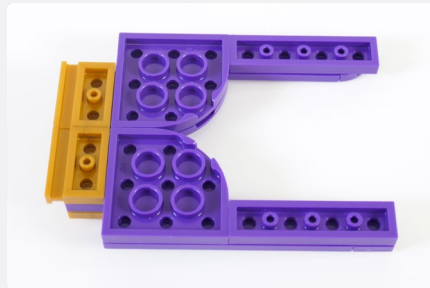
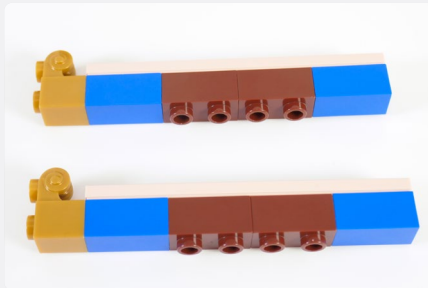
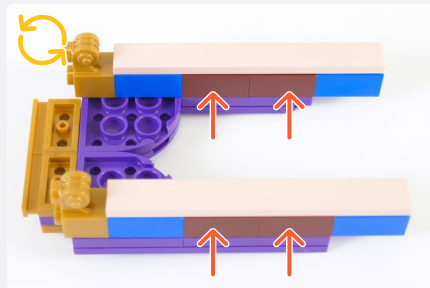

79

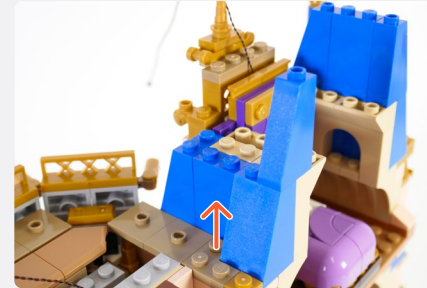
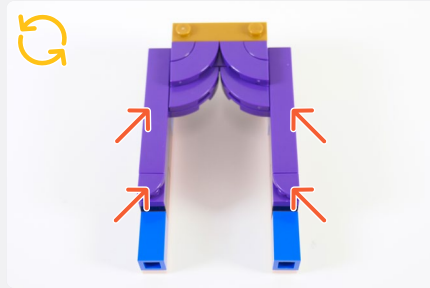
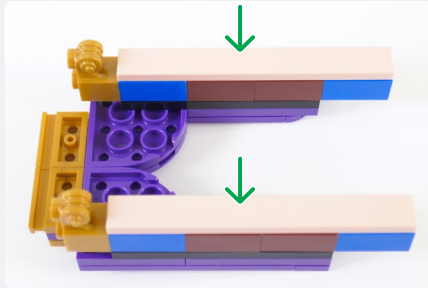
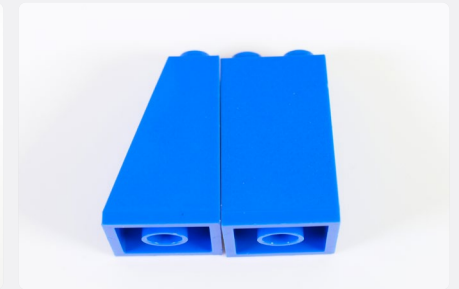

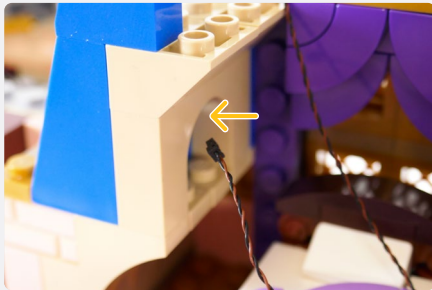
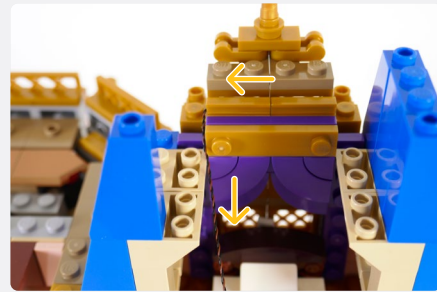
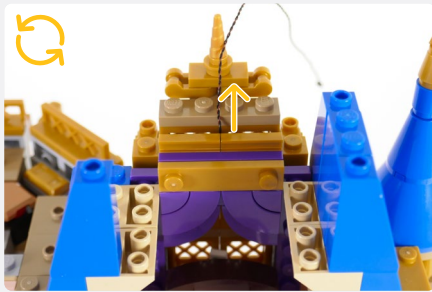

 **NOTE**

Connect the Bit Light to the 12-Port Expansion Board.

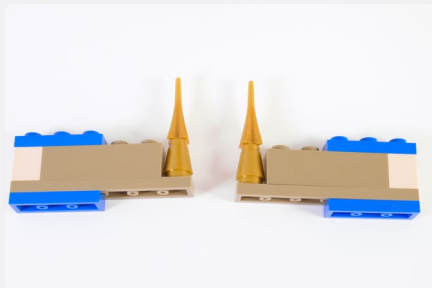
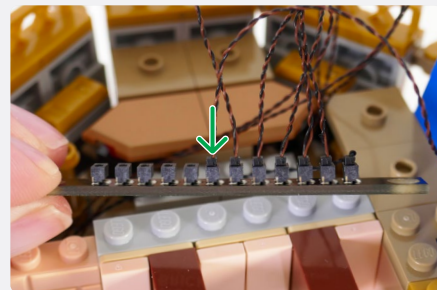

80

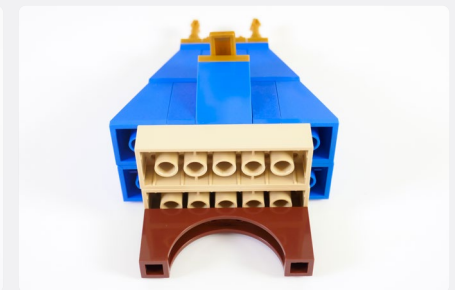
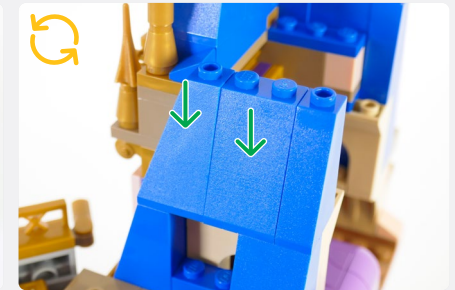
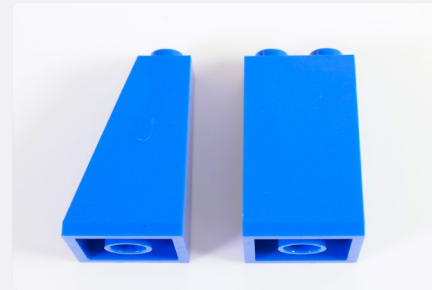
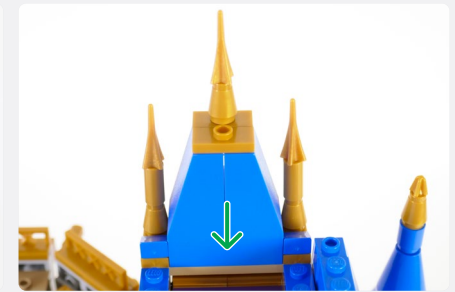
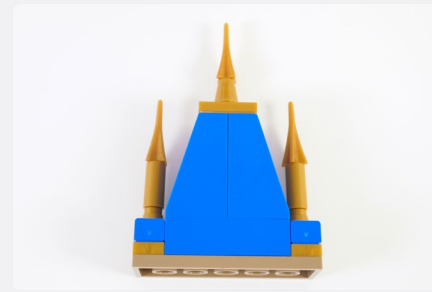

White 15cm Bit Light

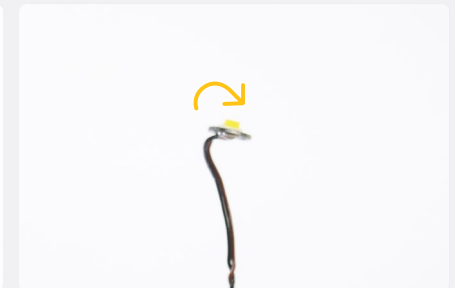

Plate, Round 1x1 with Open Stud
- Black

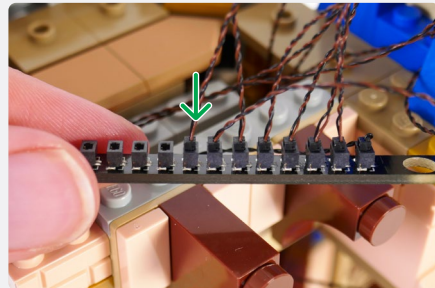
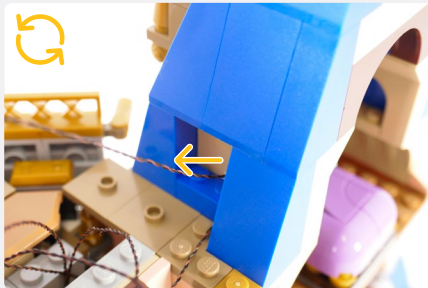
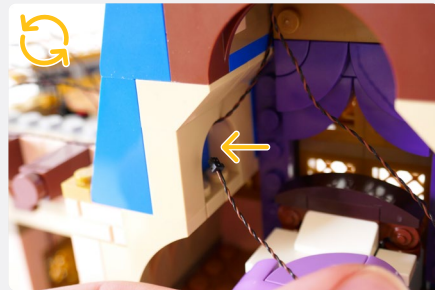
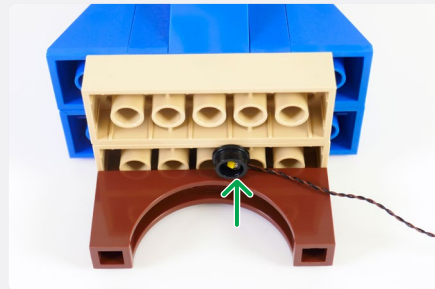

81



NOTE
When reconnecting the sections, ensure the Wireless Power Connectors are aligned, touching and orientated in the same direction.

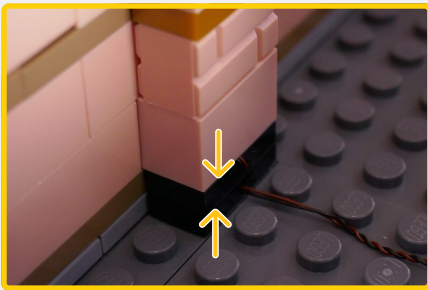
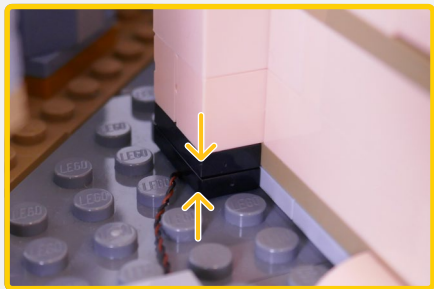

NOTE
Connect to a 5V USB Power Bank, 5V USB Wall Adaptor, or USB to AA Battery Pack (sold separately)





! If you experience any issues with the lights not working and suspect an issue with a component, please try a different port on the expansion board to verify where the fault lies (with the light or expansion board). To correct any issues with expansion board ports, please view the section addressing expansion board issues in our troubleshooting section. i

82

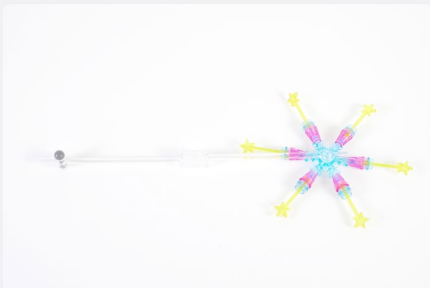

83

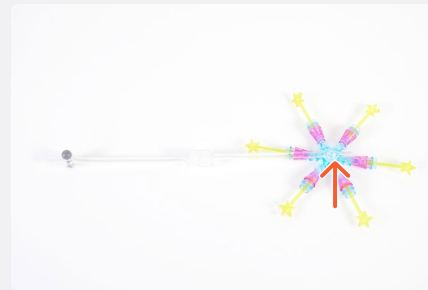

Plate, Round 1x1 - Trans-Light Blue



NOTE

Insert the next LED along the RGB String Light into the 1x1 Cone piece as shown.

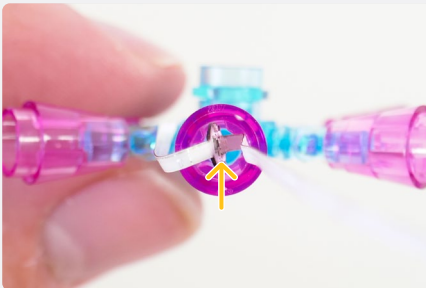

NOTE

Repeat this step for the remaining points and LEDs on the RGB String Light.

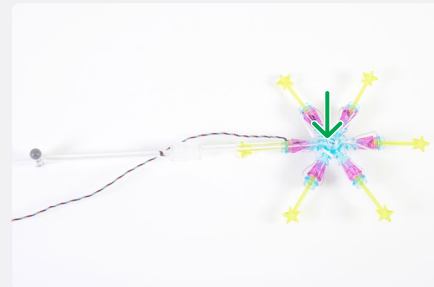

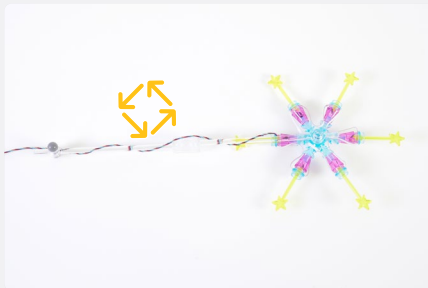

NOTE

Repeat the process for the other firework.

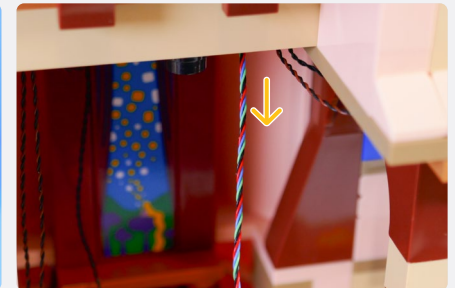
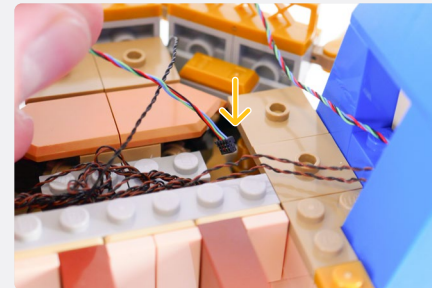
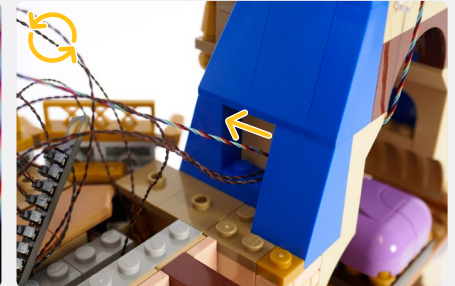
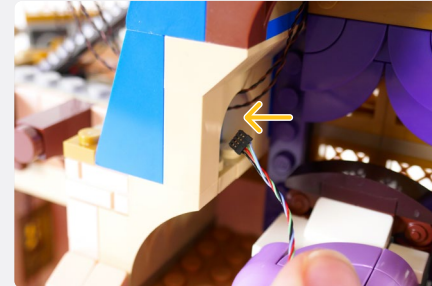
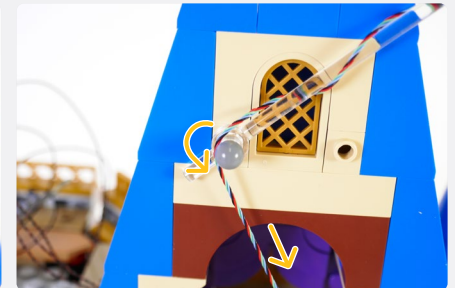
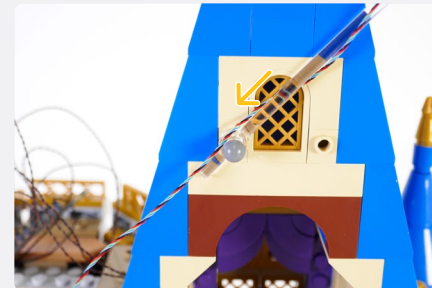
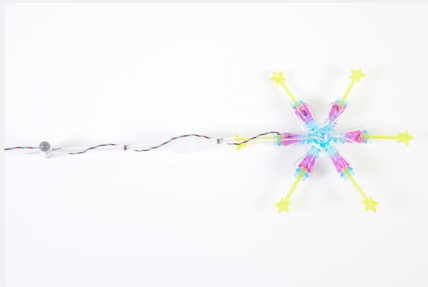
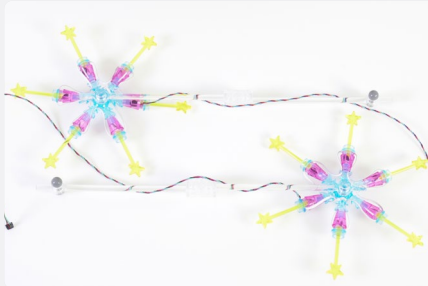

NOTE

Connect the RGB String Light to an "OUT" port on the RGB IR Control Board from Step 52.

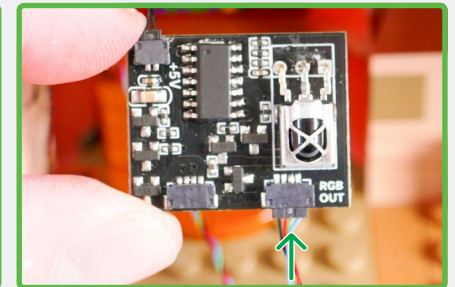

85



White 30cm Bit Light

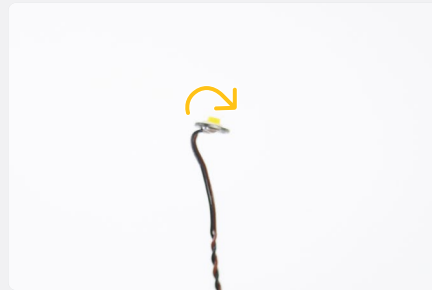

Plate, Round 1x1 with Open Stud - Black

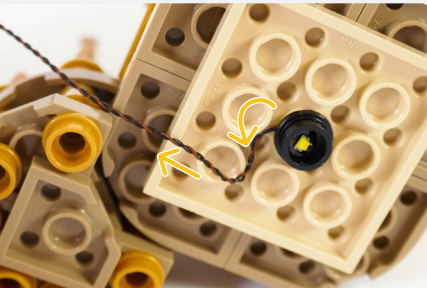
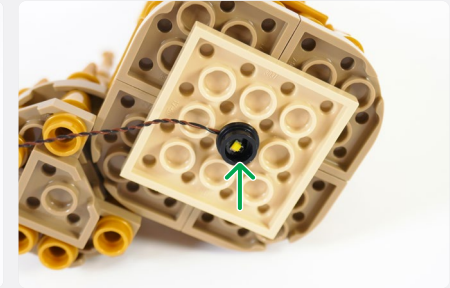
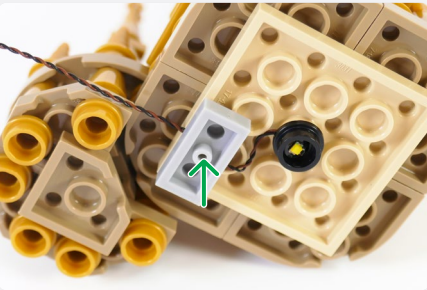
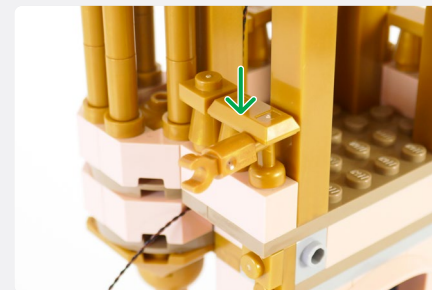
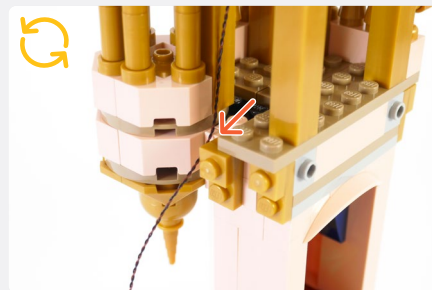
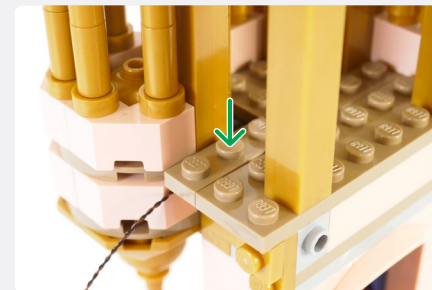
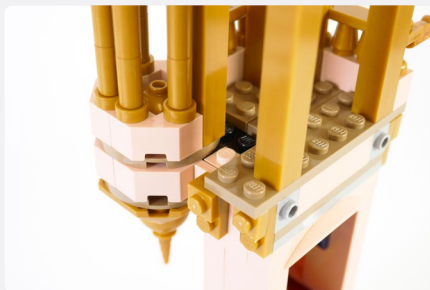
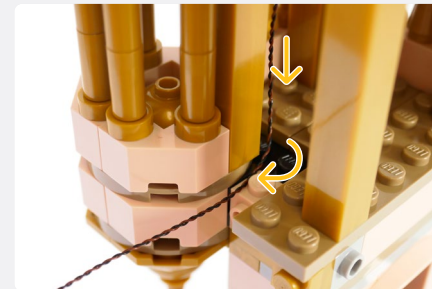
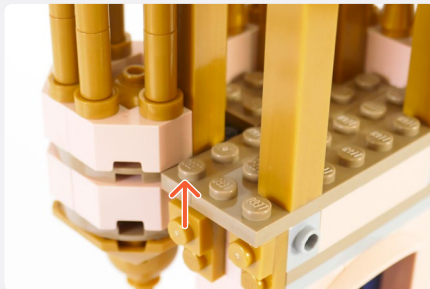
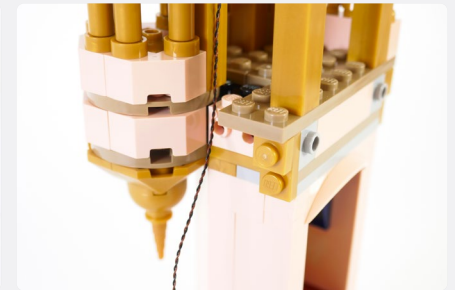
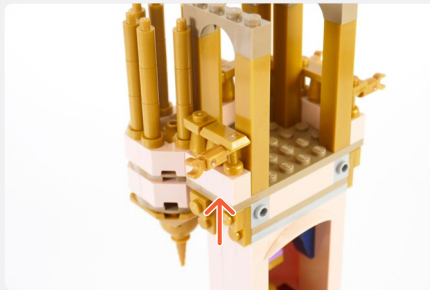

Plate 1x2 - Light Bluish Gray



86



87

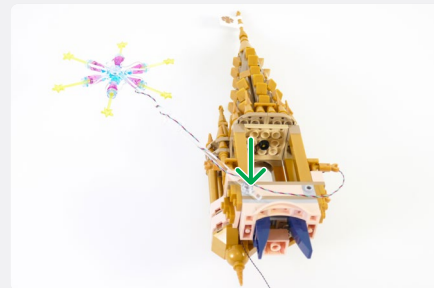
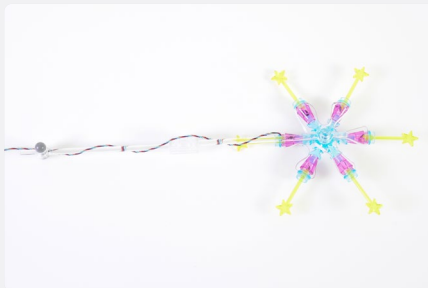
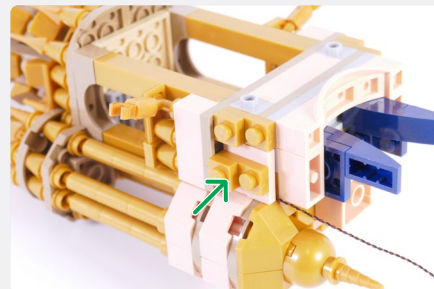
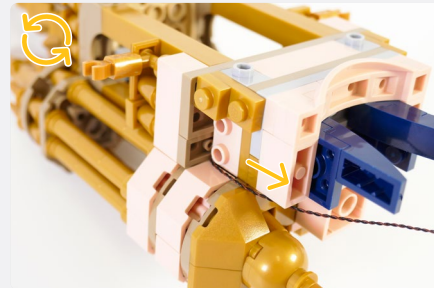
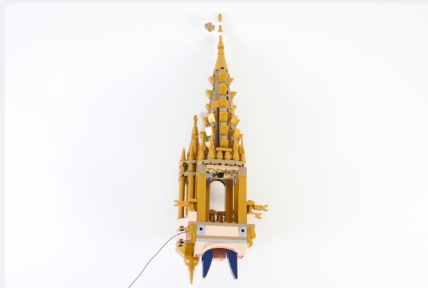
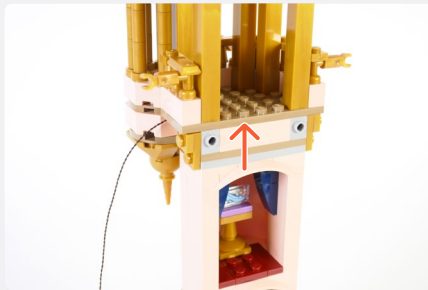

88

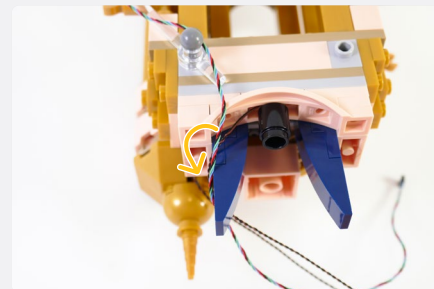
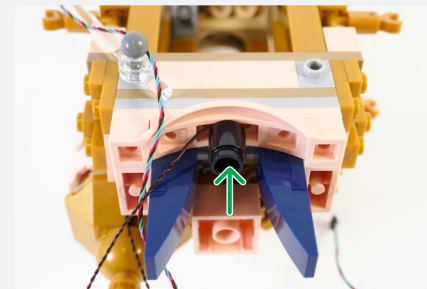
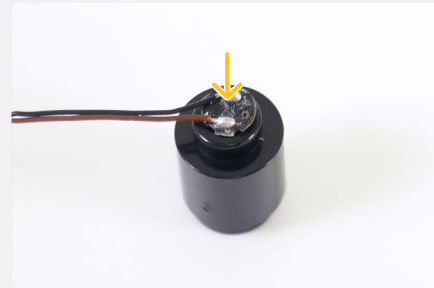
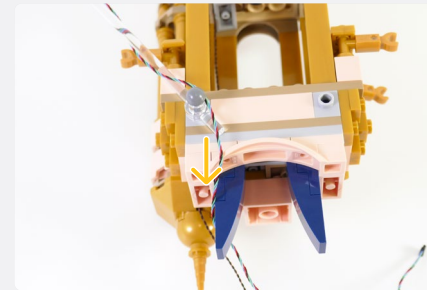

89

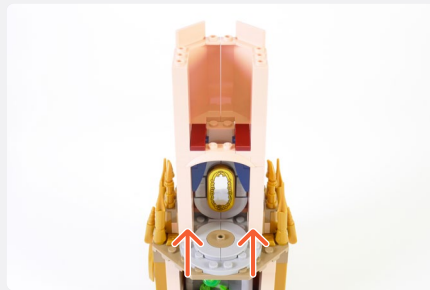
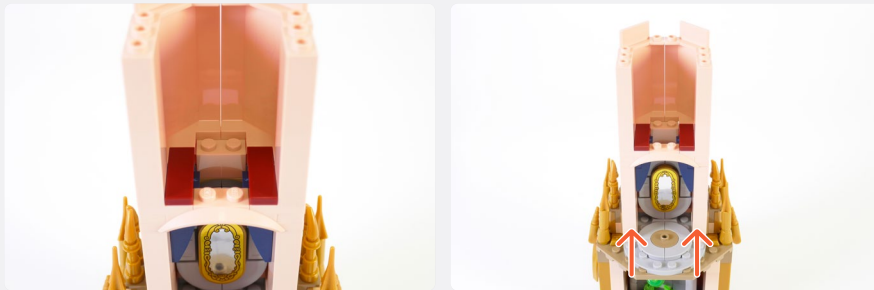

NOTE

Thread the cables from the top level through the hole in the floor.

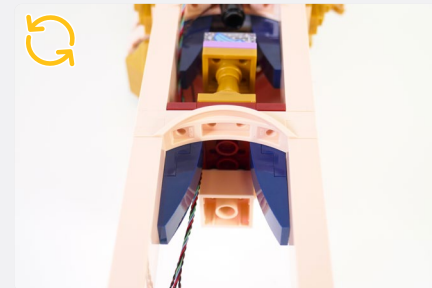
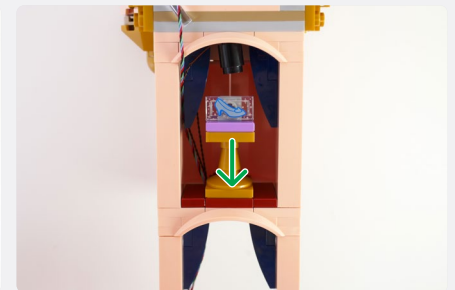
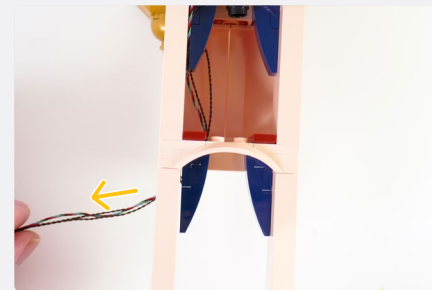
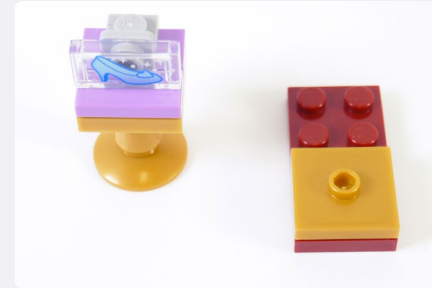
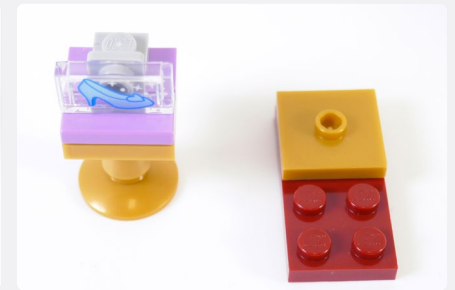
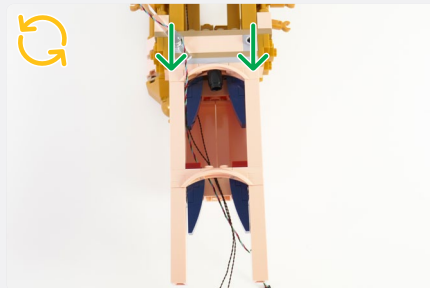
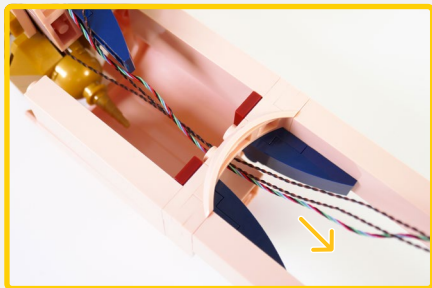
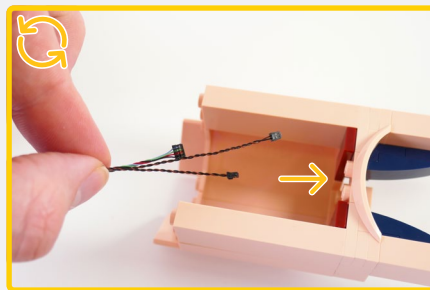

White 15cm Bit Light

Plate, Round 1x1 with Open Stud
- Black

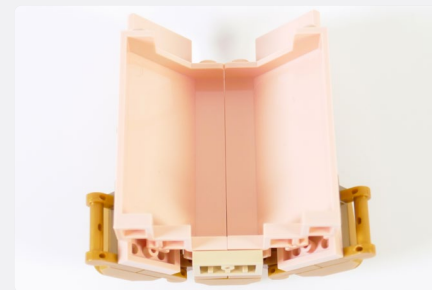
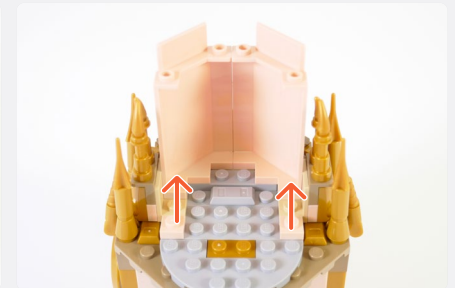
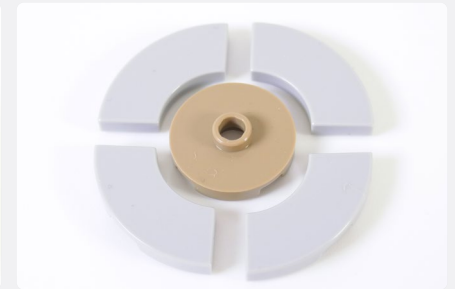
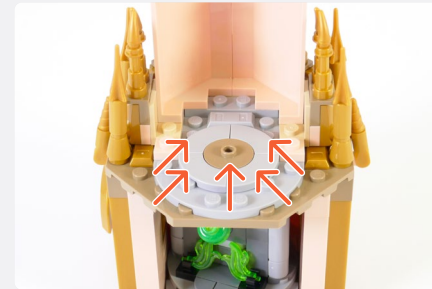
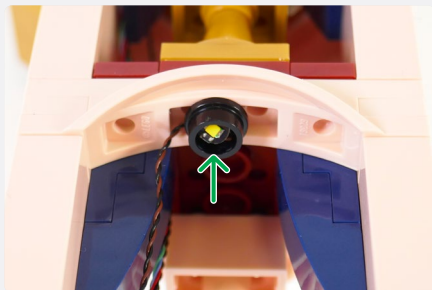
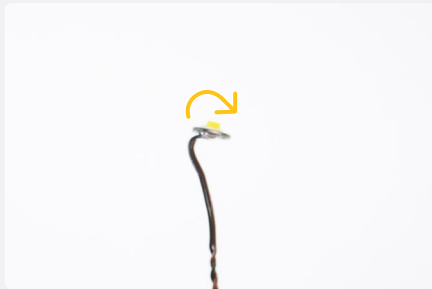

90

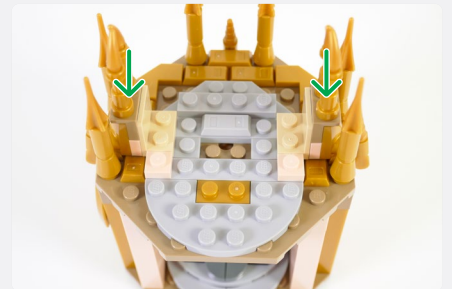
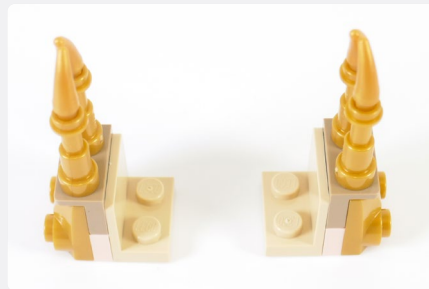
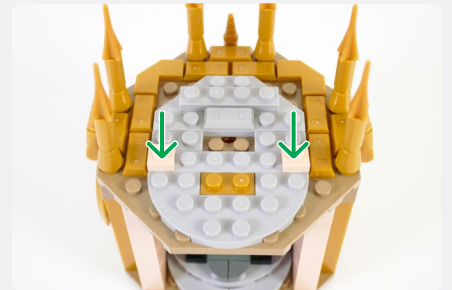
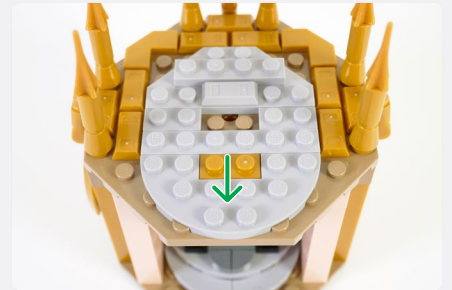
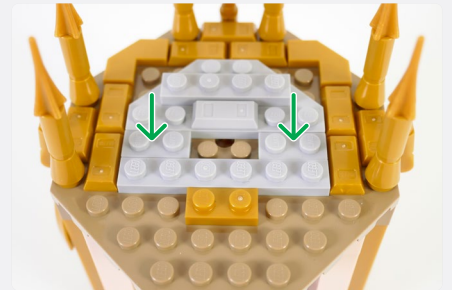
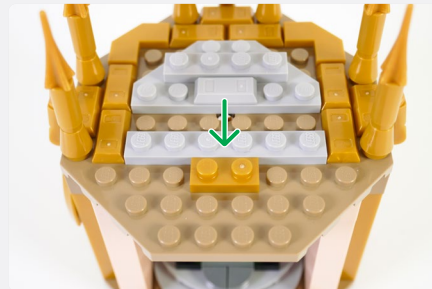
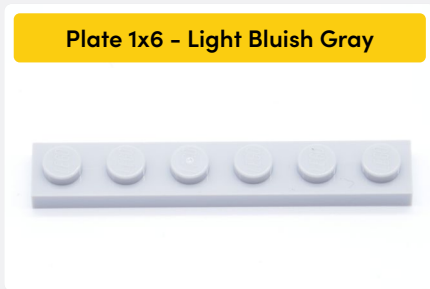

91

Plate 1x6 - Light Bluish Gray

2 x Plate 1x2 - Light Bluish Gray

92

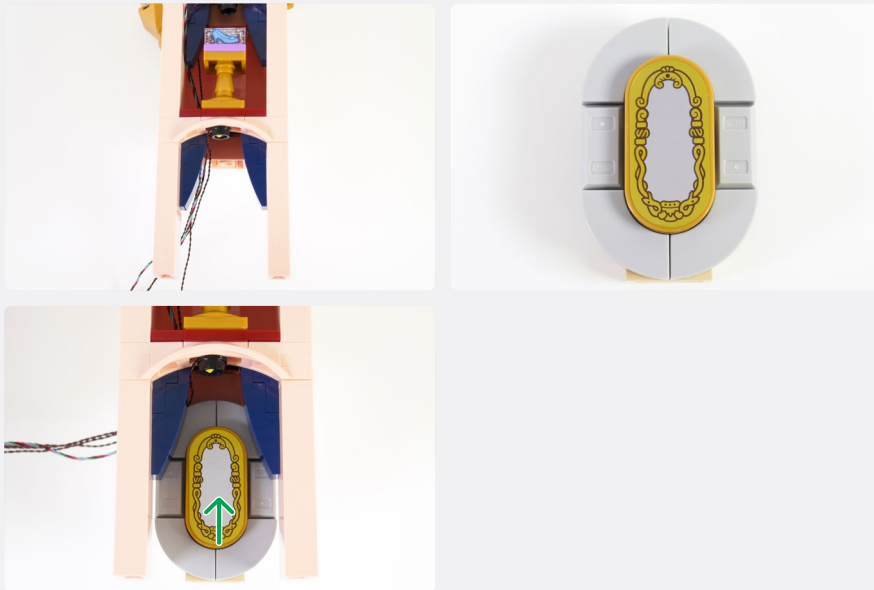

93

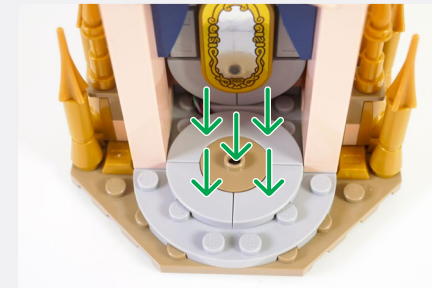
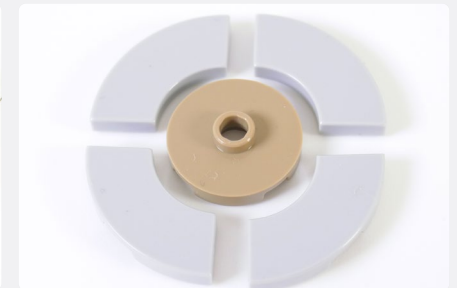
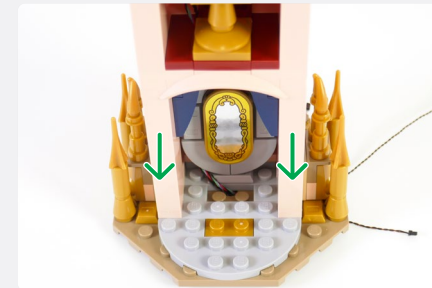
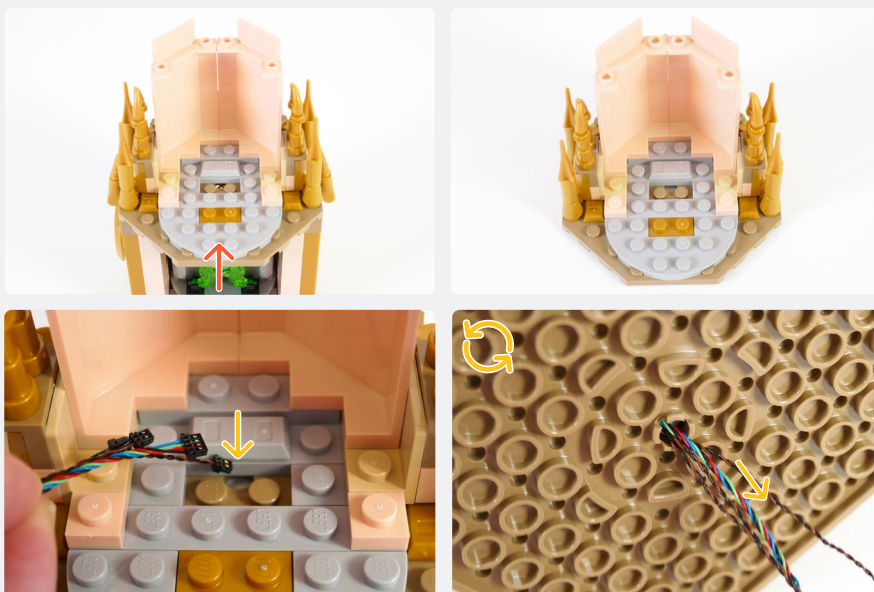

NOTE

Connect the three cables to the 8-Port Expansion Board (excluding the RGB String Light).

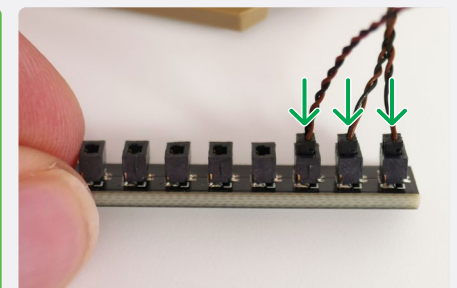

94

Green 30cm Bit Light



Plate, Round 1x1 with Open Stud - Black

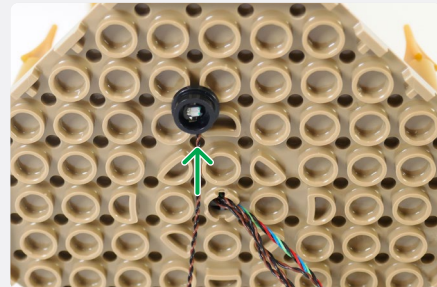
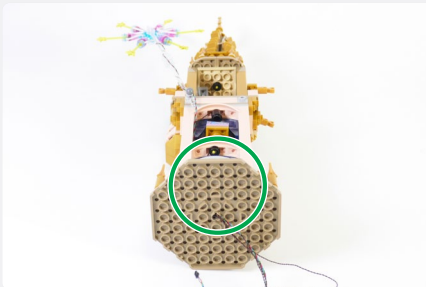
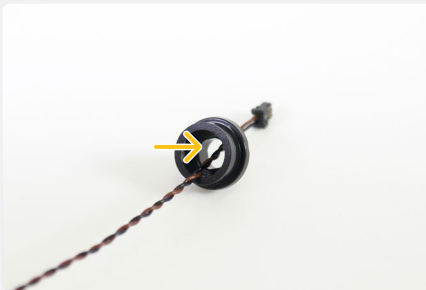

95

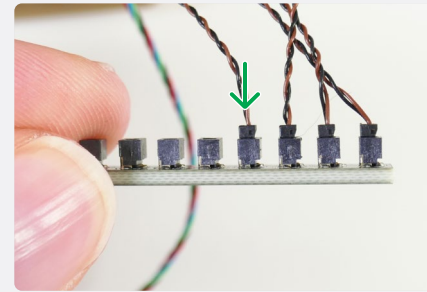

96

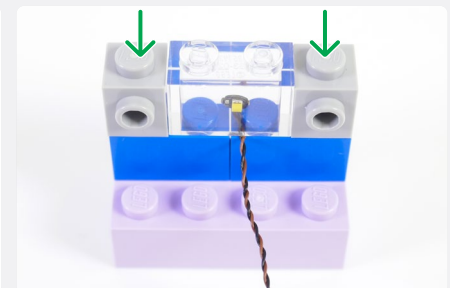
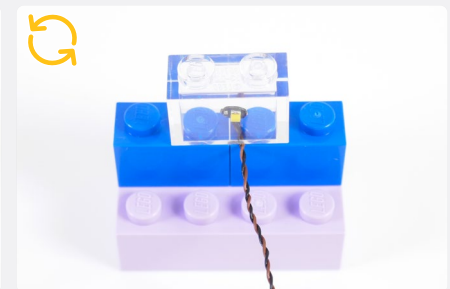
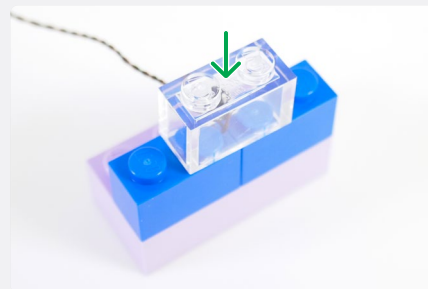
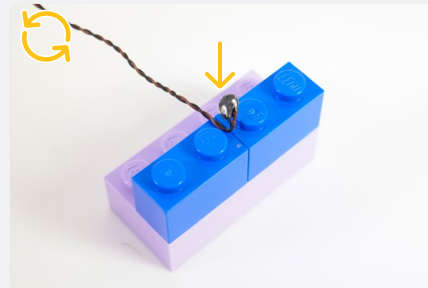
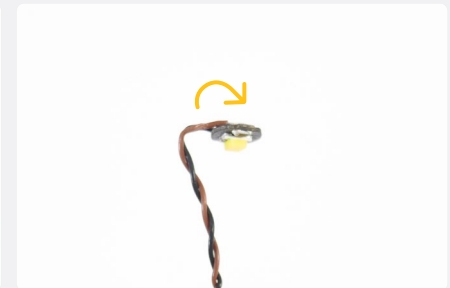
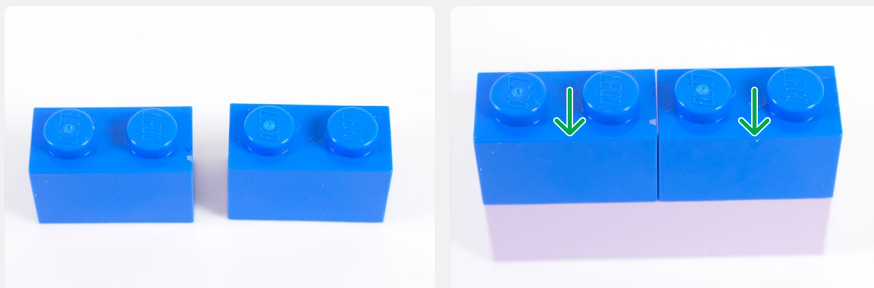

Brick 1x4 - Light Bluish Gray

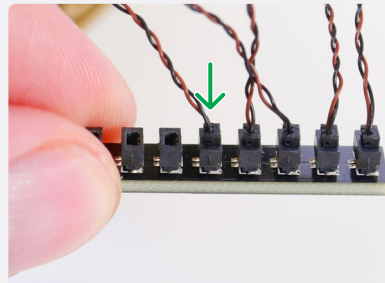
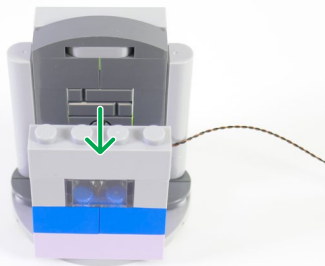
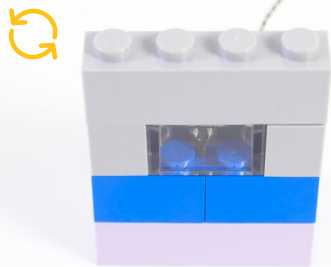
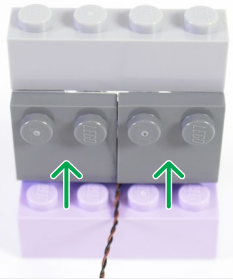
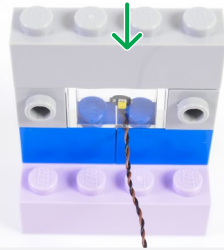

97

30cm Connecting Cable

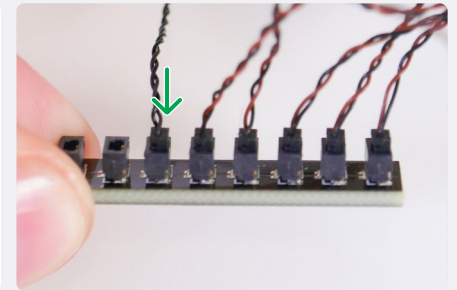

NOTE

Thread the 30cm Connecting Cable and RGB String Light Cable through the hole in the floor.

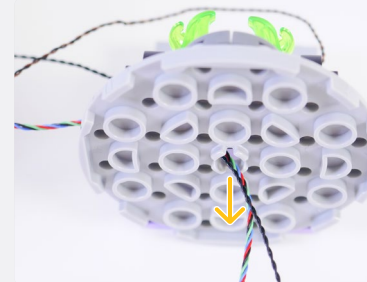
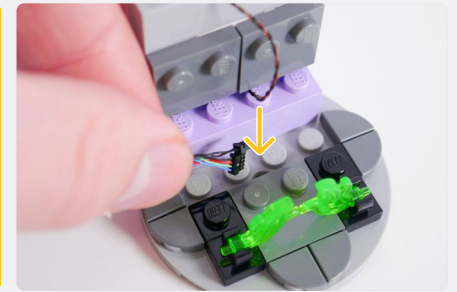

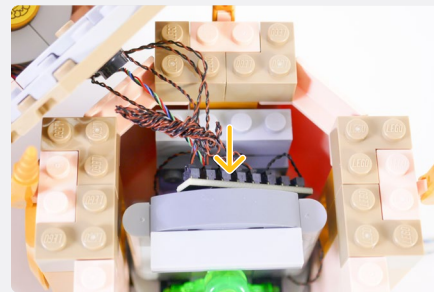
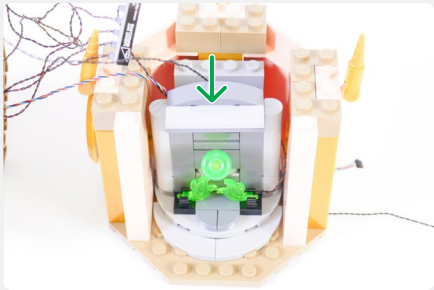
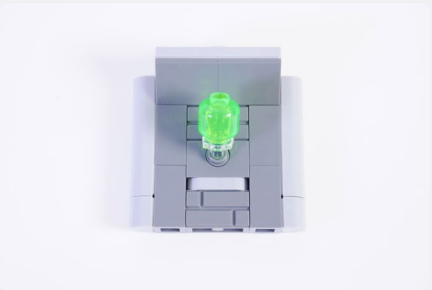
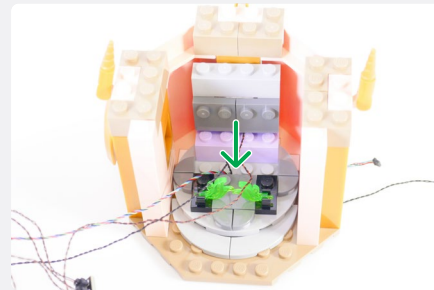
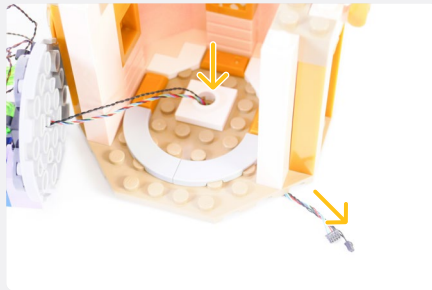

98

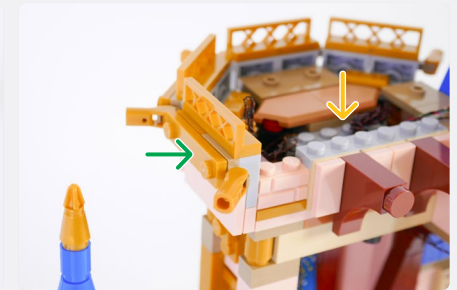
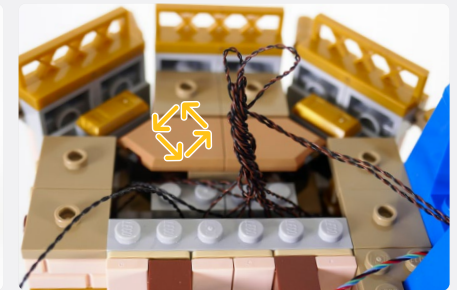

NOTE

Use the box the kit came in to prop up the tower when connecting the cables.

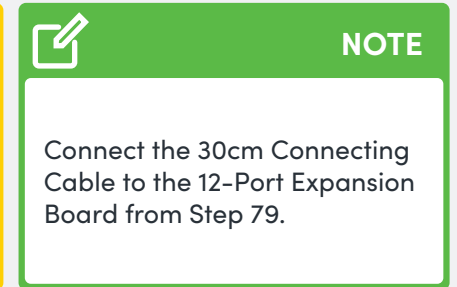

NOTE

Connect the 30cm Connecting Cable to the 12-Port Expansion Board from Step 79.

99

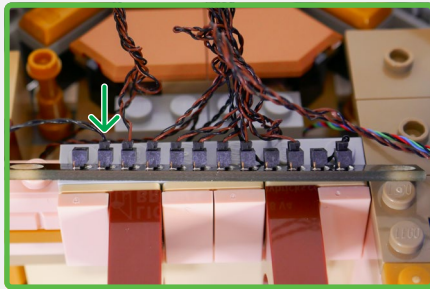

NOTE

Thread the RGB String Light Cable through the hole in the roof as shown.

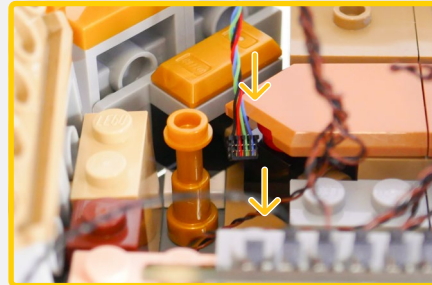

NOTE

Connect the RGB String Light to the second "OUT" port on the RGB IR Control Board.

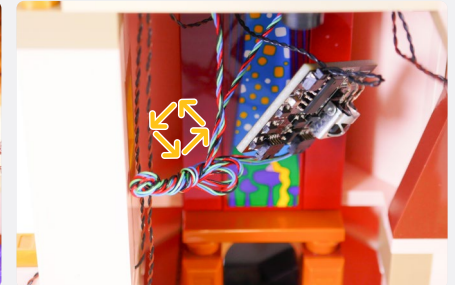
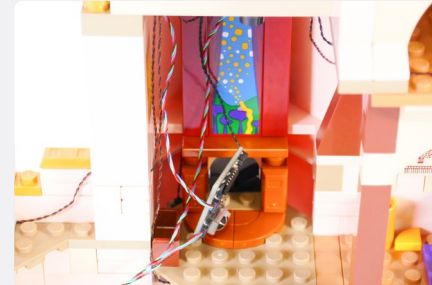
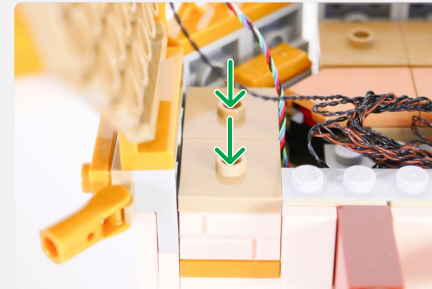
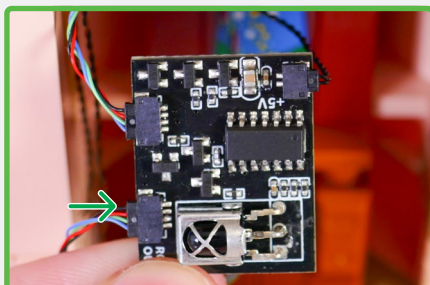
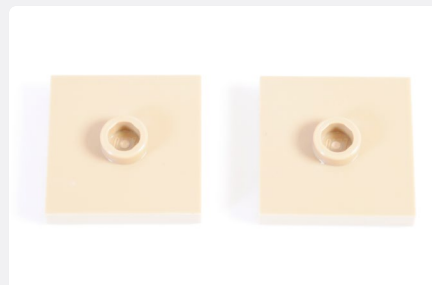
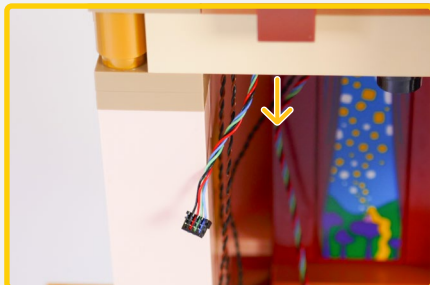

NOTE

Insert the RGB IR Control Board into the roof as shown, ensuring the IR receiver is in sight.

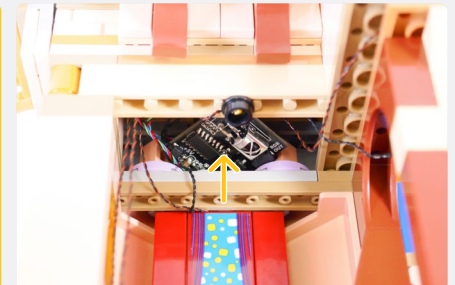

100



NOTE

Connect to a 5V USB Power Bank, 5V USB Wall Adaptor, or USB to AA Battery Pack (sold separately)

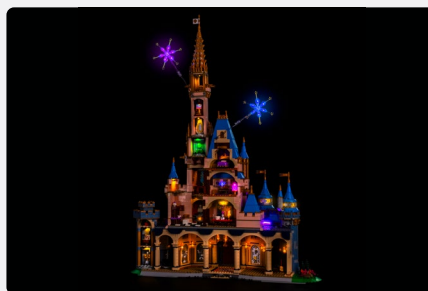
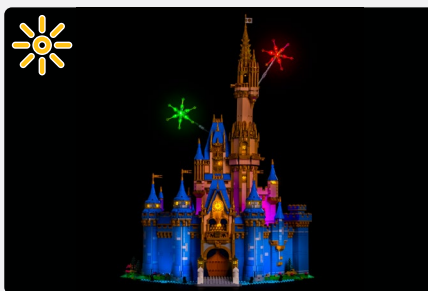

NOTE

You should have these parts left over that were removed from the LEGO set



! If you experience any issues with the lights not working and suspect an issue with a component, please try a different port on the expansion board to verify where the fault lies (with the light or expansion board). To correct any issues with expansion board ports, please view the section addressing expansion board issues in our troubleshooting section. i

FINAL PRODUCT

This finally completes installation of the Light My Bricks

LEGO® Disney Castle 43222 Light Kit.





TROUBLESHOOTING

Light My Bricks lighting kits contain individual components that are very small and can be easily damaged if not handled correctly.

To prevent unnecessary damage to components, we highly recommend that the User Guide section, **“Important things to note”** is read carefully. Follow the handling procedures in the User Guide to help prevent faults and damages to your Light My Bricks components.

If you are experiencing issues with your Light My Bricks set, watch our troubleshooting video or read on for a list of common causes to help you troubleshoot.



Wenn Sie Probleme mit Ihrem Light My Bricks-Set haben, sehen Sie sich unser Video zur Fehlerbehebung an oder lesen Sie die Auflistung der häufigsten Ursachen, die Ihnen bei der Fehlersuche helfen hier.



Si vous rencontrez des problèmes avec votre kit Light My Bricks, regardez notre vidéo de dépannage ou consultez la liste des causes les plus fréquentes pour vous aider à les résoudre ici.



Se si verificano problemi con il set Light My Bricks, guardare il nostro video per la risoluzione dei problemi o leggere l'elenco delle cause più comuni per la risoluzione dei problemi qui.

Troubleshooting

Firstly, ensure that the batteries have power using a battery charge gauge.

If the batteries have no power, replace the batteries.

If the batteries still have power, check to see if the batteries have been inserted correctly into the battery pack.

Check for AA batteries using the AA battery pack

Inside the battery pack are symbols indicating which direction the AA battery should be inserted. The flat side of the battery should be paired with the spring side of the battery pack.

If the batteries have been installed correctly and your kit still isn't operating correctly, the next step is to check the wiring.

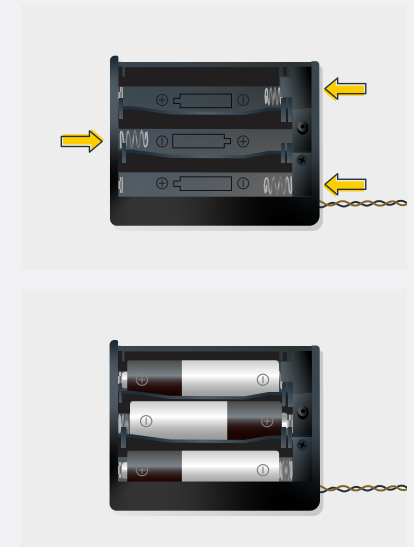

Troubleshooting

Check Your Wires

In order for Light My Bricks components to fit in between and underneath LEGO® bricks, the components need to be very small. Due to this nature, Light My Bricks components can be easily damaged when not handled correctly.

Be careful when removing unpacked components out of the packaging and ensure not to forcibly pull at the wires as this can damage the soldering that attach the wires to the LEDs.

If the wiring is detached from the LED itself, the light will not operate.

When connecting lights to your LEGO® set, check that there are no pinched wires underneath or in between bricks and plates.

When the wires are pinched and the exposed wires are touching each other, this can cause a crosswire and the lights to not function correctly.

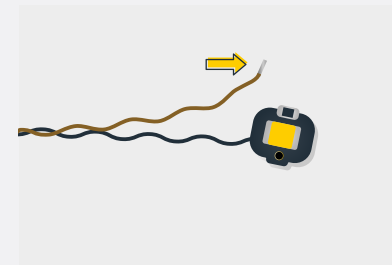
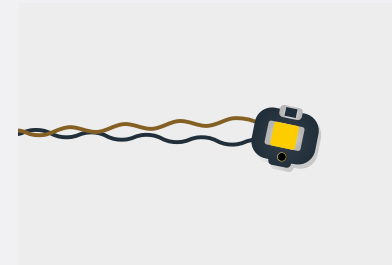

Troubleshooting

Check Your Expansion Board Ports/ Strip Light Ports / Effects Board Ports

It is important to note that connectors can only be inserted to the expansion board, strip light, or effects board ports in one direction.

Forcibly inserting connectors in the incorrect direction will result in damaging the pins inside each of the ports on your component board.

Not only will a light connected to the damaged port not work, but if the pins inside the port are bent to a point they are touching each other, this can result in all other lights in the system to stop working. This is a short circuit.

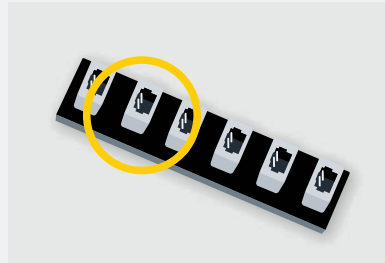

A short circuit can also result in overheating of the board, cable or batteries. If you suspect a short circuit, **DISCONNECT POWER IMMEDIATELY**. Batteries can fail, catch fire, or even explode if left connected to a short circuit for too long.

If you suspect you have a faulty component due to a bent pin, try the following steps:

If you look carefully inside each of the ports, each port contains 2 small pins that should be straight. You will be able to identify a faulty port if it has any bent pins.

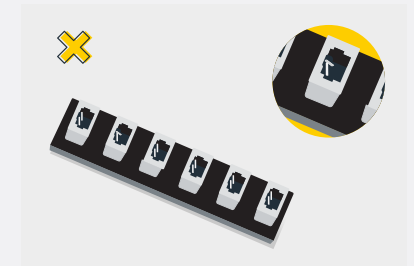
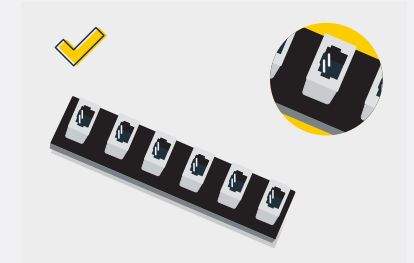
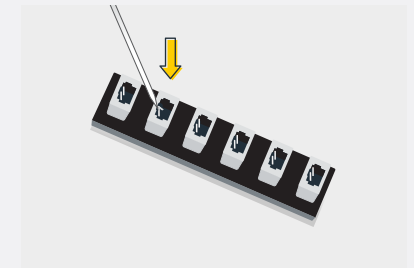



CONTACT US

If you have an enquiry regarding the online shop, our products or a general enquiry please refer to our Frequently Asked Questions webpage.

Alternatively, you can contact our Customer Services team by visiting our online support portal.

support.lightmybrick.com

We thank you for purchasing this product and hope you enjoy!



lightmybricks.com