

WOODEN CITY

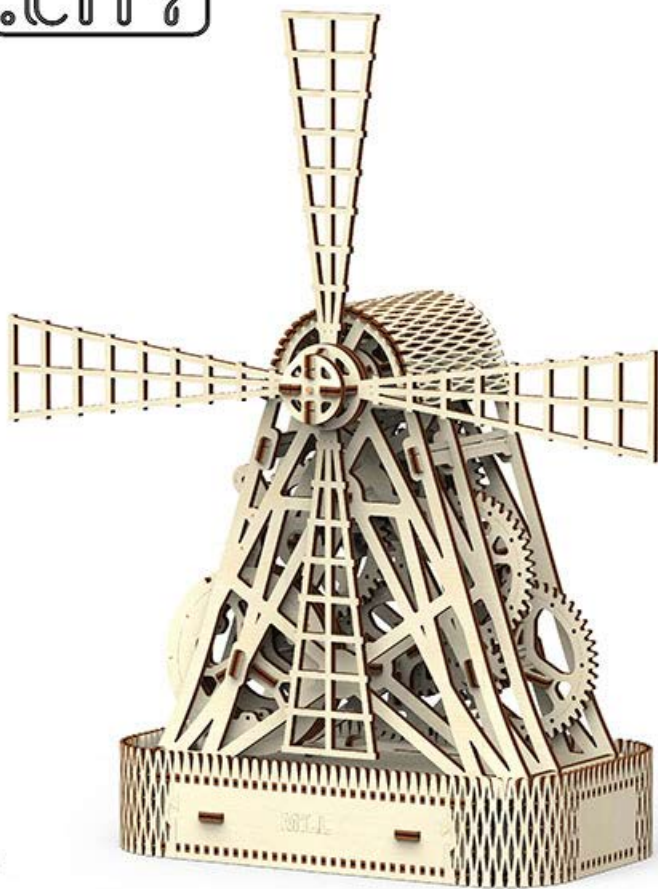

MILL
Assembly instruction

**EN**

Assembly instruction.
Pack contains:

1. 222 parts on 7 ply sheets
2. 29 spare parts
3. Rubbers (for motor)
4. Axles (large and small)
5. Ruler to assist checking of the dimensions

You will need: stationery knife, scissors, emery paper and wax candle. Very carefully squeeze out the details from the obverse side of the board, trying not to break them. If, the detail does not come out, gently cut the jumpers with the stationary knife. This model is assembled without using of glue and does not require the painting. To prevent seizure and to reduce friction the gear face and the axle rotation areas should be waxed. It is recommended to assemble the model with good lighting and to strictly follow the instructions. You can also disassemble this model in a reverse order.

**ES**

Instrucciones de montaje.
El paquete contiene:

1. 222 partes fijadas en las 11 hojas de la madera contrachapada
2. 29 piezas de repuesto
3. Cauchos (para el motor)
4. Ejes (grandes y pequeños)
5. Regla para comprobar las dimensiones

Para el montaje necesitará: cuchillo de papelería, tijeras, papel de lija y una vela. Con mucho cuidado exprimirá los detalles desde el anverso de la tabla, tratando de no romperlos. Si, el detalle no sale, corte suavemente los puentes con el cuchillo estacionario. Este modelo se monta sin pegamento y no requiere la pintura. Para evitar el agarrotamiento y para reducir la fricción, la cara del engranaje y las áreas de rotación del eje deben encerarse. Es recomendable montar el modelo con buena iluminación y seguir estrictamente las instrucciones. También puede desmontar este modelo en orden inverso.

**FR**

Instructions de montage.
Composant modèle:

1. 222 pièces sur quatre panneaux
2. 29 pièces de rechange
3. Gomme
4. Axe épais et mince
5. Il possède une règle pour vérifier les dimensions

Pour l'assemblage, vous auriez besoin : du couteau de papeterie, des ciseaux, du papier de verre et d'une bougie de cire. Il faut enlever les détails tout doucement du côté avant de la feuille, de soi, de façon qu'ils ne soient pas endommagés. Si l'article ne peut pas être retiré, coupez-le avec le couteau de papeterie. Les bavures après les coupures doivent être poncées légèrement avec du papier de verre fin ou coupées soigneusement avec un couteau de papeterie. Le montage du modèle se fait sans colle et ne nécessite pas de peinture. Pour éviter les blocages et pour une meilleur glissement du mécanisme, il faut graisser les extrémités des engrenages et l'axe dans les zones de rotation avec la bougie de cire.

**PL**

Instrukcja składania.
Zestaw zawiera:

1. 222 detali umieszczonych na 7 arkuszach sklejek
2. 29 części zapasowych
3. Gumki
4. Osie grube i cienkie
5. Linijka do sprawdzania wymiarów

Do złożenia modelu niezbędne będą: nóż techniczny, nożyczki, papier ścierny oraz świeca woskowa. Detale wypycha się delikatnie od prawej strony arkusza uważając, aby ich nie uszkodzić. Jeżeli wystąpi trudności z wyciśnięciem pożądanego elementu, wówczas należy go delikatnie naciąć nożykiem z lewej strony arkusza. Powinno się wypychać z arkusza tylko te elementy nad którymi aktualnie się pracuje, w przeciwnym razie mogą się pogubić. Model należy składać przy dobrze doświetlonym stanowisku zgodnie z instrukcją. Model można rozłożyć w odwrotnej kolejności. Model składa się bez użycia kleju. W celu prawidłowego funkcjonowania mechanizmu, należy osie i koła zębate natrzeć świecą woskową. Uwaga: pozostałości po zaczepach technicznych na detalach można usunąć drobnziarnistym papierem ściernym lub nożem technicznym.

**DE**

Aufbauanleitung.
Im Set enthalten:

1. 222 Teile in 7 Platten
2. 29 Ersatzteile
3. Gummi
4. Achsen in 2 Ausführungen
5. Lineal zur Kontrolle

Fürs Zusammenbauen benötigen Sie: Messer, Schere, Schleifpapier und eine Kerze. Die Einzelteile werden von der Oberseite nach unten ausgedrückt. Wenn sich ein Teil nicht herausnehmen lässt, schneiden Sie die Haltestege mit dem Messer leicht ein Um ein Steckenbleiben vorzubeugen, schmieren Sie die Achsen und Zahnräder etwas mit dem Kerzenwachs ein. Sie beim Zusammenbau für eine gute Beleuchtung und setzen die Einzelteile strickt nach der Anleitung zusammen. Modell kann auch wieder auseinandergebaut werden.

**CN**

裝配說明。

每盒模型包括：

- 1、7片樺木板，合共222件零件
- 2、29件備用零件
- 3、橡筋圈(作馬達之用)
- 4、粗幼輪軸兩款
- 5、輔助測量尺

建議工具：界紙刀、剪刀、木砂紙和小蠟燭。請在光線充足下按照說明書上指示小心取出所需之零件，或可用界紙刀協助切斷接連位。組合輕鬆無需膠水接合或塗上色彩。請在指定位置塗上蠟燭幫助輪軸、齒輪等部件運行暢順。可按照組合之相反順序修正或重新組合模型。

**RU**

Инструкция по сборке.
Комплектация модели:

1. 222 деталей расположенных на 7 листах
2. 29 запасных деталей
3. Резинки
4. Оси толстые и тонкие
5. Линейка для проверки размеров

Для сборки вам понадобится: канцелярский нож, ножницы, наждачная бумага и восковая свеча. Выдавливать детали нужно аккуратно с лицевой стороны листа от себя, чтобы их не повредить. Если деталь не вынимается, надрежьте перемычки канцелярским ножом. Модель собирается без клея и не требует покраски. Для предотвращения заклинивания и наилучшего скольжения механизма, необходимо торец шестерни и оси в местах вращения смазать восковой свечой. Собрать модель рекомендуется при хорошем освещении и строго по инструкции. Разбирать можно в обратной последовательности.

**IT**

Istruzioni di montaggio.
La scatola contiene:

1. 222 pezzi situati sui 7 fogli
2. 29 pezzi di ricambio
3. Gomme
4. Asse sottile e spessa
5. La linea per controllare le dimension

Informazioni utili : Premere delicatamente sui pezzi pretagliati, dalla parte anteriore del foglio, per non rovinarli. Se il singolo pezzo non può essere rimosso , fate piccoli tagli con un taglierino da cancelleria. Il modello si monta senza colla e non ha bisogno di essere pitturato. Per evitare inceppamenti e migliorare lo scivolamento dei meccanismi, attrezzarsi di un prodotto lubrificante tipo cera di candela. Si consiglia di montare il modello con la luce adeguata e seguendo le istruzioni.Lo smontaggio dello stesso può avvenire con le dovute precauzioni.

EN Notations. FR Désignations symboliques. ES Notas.
 PL Oznaczenia umowne. DE Symbolbezeichnung. RU Условные обозначения.

IT Simboli. CN 注解：



EN Approximate assembly time.
 FR Temps d'assemblage estimé.
 ES Tiempo aproximado del montaje.
 PL Przybliżony czas składania.
 DE Aufbauzeit.
 RU Примерное время сборки.
 IT Tempo di costruzione stimato.
 CN 組合預計時間



EN Check elements position.
 FR Vérifiez l'emplacement des éléments.
 ES Comprobar la posición de los elementos.
 PL Uwaga! sprawdź rozmieszczenie elementów.
 DE Prüfen Sie die Position der Elemente.
 RU Проверьте расположение элементов.
 IT Controllare le posizioni degli elementi.
 CN 檢查零件組合位置



EN Check measurements.
 FR Vérifiez les dimensions.
 ES Comprobar los tamaños.
 PL Sprawdź rozmiar.
 DE Prüfen Sie die Abmessungen.
 RU Проверьте размеры.
 IT Controllare le dimensioni.
 CN 檢查尺寸



EN Press up to the stop.
 FR Appuyez au maximum.
 ES Presione hasta el tope.
 PL Wciśnij do oporu.
 DE Bis zum Anschlag zusammendrücken.
 RU Прижмите до упора.
 IT Premere per interrompere.
 CN 緊接組合

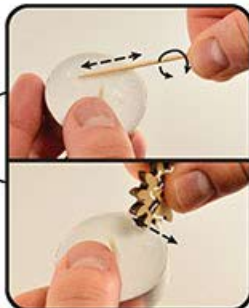

EN Wax the details.
 FR Lubrifiez les pièces avec la bougie.
 ES Cera los detalles.
 PL Natrzyj element świecą woskową.
 DE Mit Kerzenwachs einschmieren.
 RU Смажьте детали свечкой.
 IT Candela per Lubrificare le parti.
 CN 塗上蠟燭



EN Spare details.
 FR Pièces de rechange.
 ES Detalles de repuesto.
 PL Części zamienne.
 DE Ersatzteile.
 RU Запасные детали.
 IT Pezzi di ricambio.
 CN 備用零件



EN Cut off with a knife.
 FR Coupez avec le couteau.
 ES Cortar con el cuchillo.
 PL Odetni nożem.
 DE Abschneiden.
 RU Отрезать ножом.
 IT Tagliarino.
 CN 使用界紙刀切斷



EN Carefully move apart.
 FR Faites séparer délicatement.
 ES Separar cuidadosamente.
 PL Delikatnie rozsunąć detale.
 DE Vorsichtig auseinanderschieben.
 RU Аккуратно раздвинуть.
 IT Far scorrere delicatamente.
 CN 輕力分開



EN Burrs on the jumper should be gently grinded with the emery paper or carefully cut with the stationary knife.
 FR Les bavures après les coupes doivent être poncées légèrement avec du papier de verre fin ou coupées soigneusement avec un couteau de papeterie.
 ES Las rebabas en el puente deben ser amoladas suavemente con el papel esmeril o cortadas cuidadosamente con el cuchillo estacionario.
 PL Uwaga: pozostałości po zczepach technicznych na detalach można usunąć drobnonazistym papierem ściernym lub nożem technicznym.
 DE Eventuell verbleibende Haltereste mit Messer oder Schlepppapier entfernen. Das Modell wird ohne Kleber zusammengesetzt.
 RU Застусцы от перемычек следует отшлифовать легкими движениями мелкой наждачной бумагой или аккуратно срезать канцелярским ножом.
 IT Le barbe (residui di legno) dei pezzettini devono essere levigate leggermente con la sottile carta vetrata o tagliati con cautela con il tagliarino da cancelleria.
 CN 可用水砂紙或界紙刀輕輕磨掉零件上毛刺。



EN The part numbers that are included in this node.
 FR Les références sont incluses dans cette unite.
 ES Números de piezas que forman parte de la junta.
 PL Numery części, które wchodzić do składu danego podzespołu.
 DE Die Nummern der Details, die diesem Teil des Modells gehören.
 RU Номера деталей которые входят в этот узел.
 IT Numero di pezzi per questo nodo.
 CN 此信息已包括所需要組件編號。

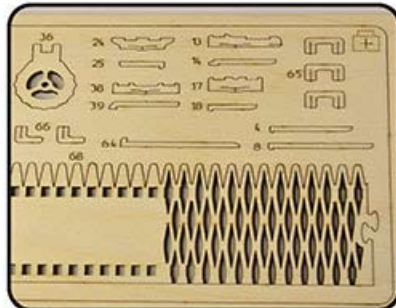
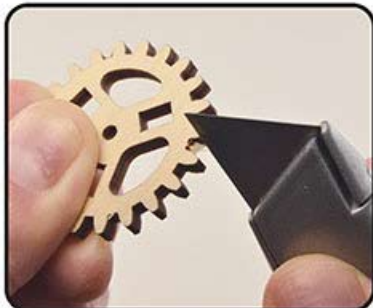

EN The scale for size check. **FR** La règle pour vérifier les dimensions. **ES** La escala para la verificación de tamaño. **PL** Linijka do sprawdzenia wymiarów. **DE** Lineal um diverse Abmessungen zu prüfen. **RU** Линейка для проверки размеров. **IT** La linea per controllare le dimensioni. **CN** 輔助測量尺。

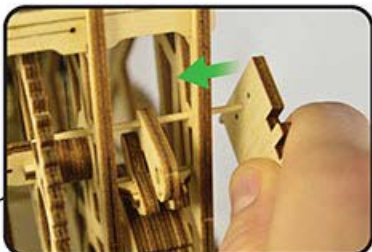

EN These holes help to push thin axle through several details. **FR** Les ouvertures indiquées vous aident à pousser l'axe fin à travers quelques détails. **ES** Estos agujeros ayudan a empujar el eje delgado a través de varios detalles sobre ejes. **PL** Otwory w linijce mogą być pomocne przy przeciskaniu patyczków (osi) przez kilka elementów. **DE** Die angegebenen Öffnungen helfen Ihnen, eine dünne Achse durch mehrere Öffnungen zu schieben. **RU** Указанные отверстия помогут протолкнуть тонкую ось через несколько деталей. **IT** Questi piccoli fori aiuteranno a spingere ed inserire l'asse attraverso le piccole parti. **CN** 輔助測量尺上的小孔可幫助緊接小輪軸。

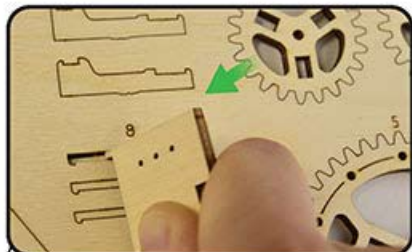

EN The ledge is for squeezing the small details out of the board. You can also push the small details out in the process of disassembly. **FR** La protubérance est conçue pour aider à presser et enlever les petits détails de la feuille. On peut l'utiliser aussi pour pousser les petites pièces lors du démontage du modèle. **ES** La repisa es para apretar los pequeños detalles fuera del tablero. Además, también puede empujar los pequeños detalles en el proceso de desmontaje. **PL** Występ w linijce przeznaczony jest do wyskakiwania małych detali z arkusza sklejki. Można go wykorzystać również przy rozkładaniu modelu. **DE** Der Vorsprung dient dazu, kleine Teile aus den Platten zu drücken. Er kann auch zum Ausdrücken kleiner Teile beim Auseinanderbauen des Modells benutzt werden. **RU** Выступ предназначен для выталкивания из листа мелких деталей. Также им можно выталкивать мелкие детали при разборке модели. **IT** Le proiezioni riportate sui fogli di istruzioni sono utili anche nella fase di smontaggio per estrarre i pezzi. **CN** 輔助測量尺只幫助取出或緊接細小零件時使用。

EN This detail is for easy installation of the rubber. **FR** Cet article permet une installation facile de l'élastique. **ES** Este detalle es para la instalación fácil del caucho. **PL** Służy do łatwiejszego montażu gumki napędowej. **DE** Dieses Teil vereinfacht die Installation des Gummis. **RU** Эта деталь - для удобной установки резинки. **IT** Questo dettaglio serve per il comodo montaggio dell'elastico. **CN** 此小工具輔助安裝橡筋圈。



EN Yellow rubber is for the rotation of the model mechanism. Install it as it is shown on the picture. **FR** L'élastique jaune est conçu pour faire tourner le mécanisme du modèle. Installez-le comme est indiqué sur le dessin. **ES** El caucho amarillo es para la rotación del mecanismo del modelo. Instálalo como se muestra en la imagen. **PL** Żółta gumka przeznaczona jest do napędu mechanizmu modelu. Zamontować ją należy zgodnie z instrukcją. **DE** Gelbes Gummiband dient dazu, den Mechanismus zu drehen. **RU** Желтая резинка предназначена для вращения механизма модели. Установите её как показано на рисунке. **IT** Elastico giallo serve per il movimento del meccanismo del modello. Installare come mostrato nel disegno. **CN** 請按照圖示安裝黃色橡筋圈。

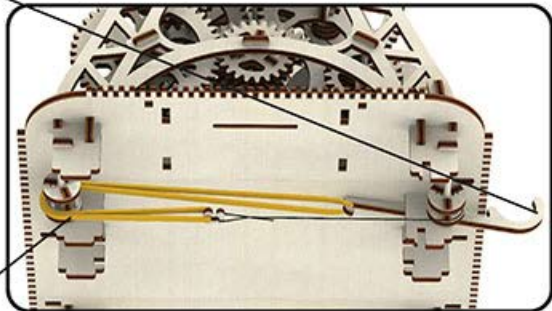

EN Axles large and small. FR Axe épais et mince. ES Ejes grandes y pequeños. PL Osie grube i cienkie.
DE Achsen in dick und dünn. RU Оси толстые и тонкие. IT Asse sottili e spessa. CN 粗幼輪軸兩款

EN Thread. FR Fil. ES Hilo. PL Nitka.
DE Faden. RU Нитка. IT Filo. CN 黑色線

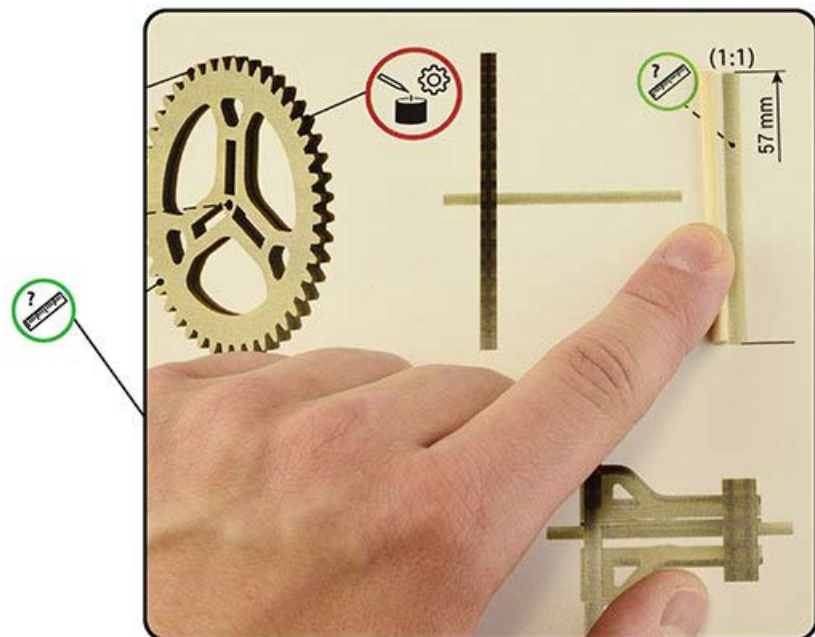
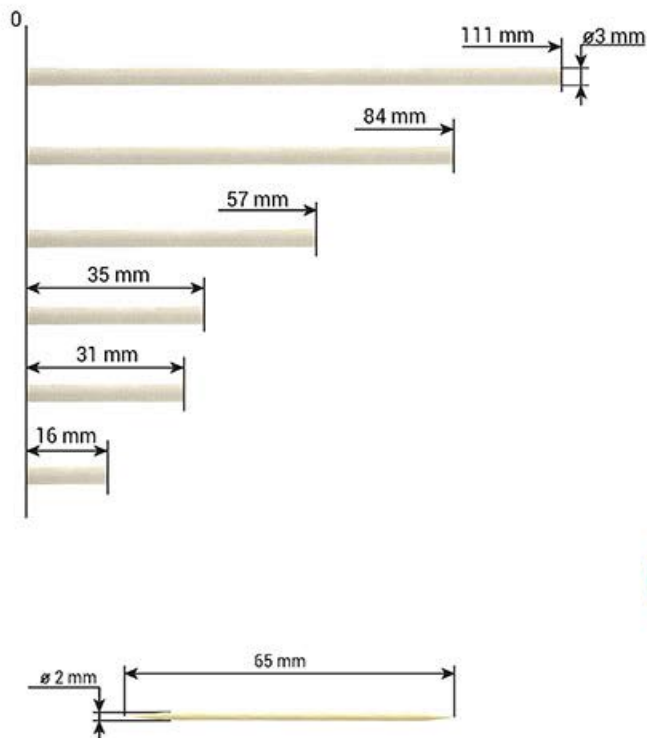

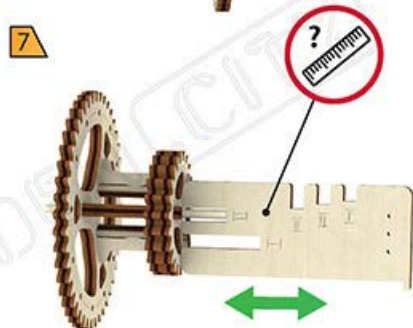
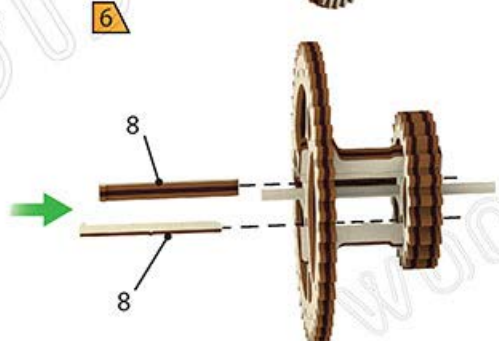
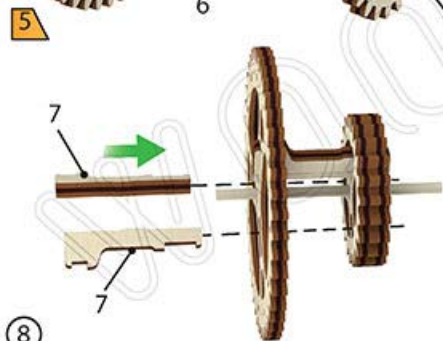
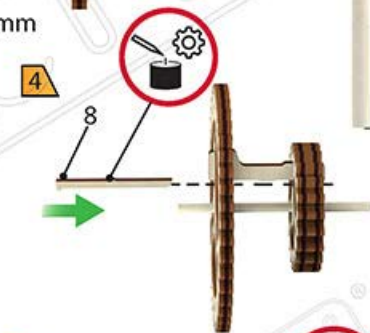
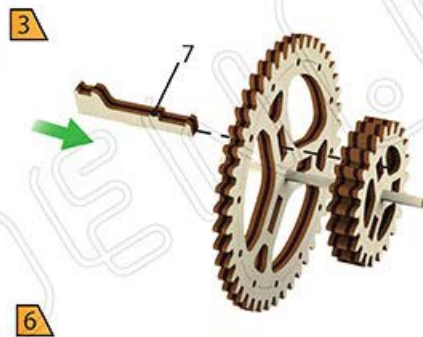
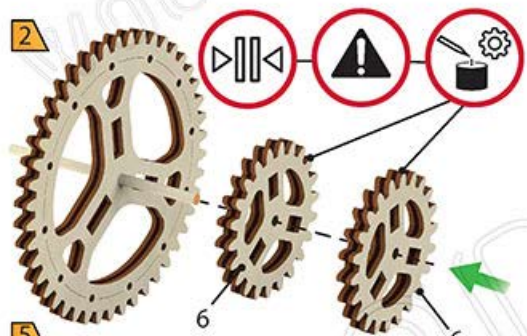
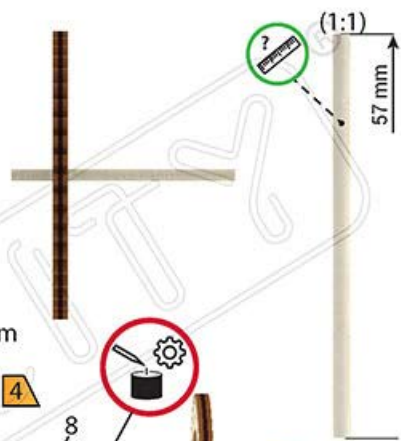
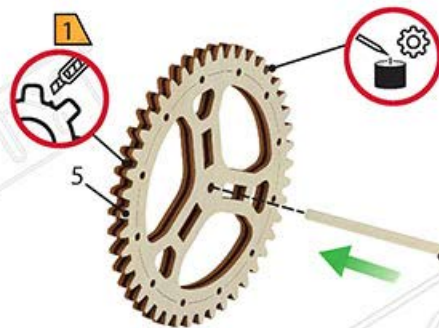
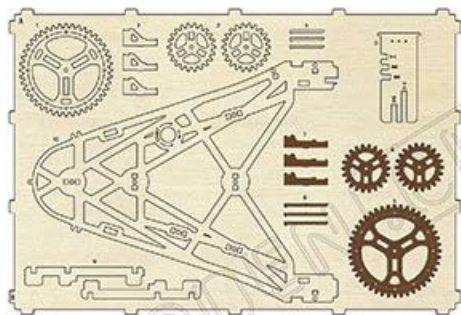

8

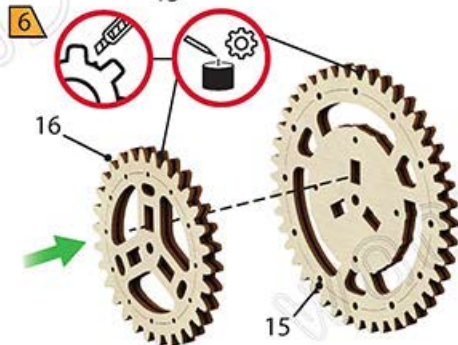
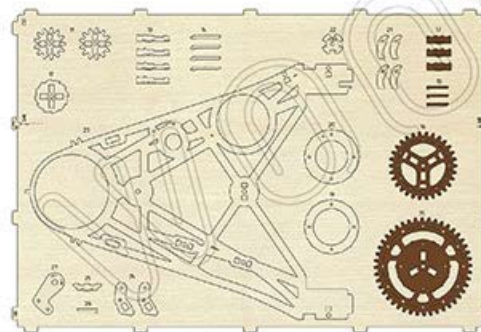
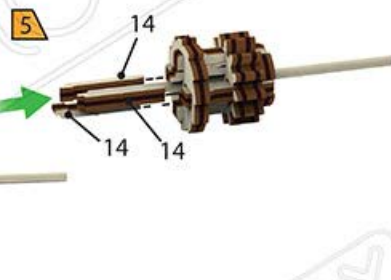
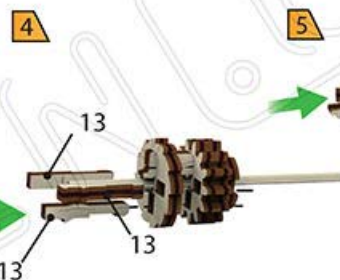
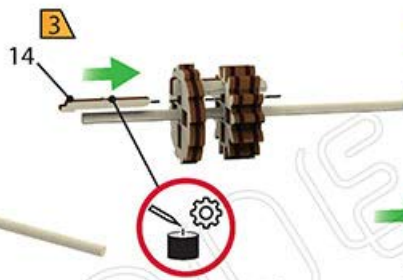
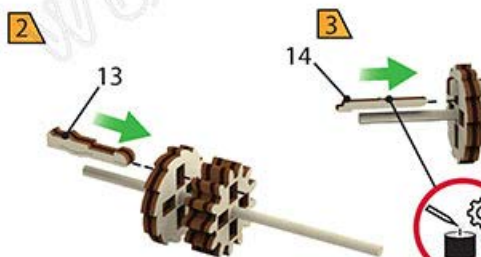
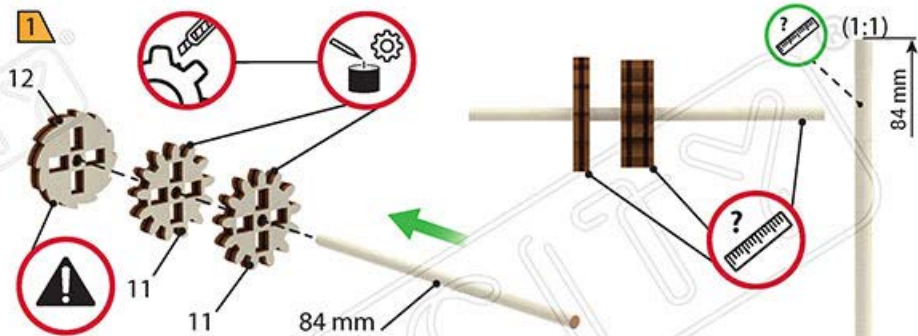
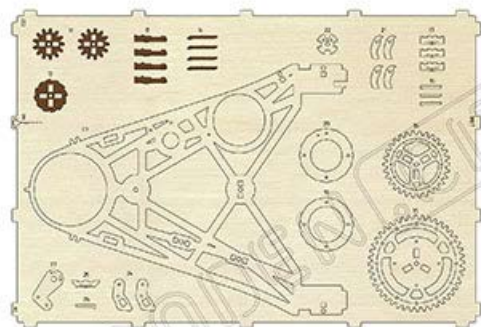

8

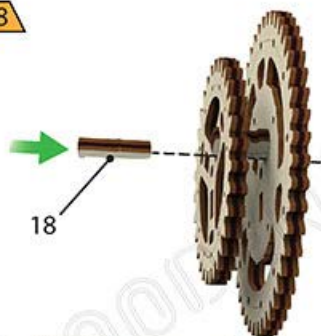

9

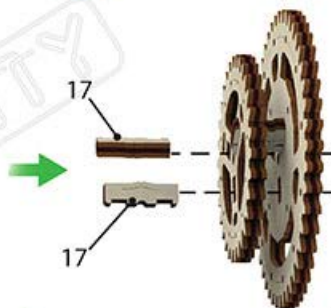

10

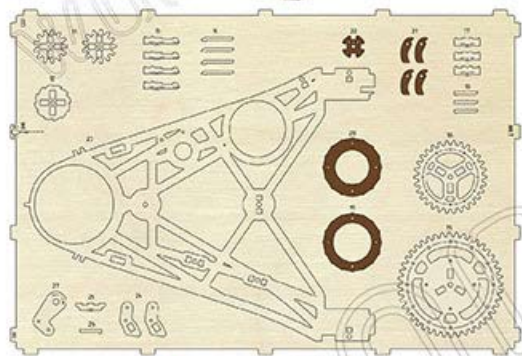
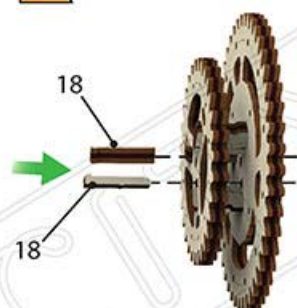

11

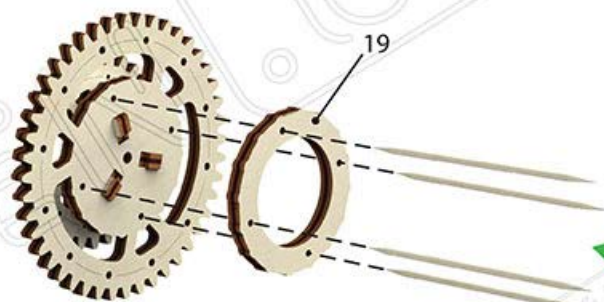

12

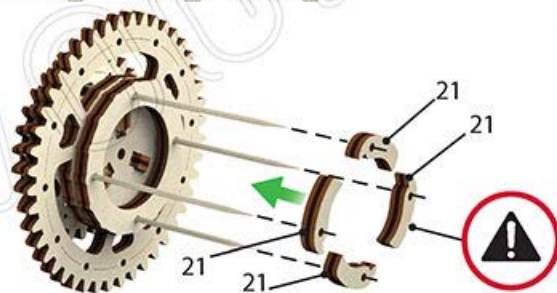

13

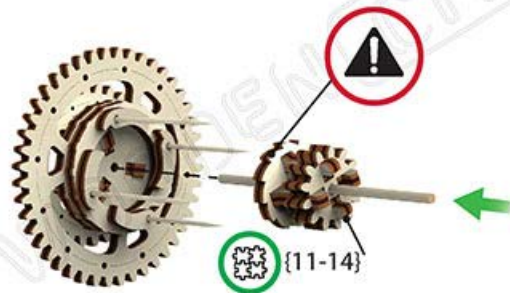

10

{11-14}

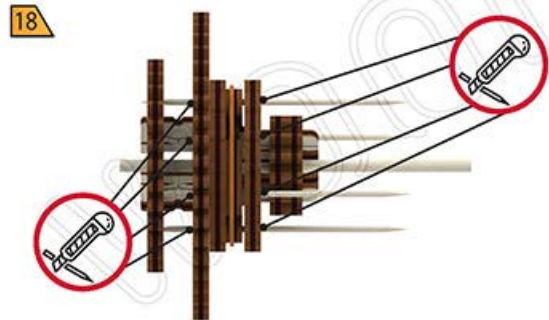
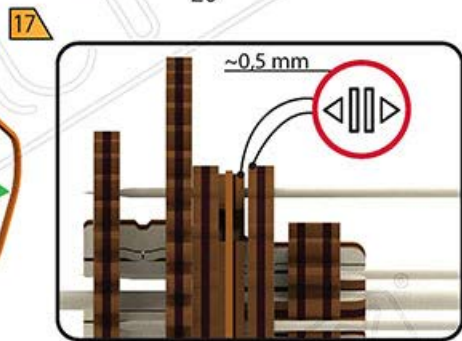
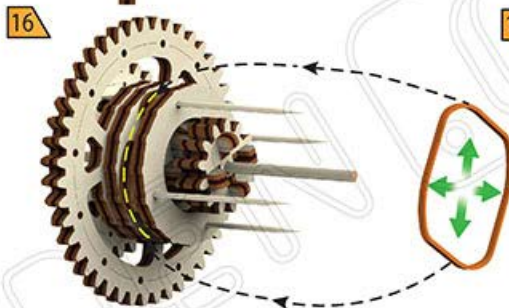
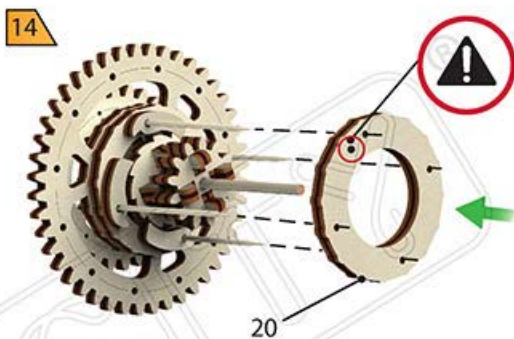
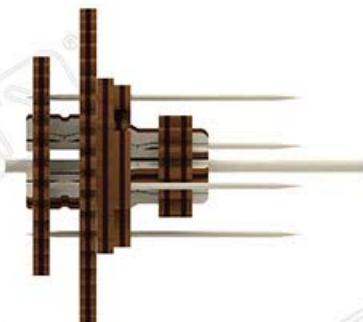

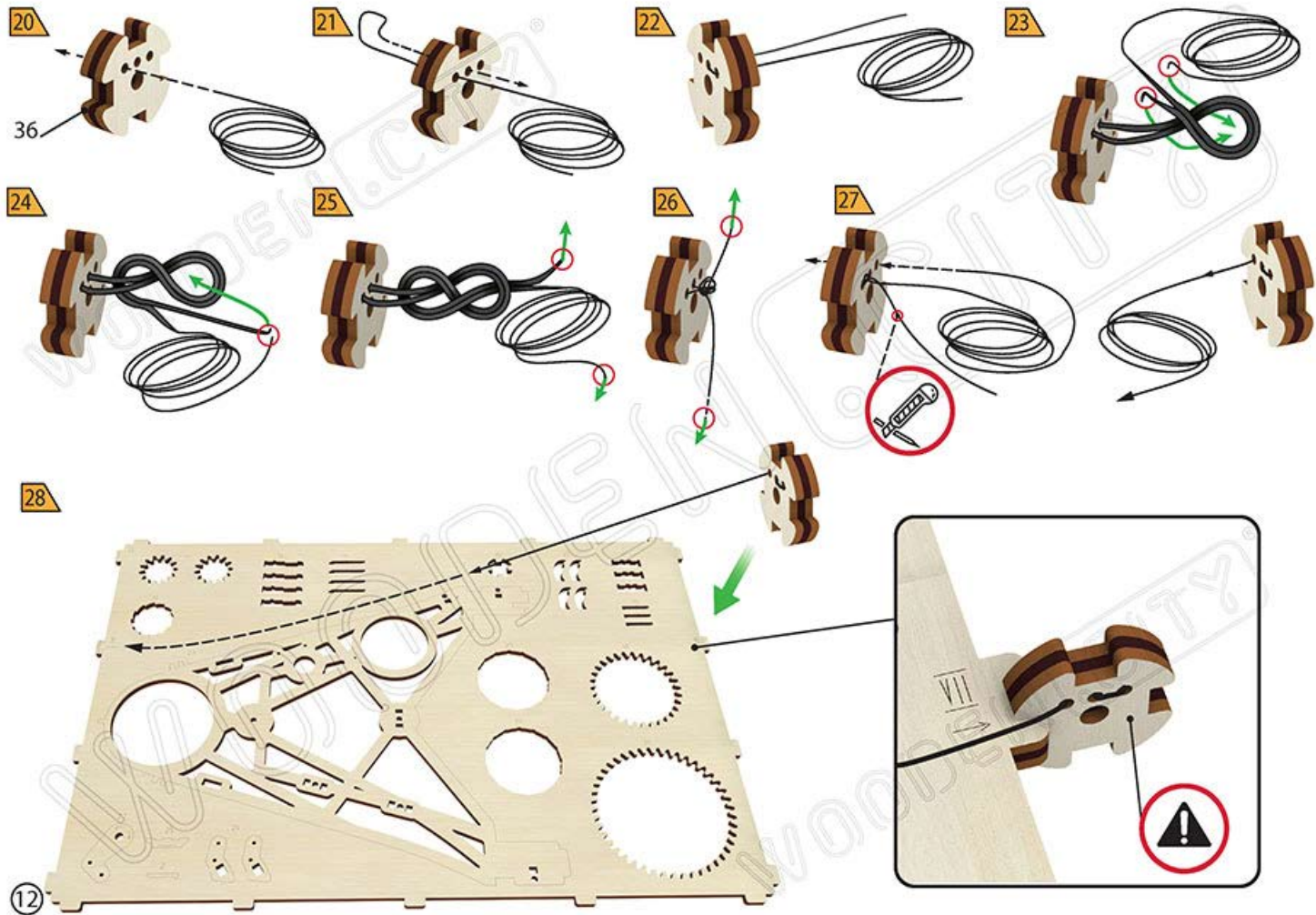

29

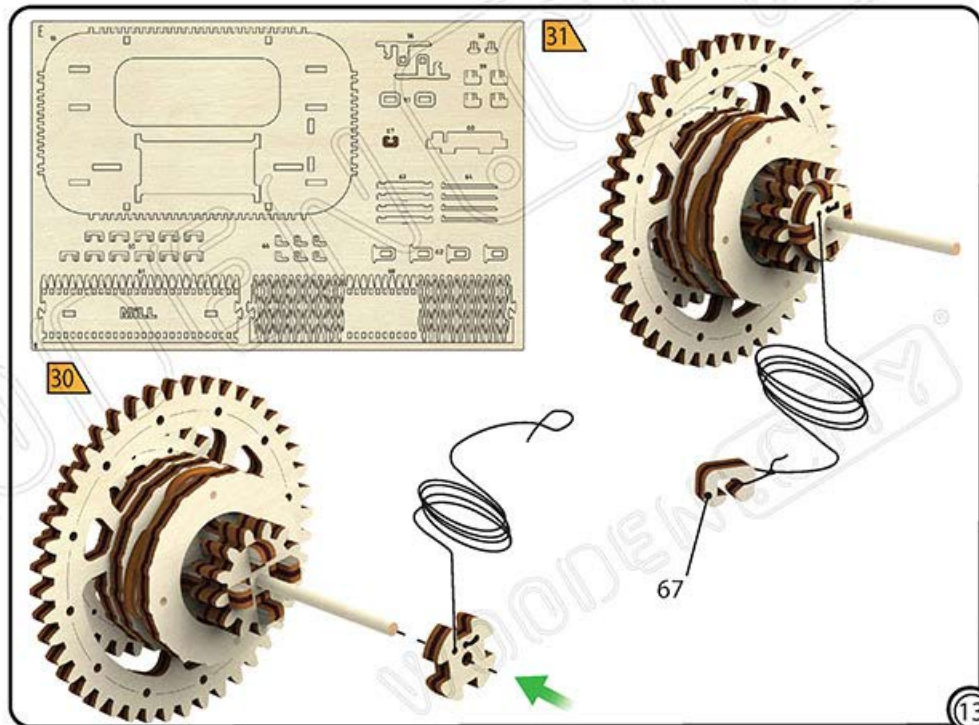
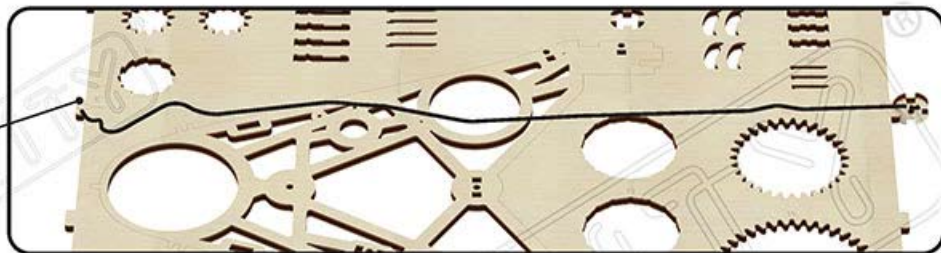
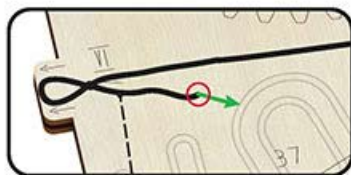
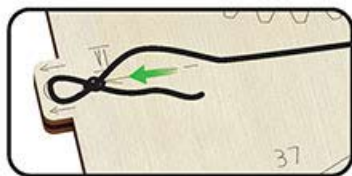
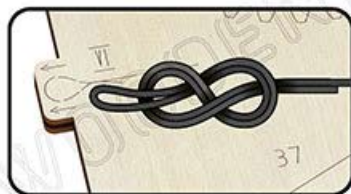
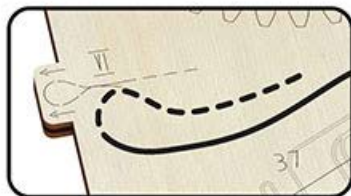



1



2

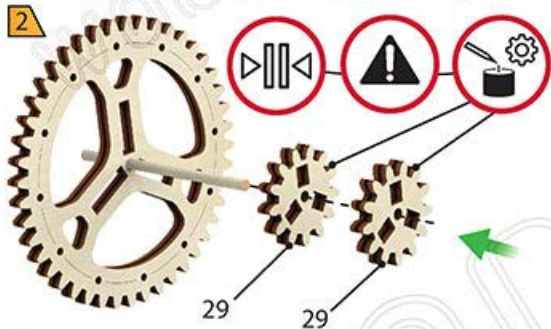

3

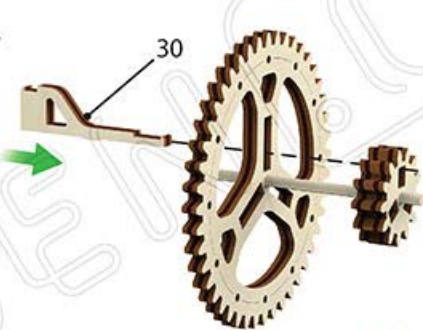

4

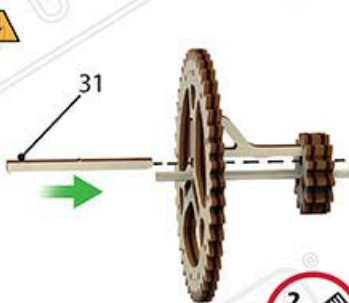

5

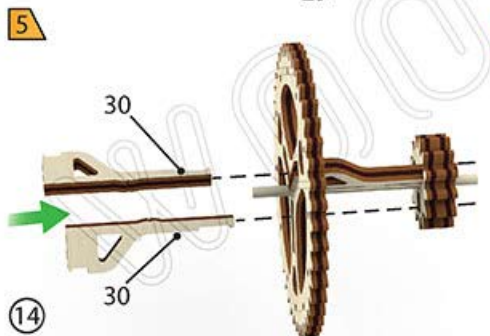

6

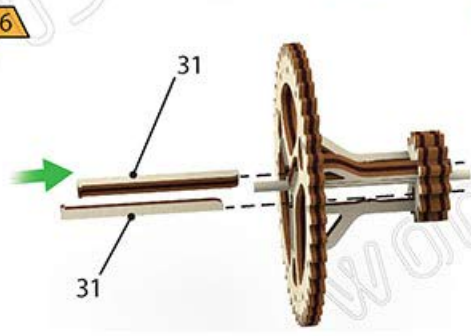

7

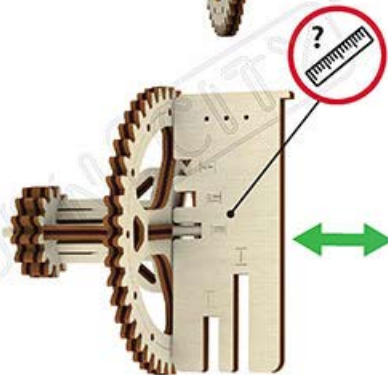

14

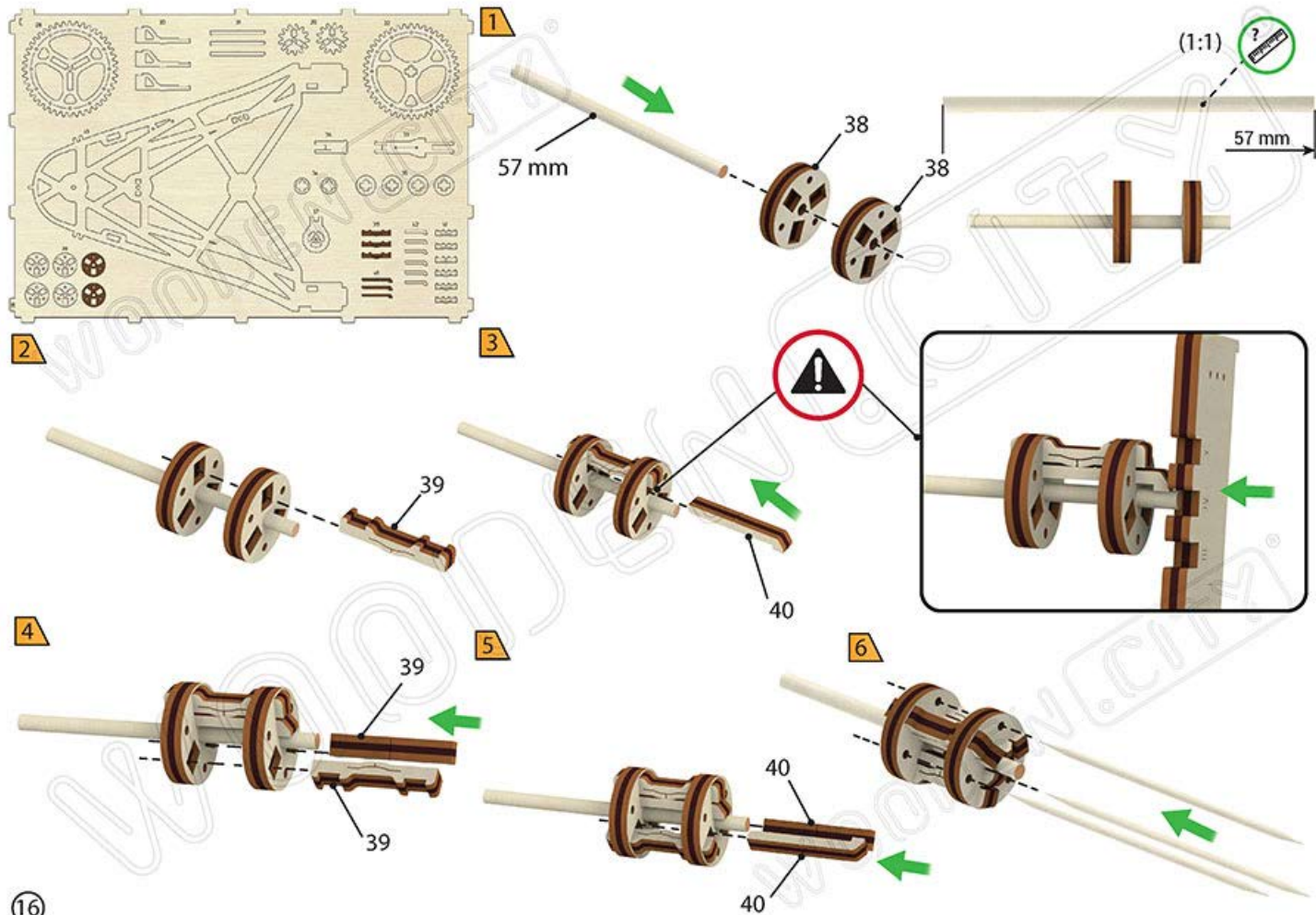

7



8

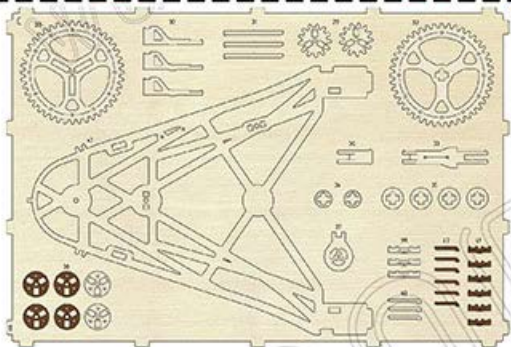
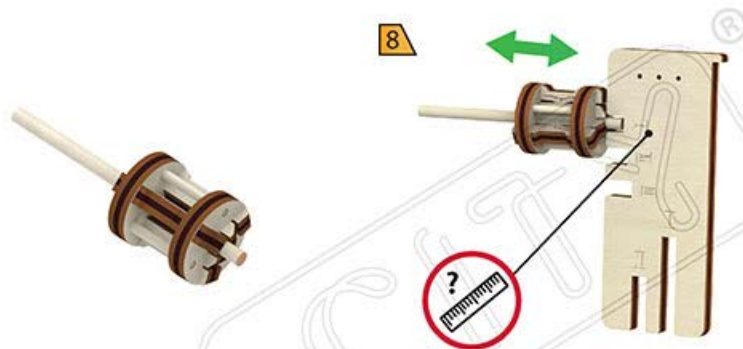

1

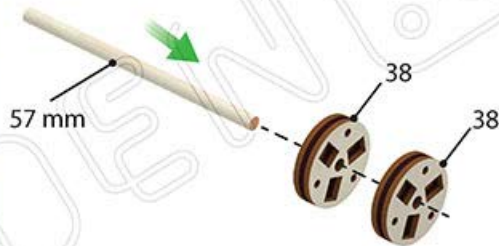

(1:1)



57 mm

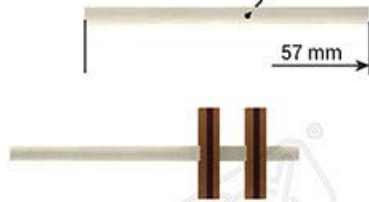

2

3

4



17

5



6



7



8



84 mm

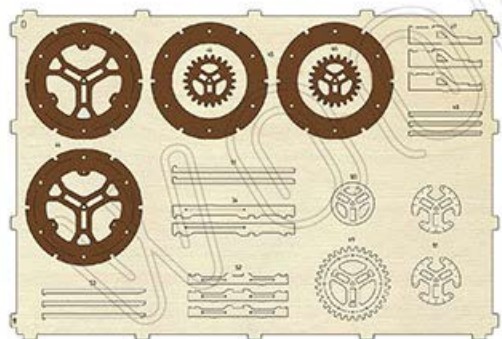

1

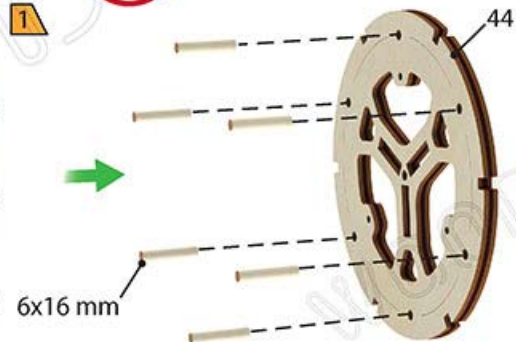

6x16 mm

44

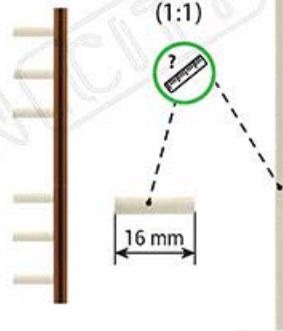

(1:1)

16 mm

18

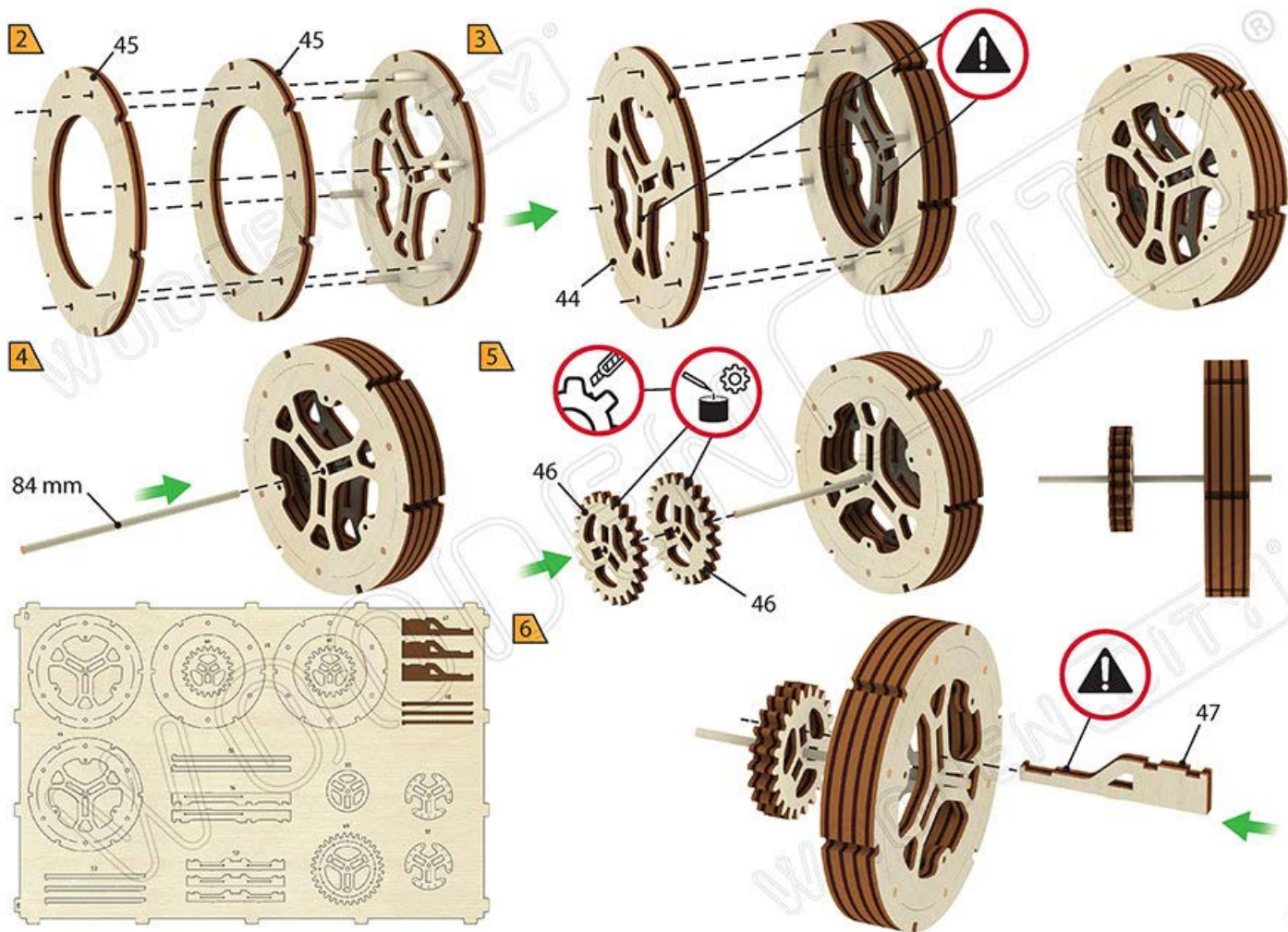

7

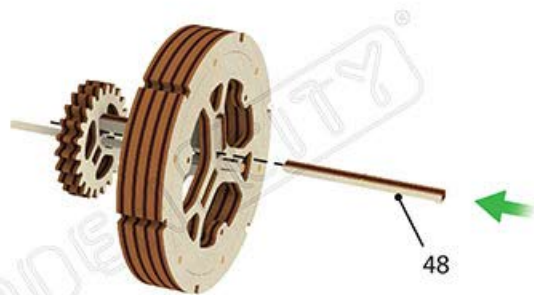

8

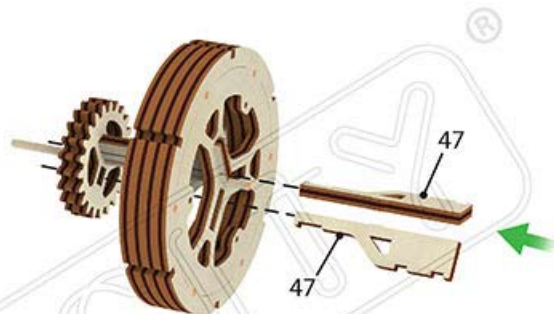

9

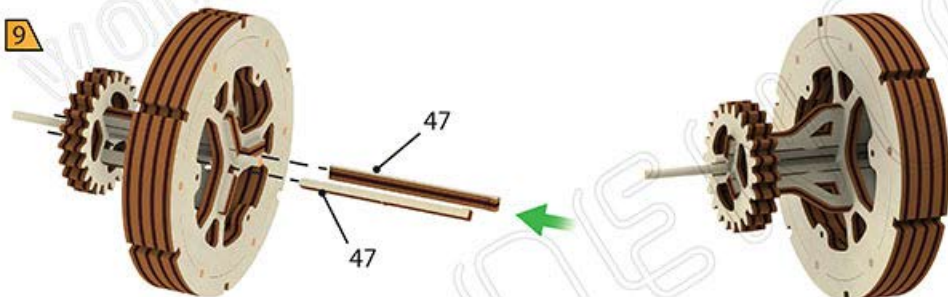

10

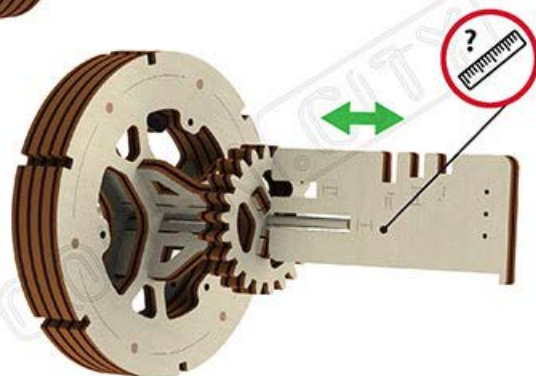

20

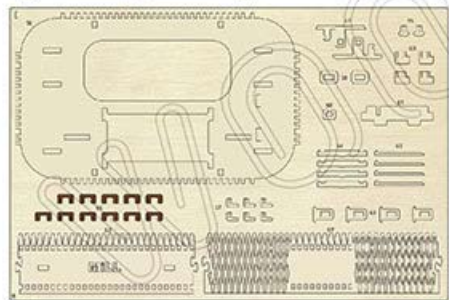
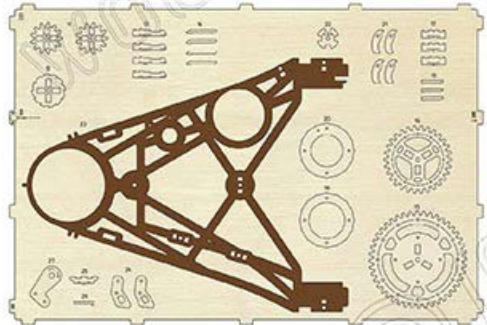
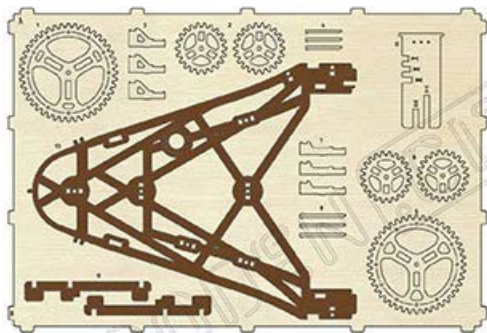

21

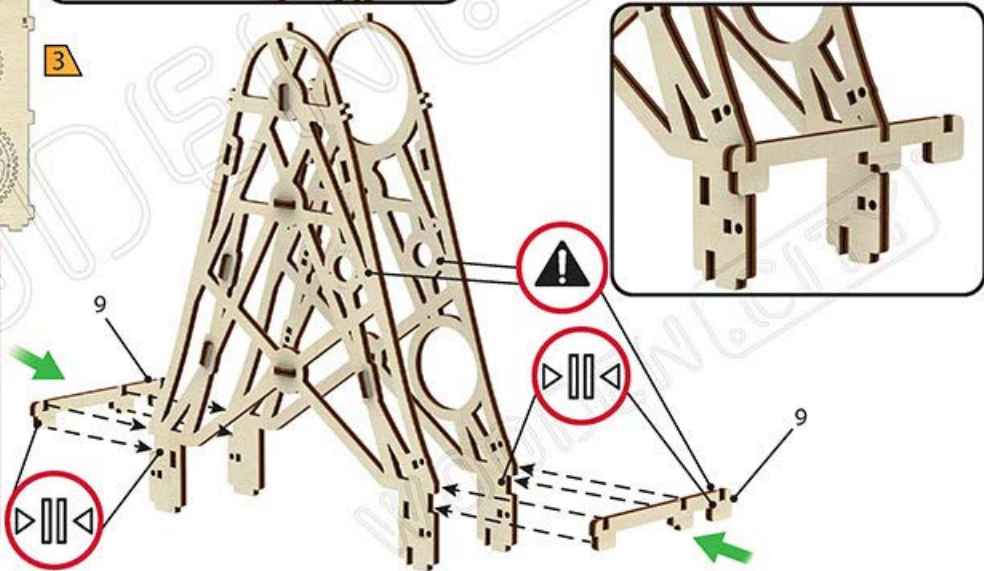
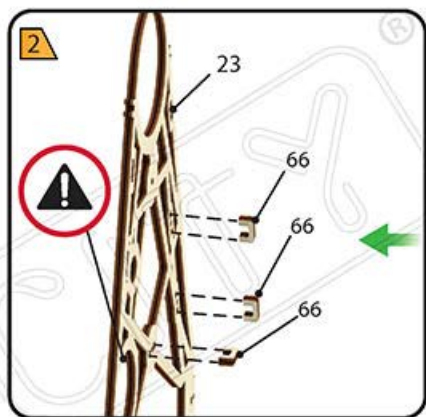

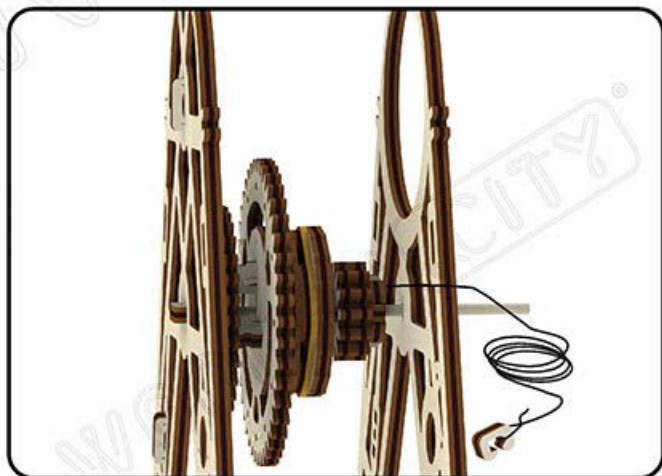
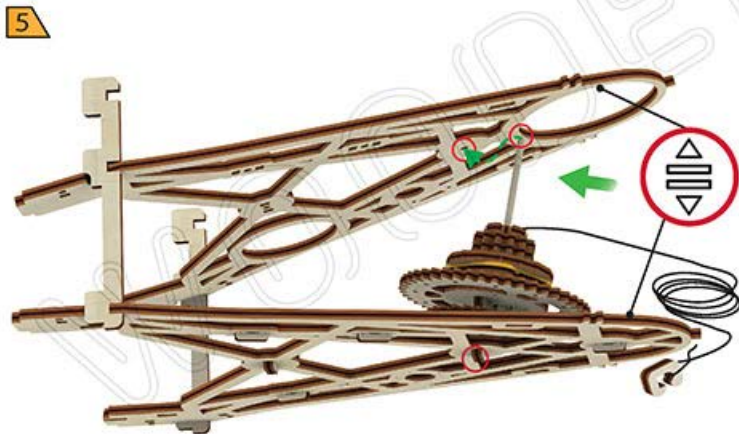
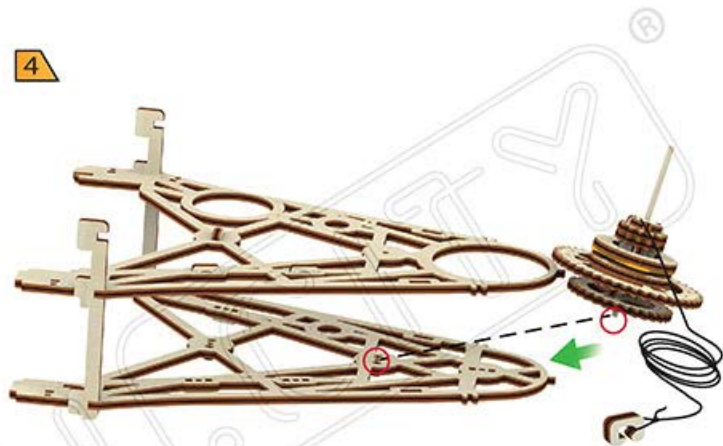
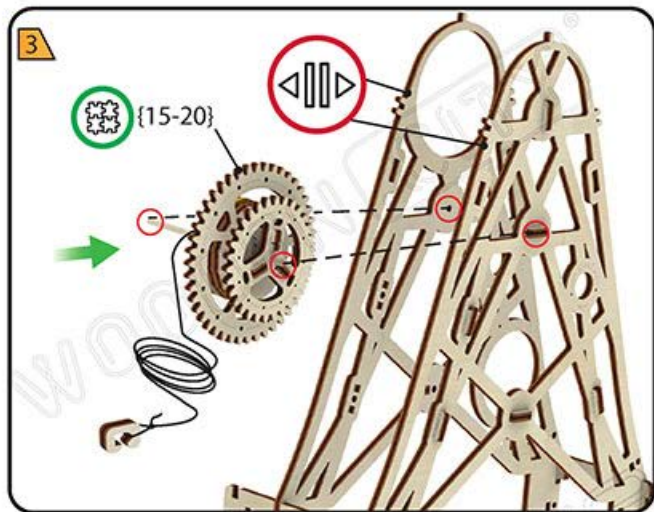

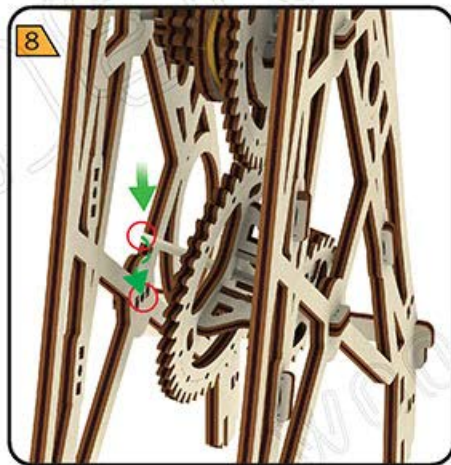
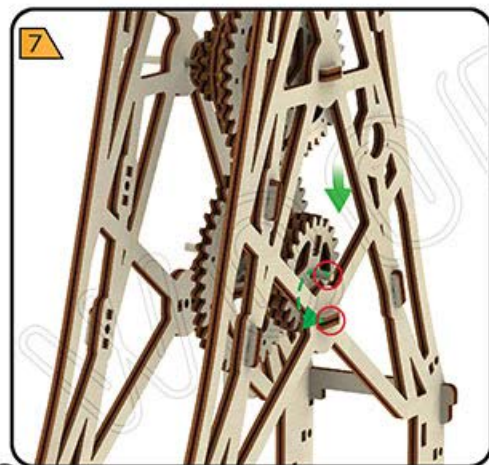
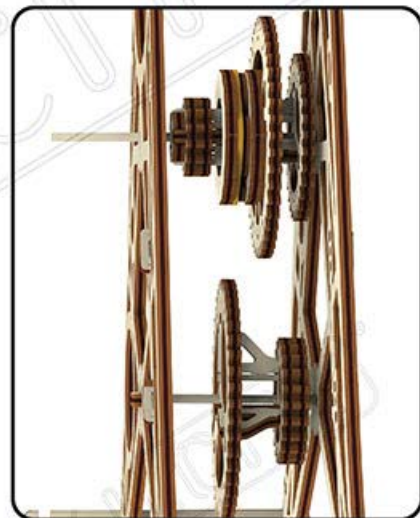
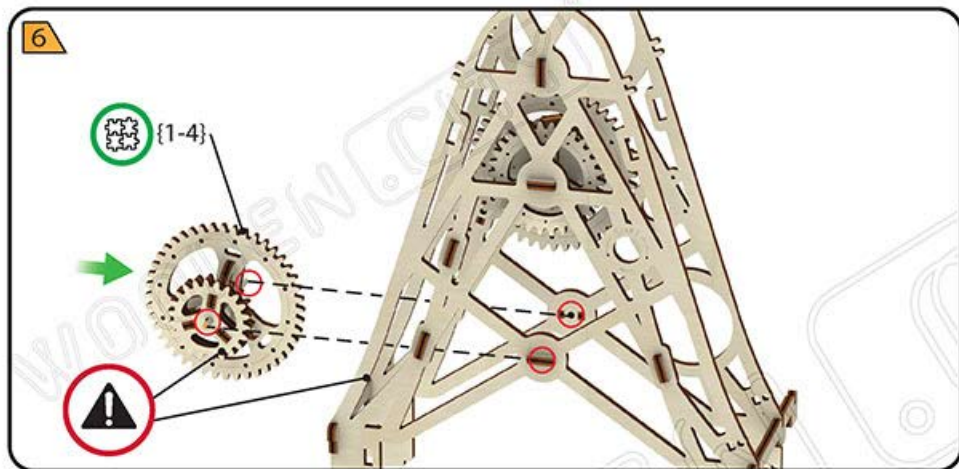

9

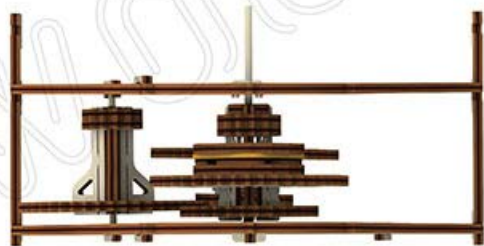

10

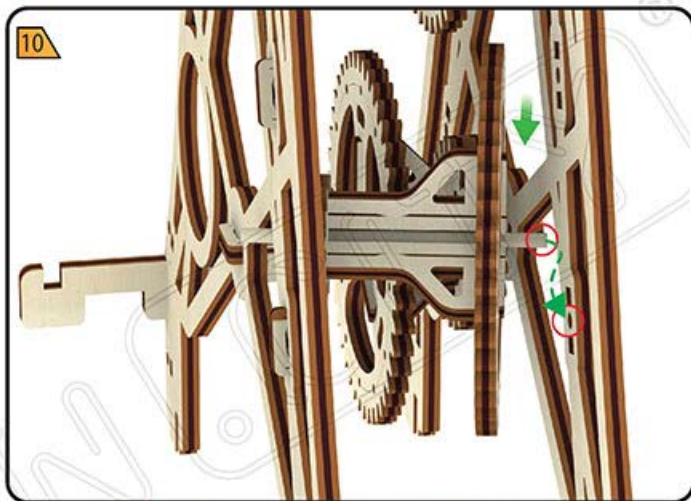

11

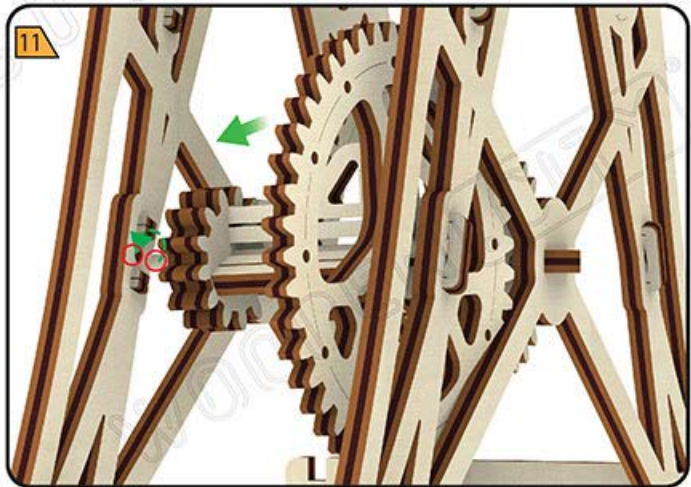

12

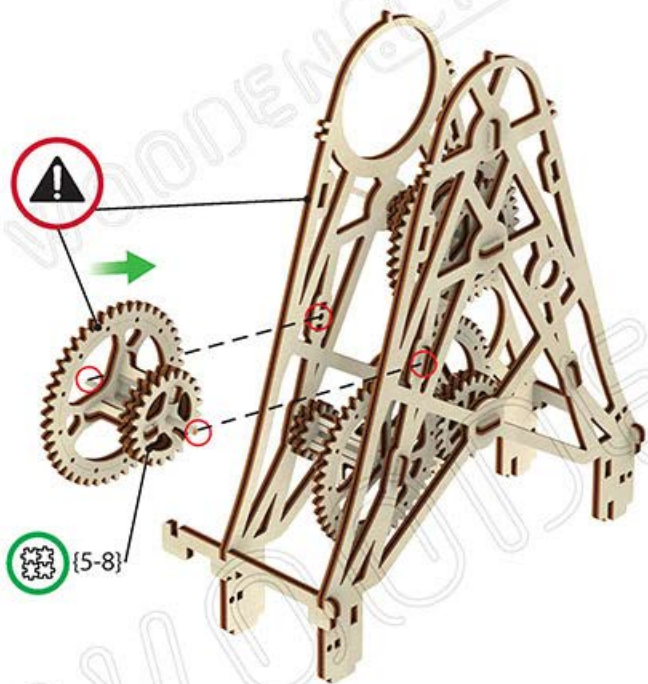

13



14

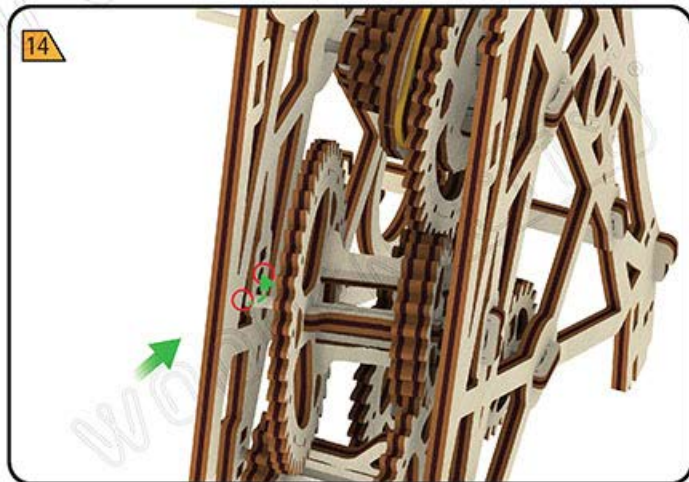

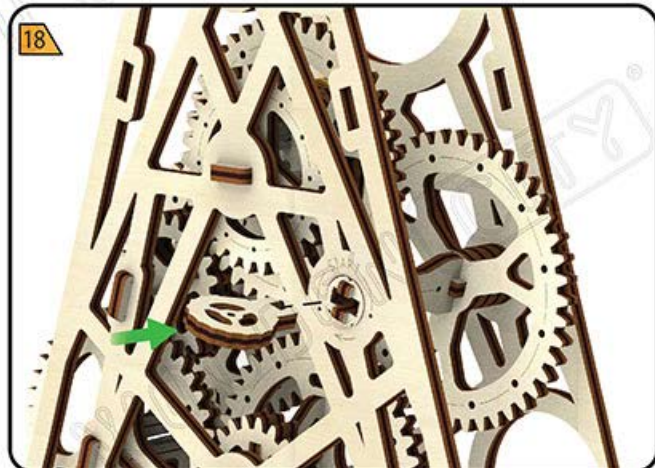
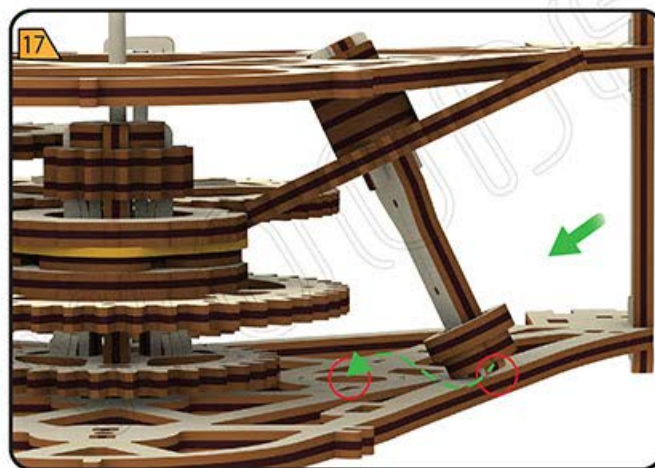
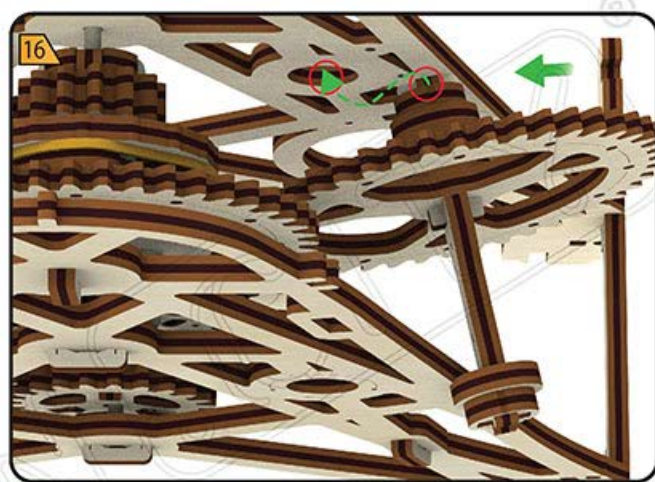
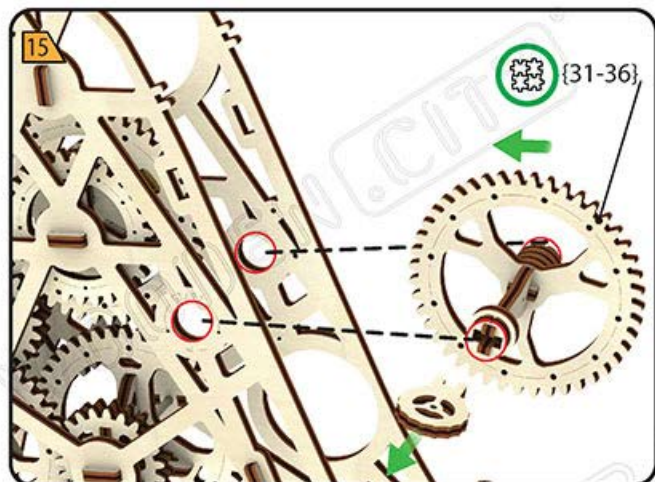

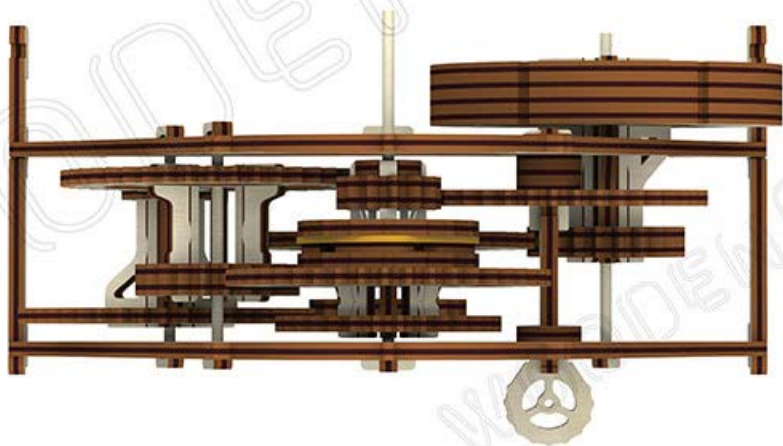
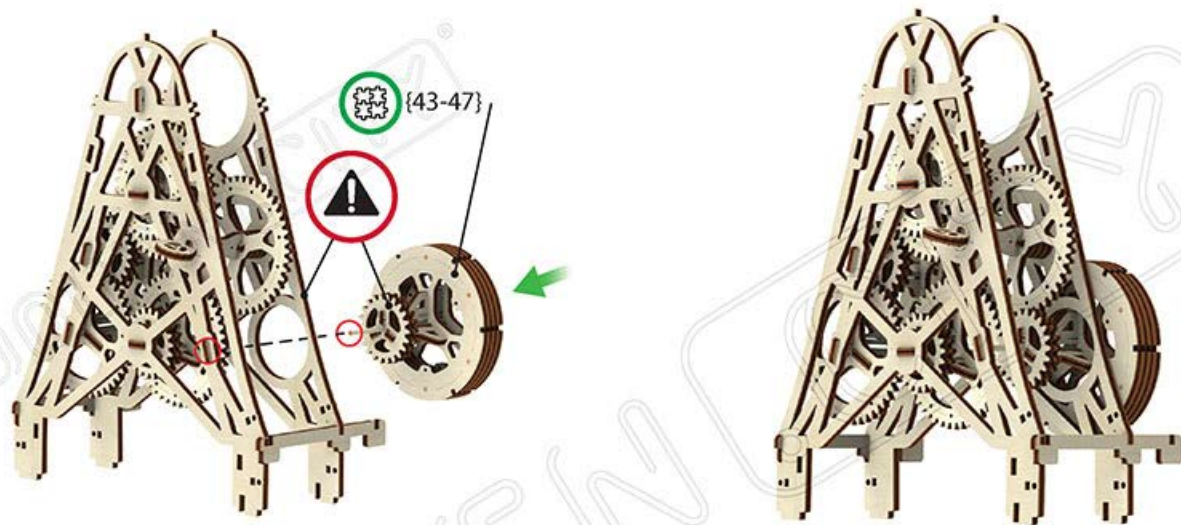

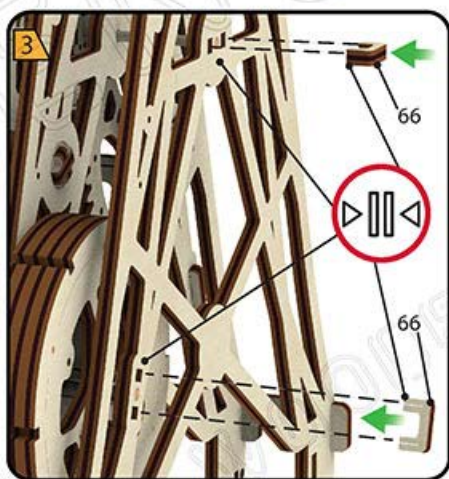
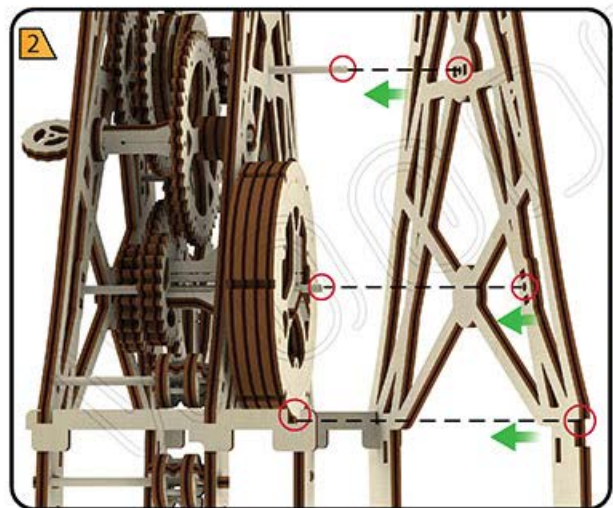
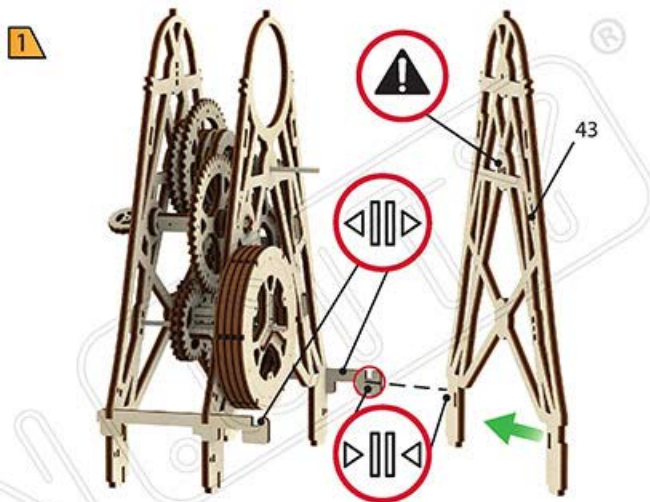
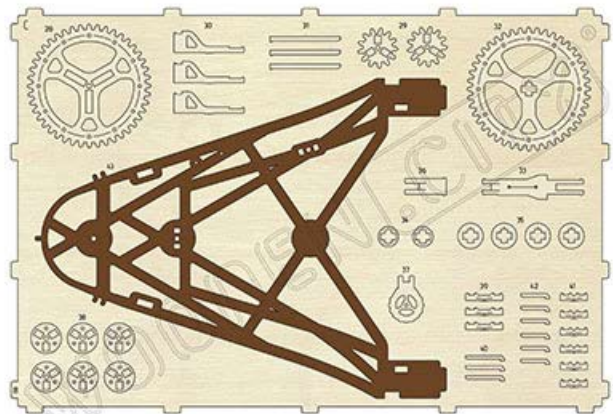

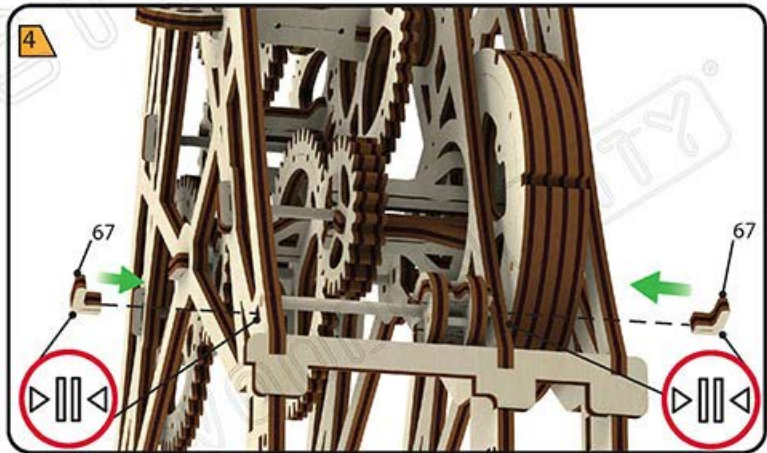
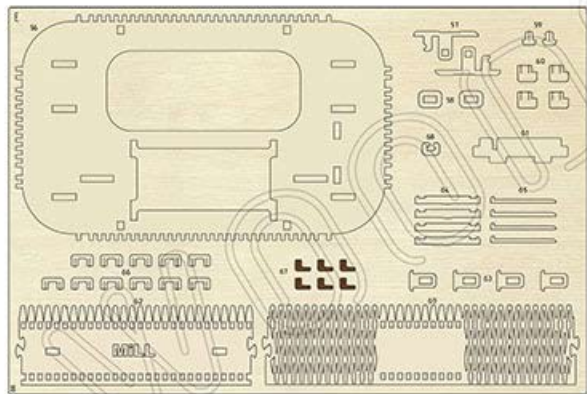
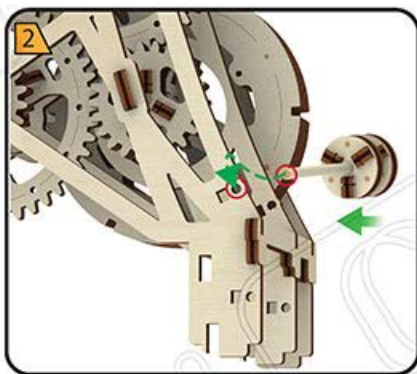
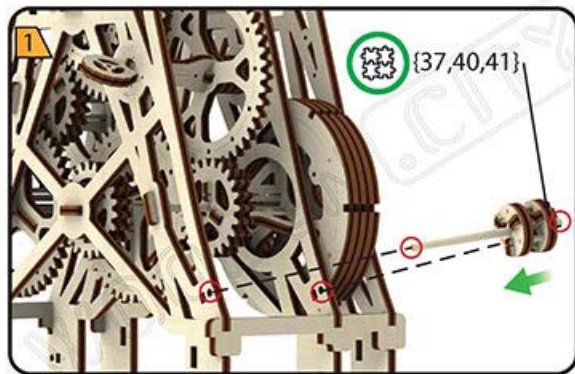

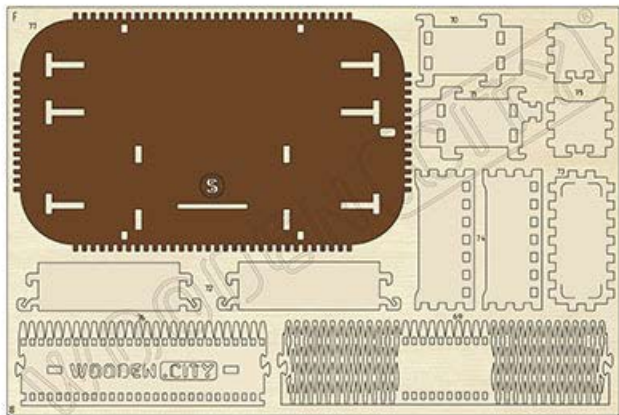

1

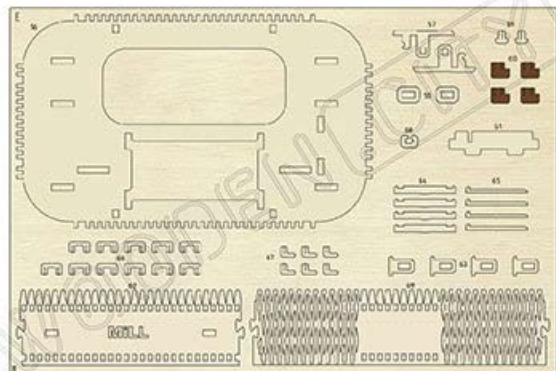
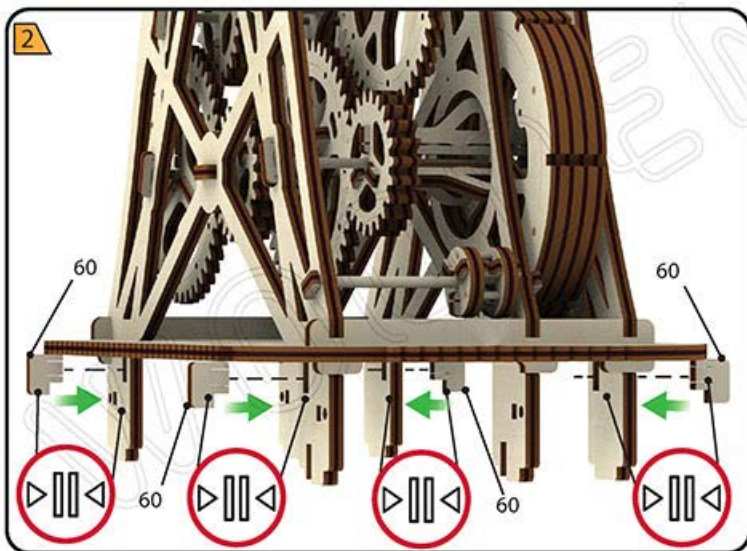
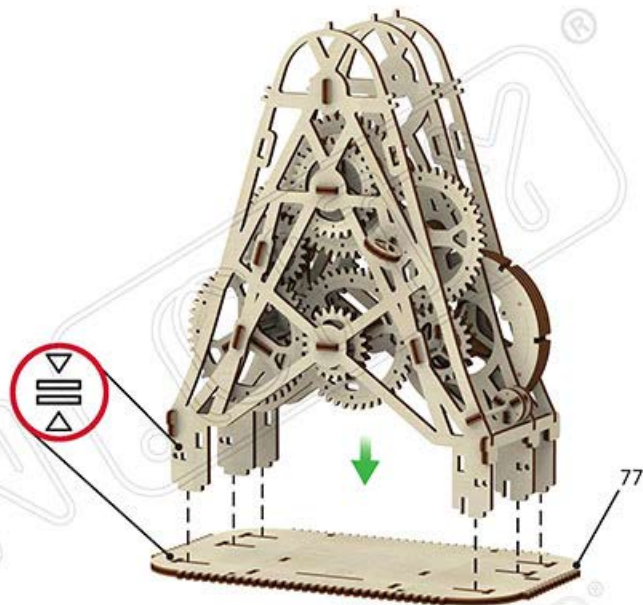

30

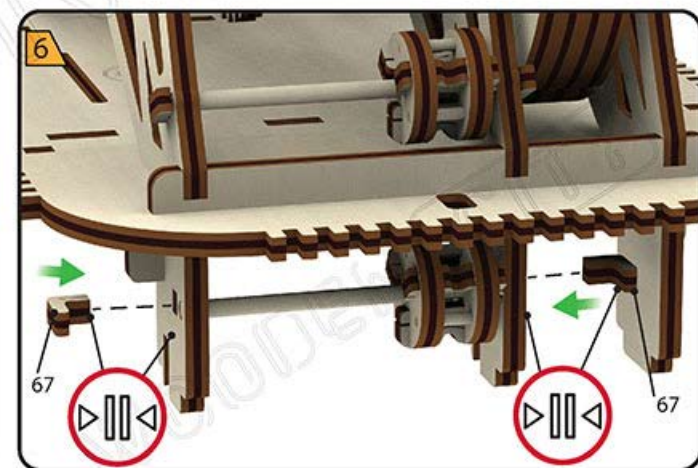
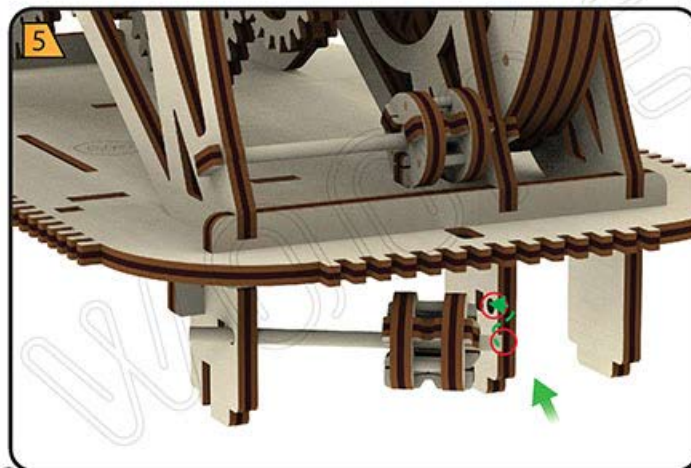
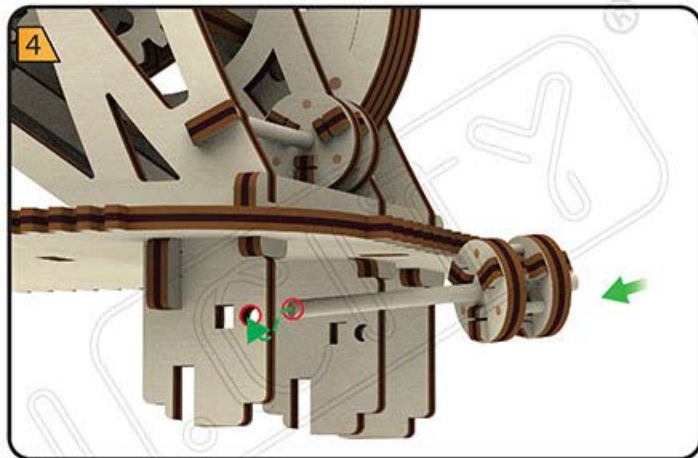
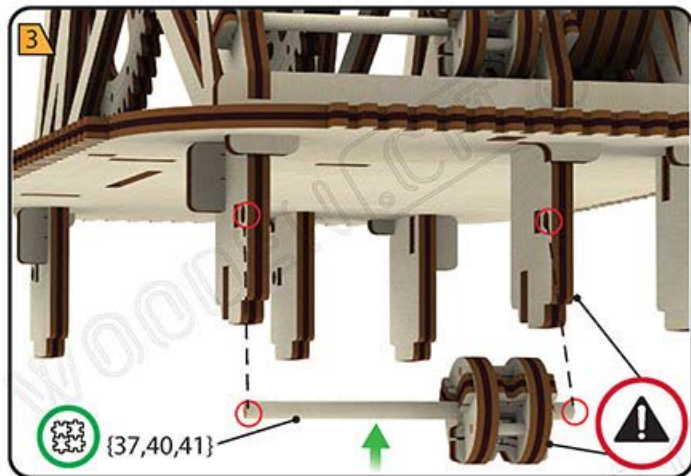

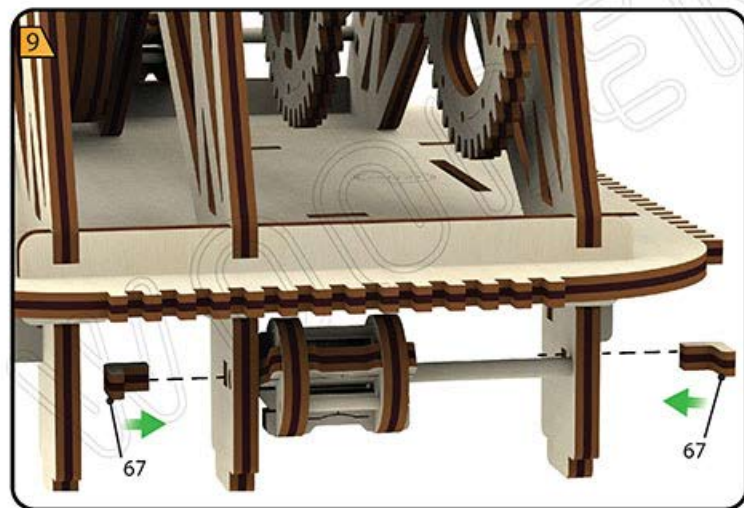
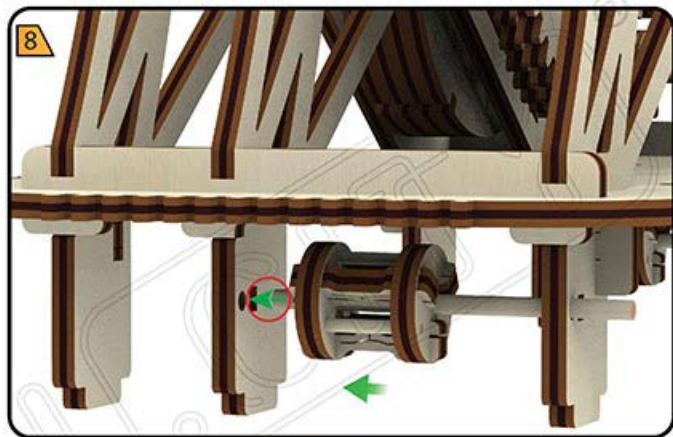
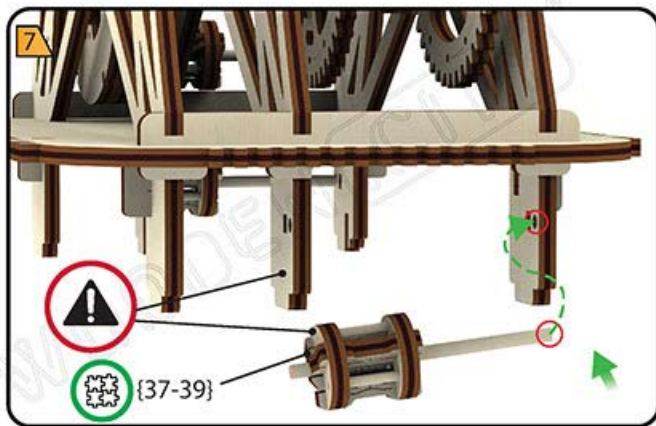

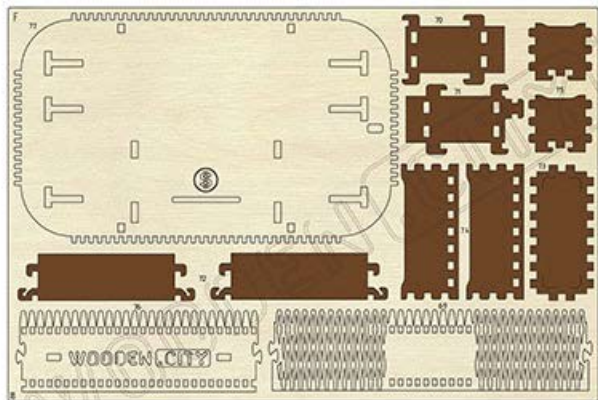

1

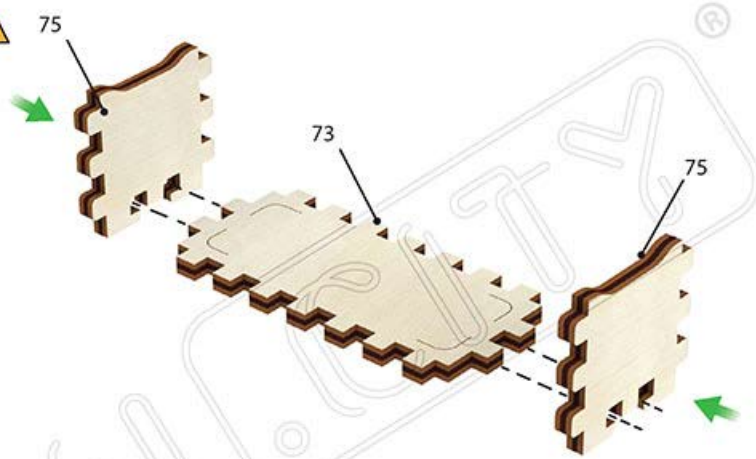

2

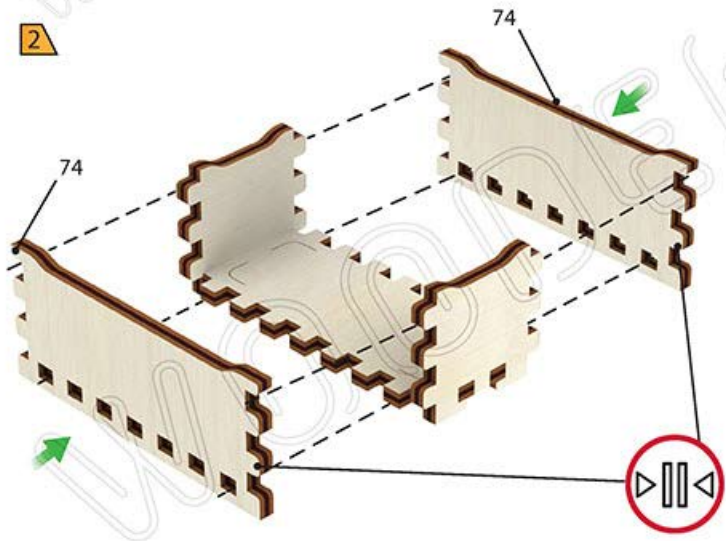

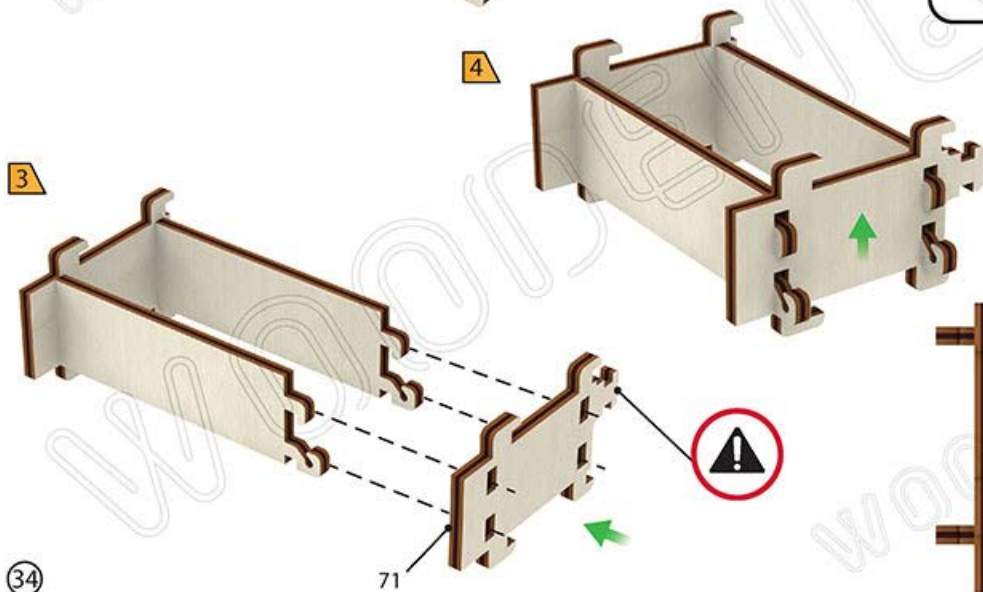
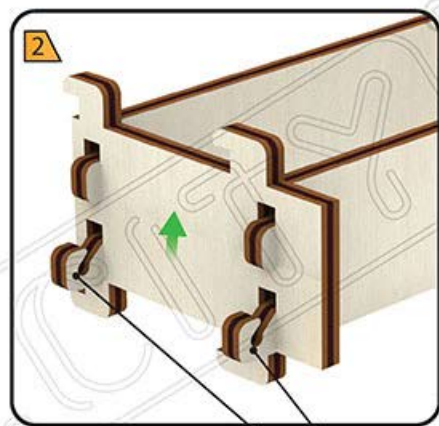
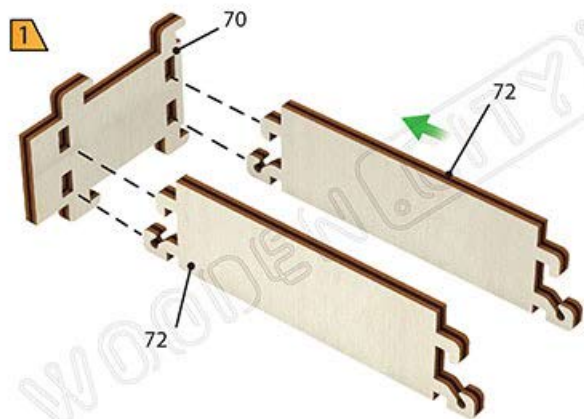

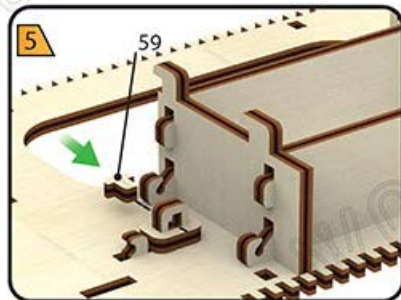
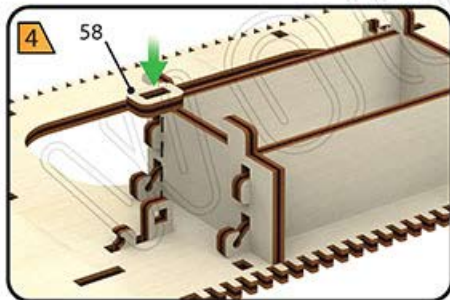
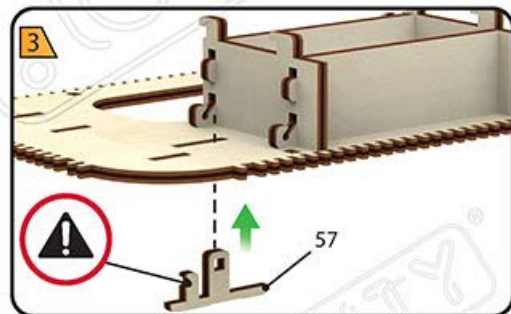
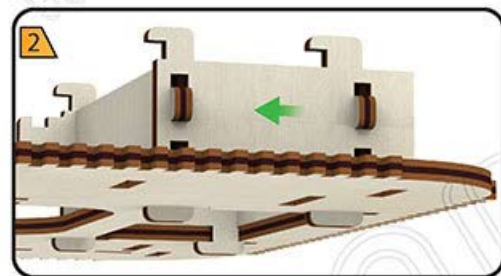
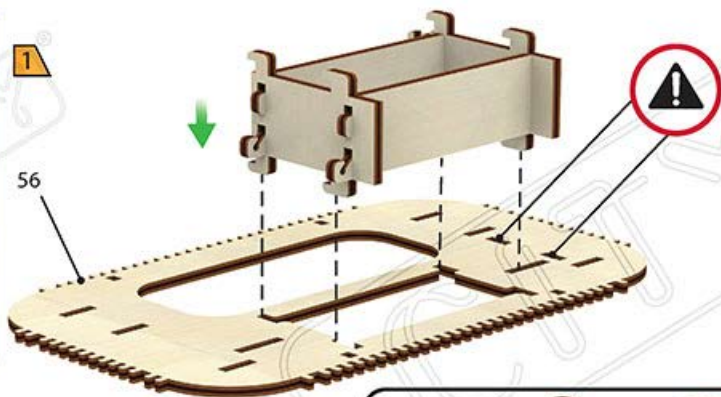
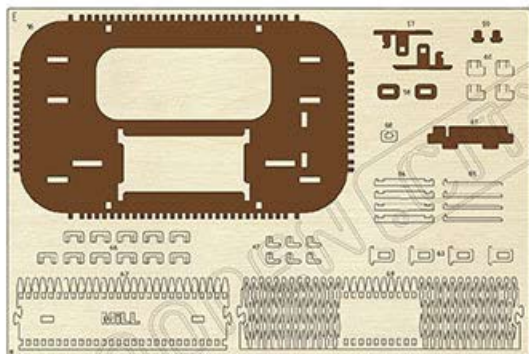

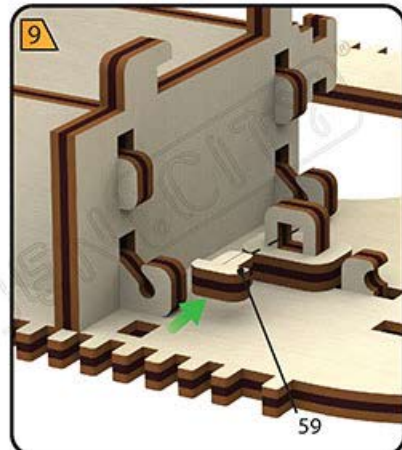
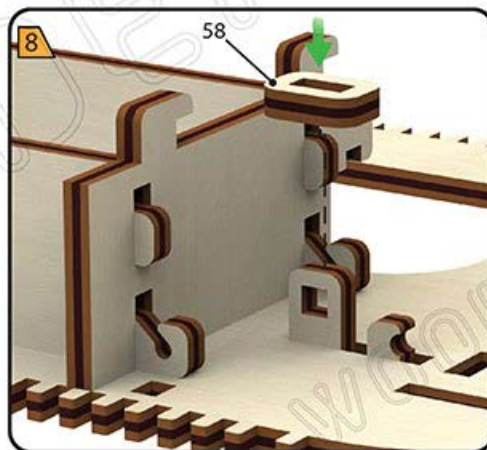
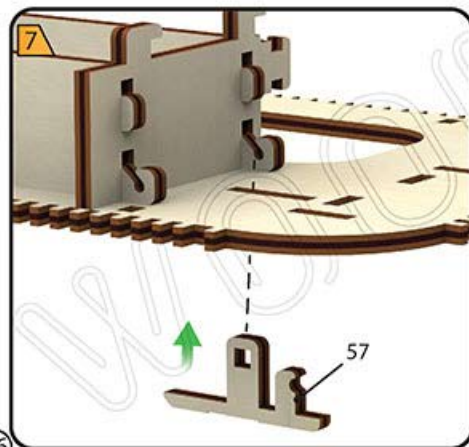
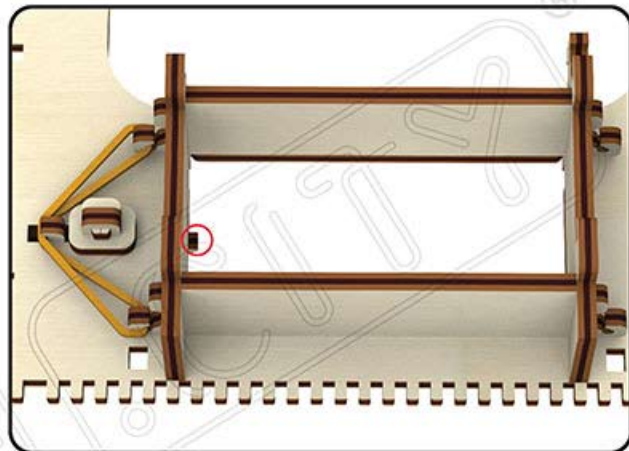
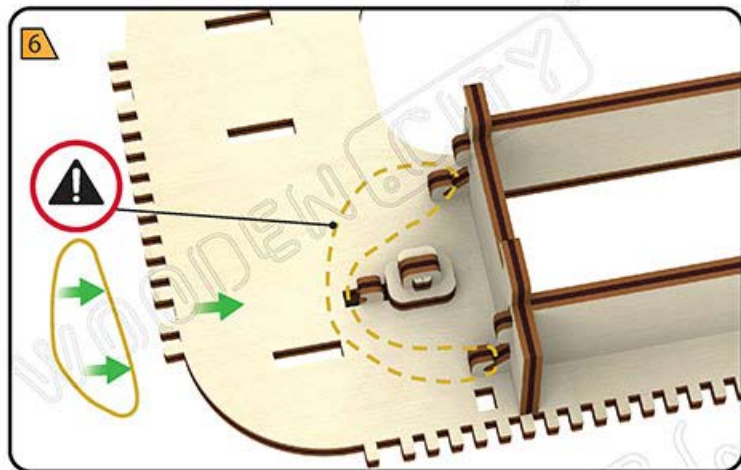

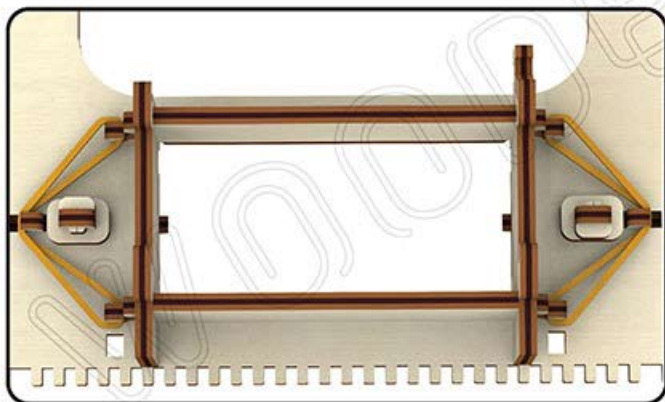
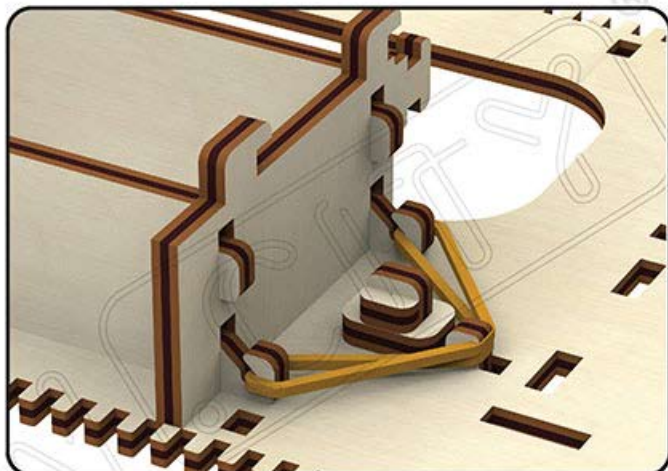
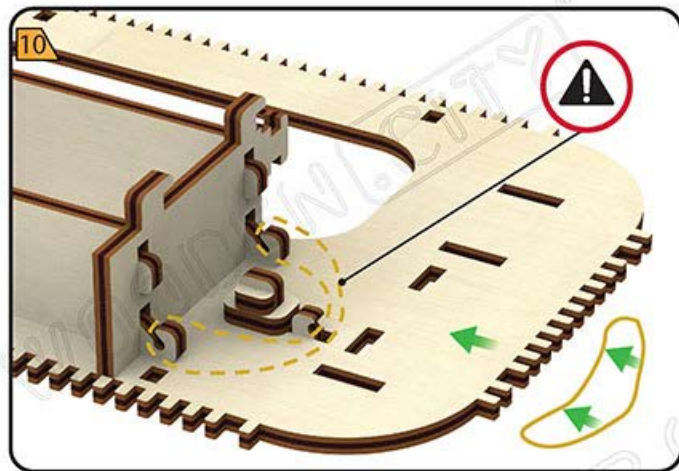

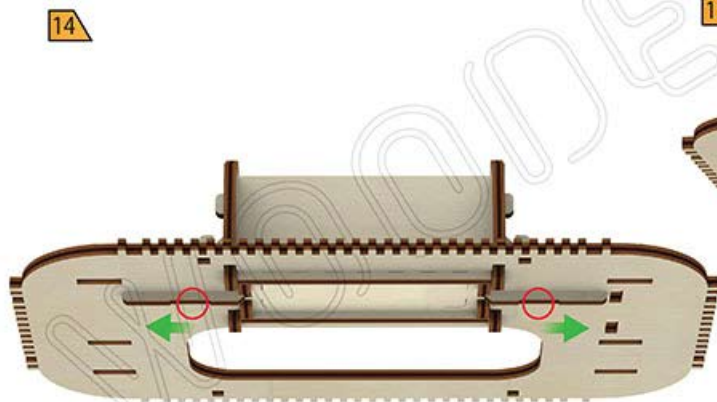
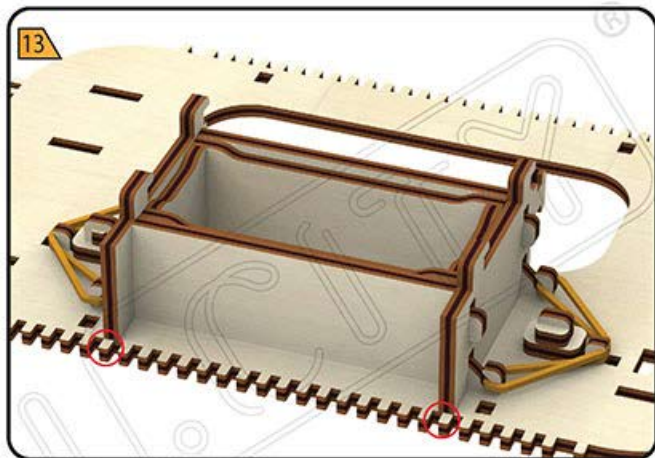

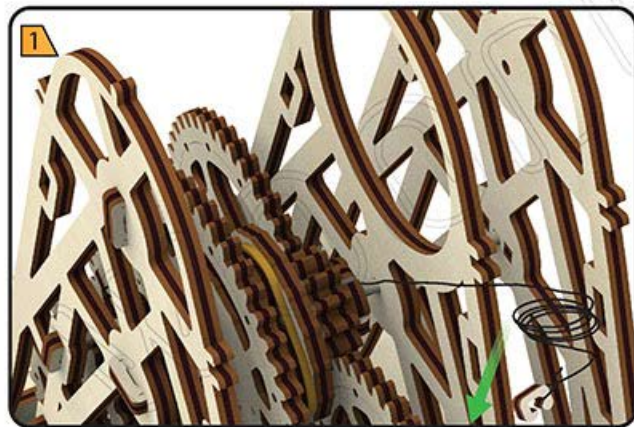
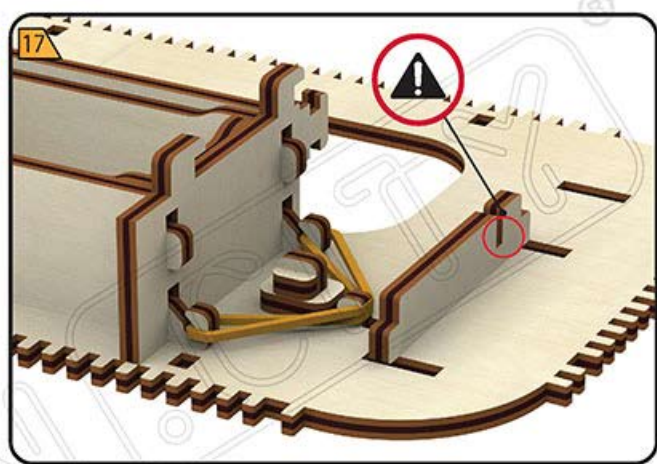
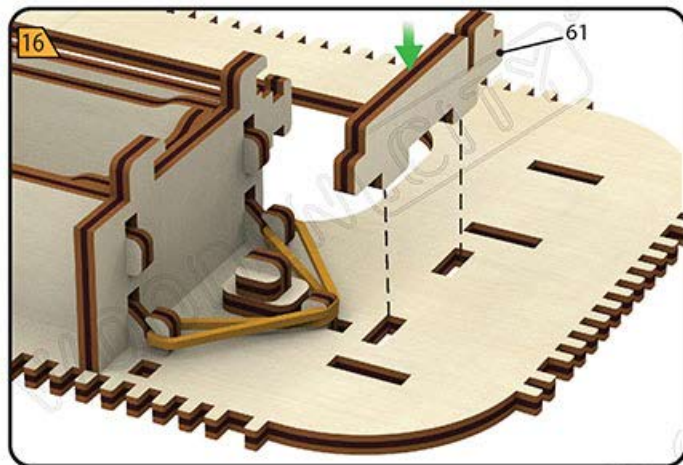

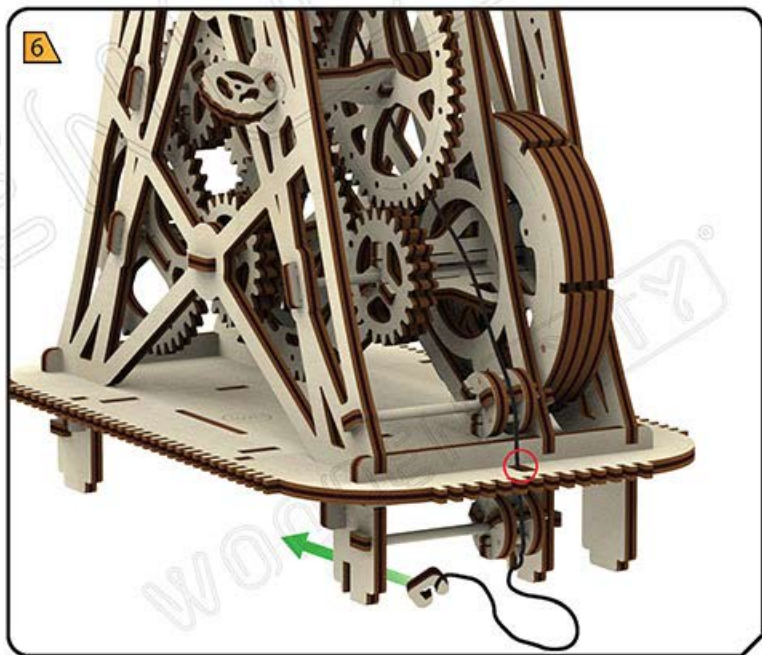
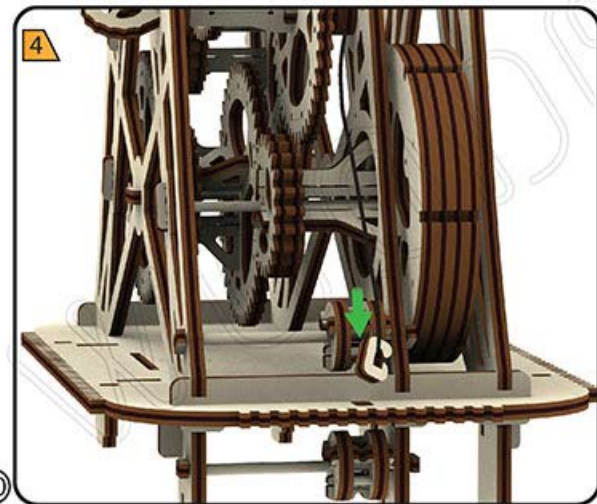
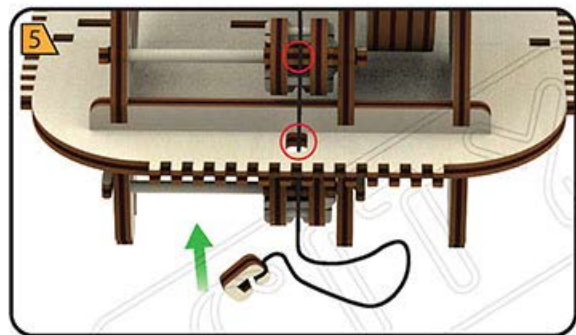
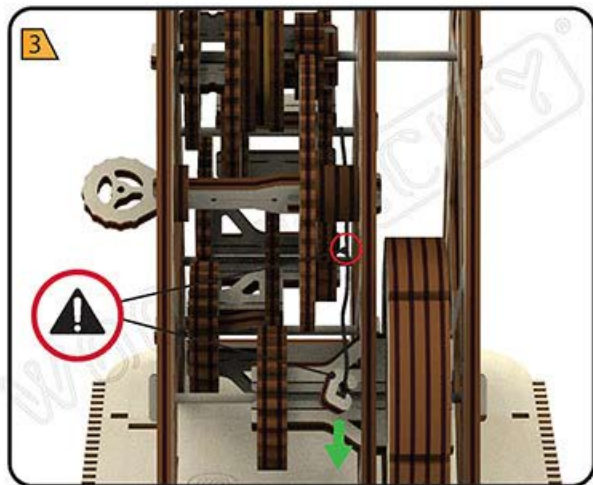

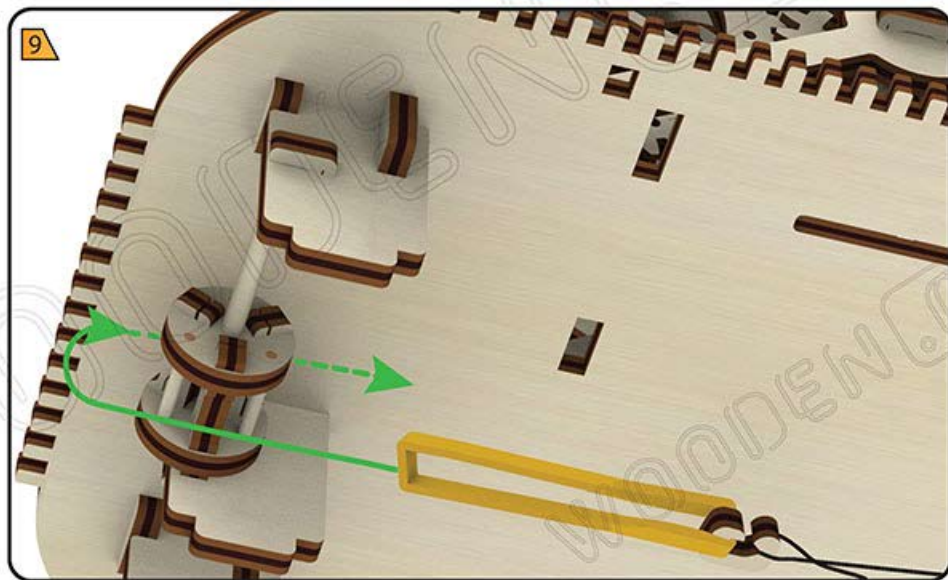
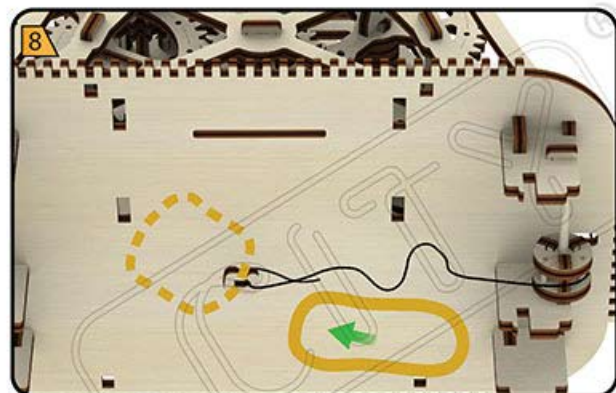
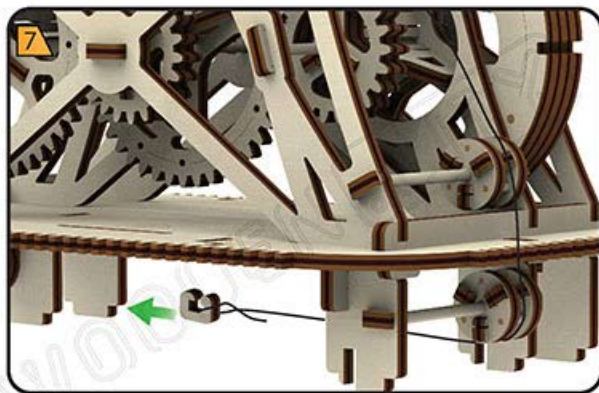

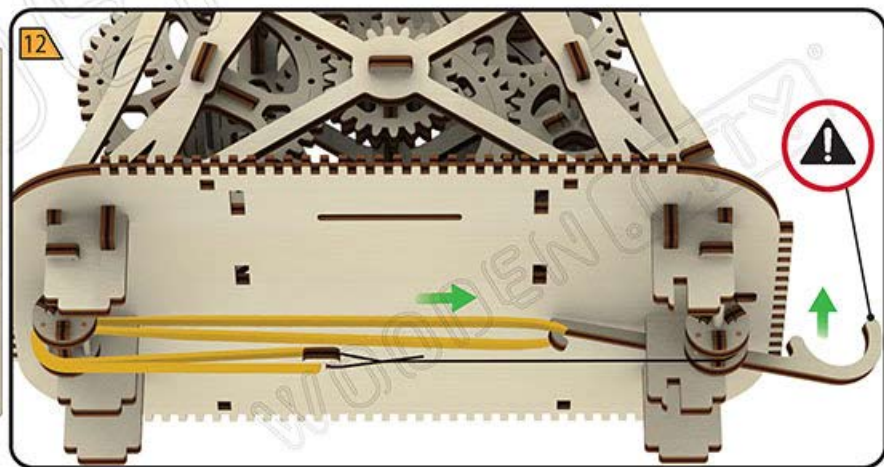
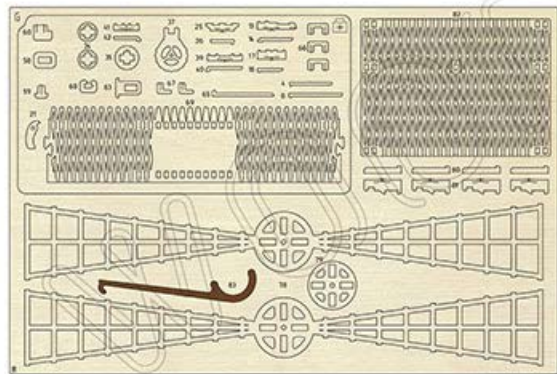
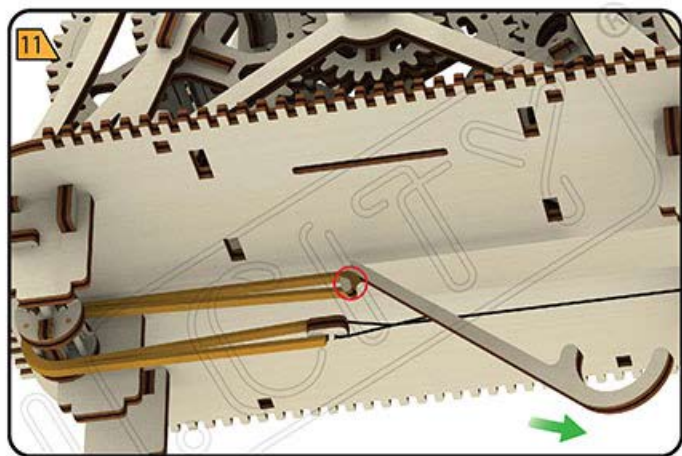
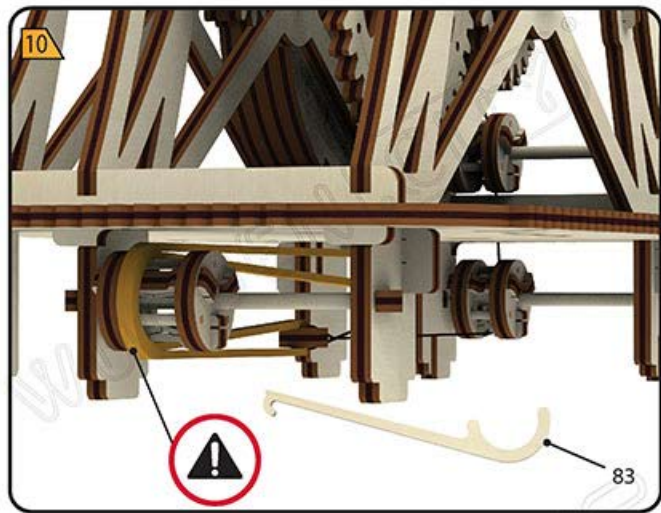

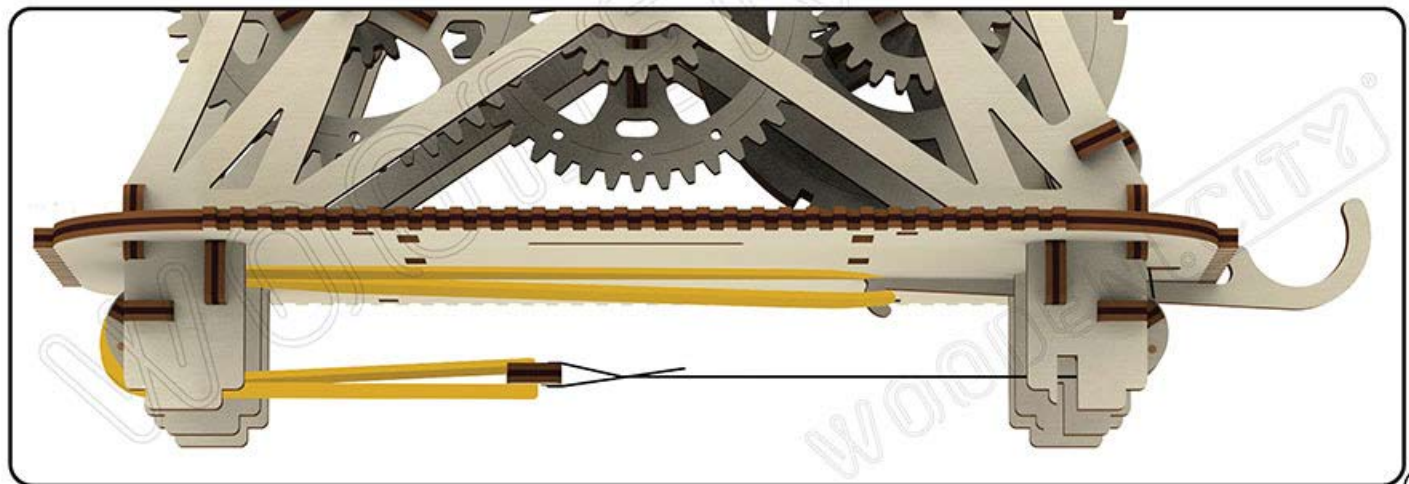
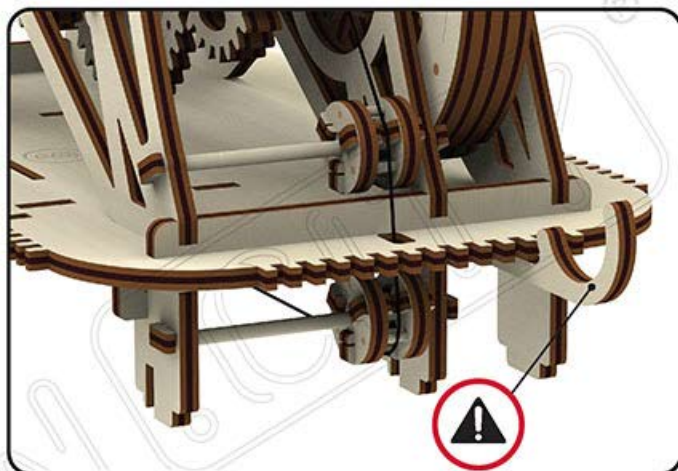
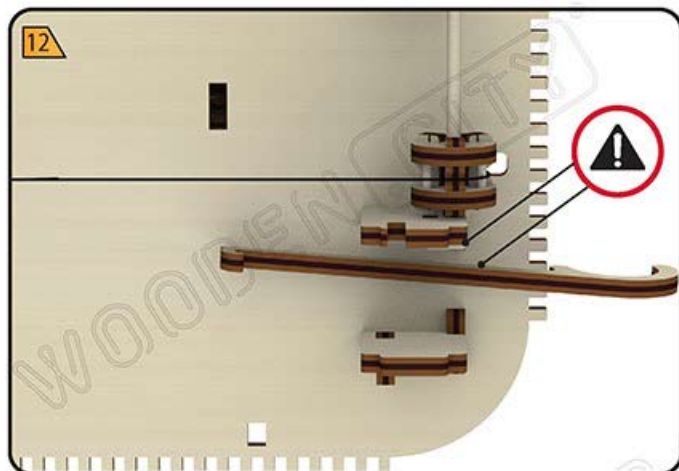

1

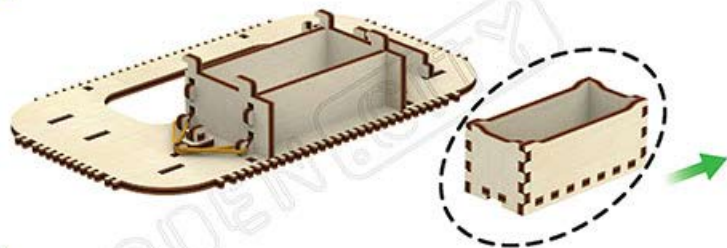

2

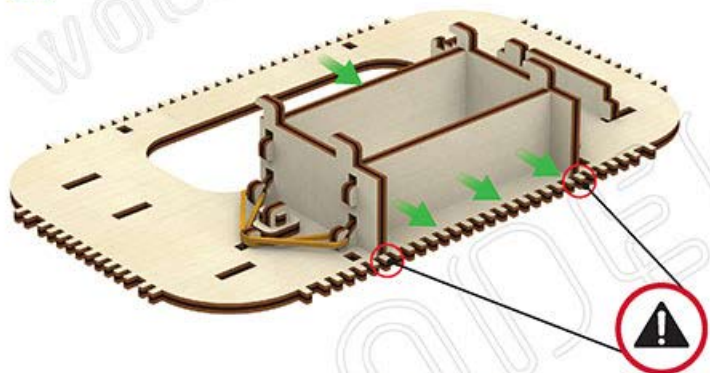

3

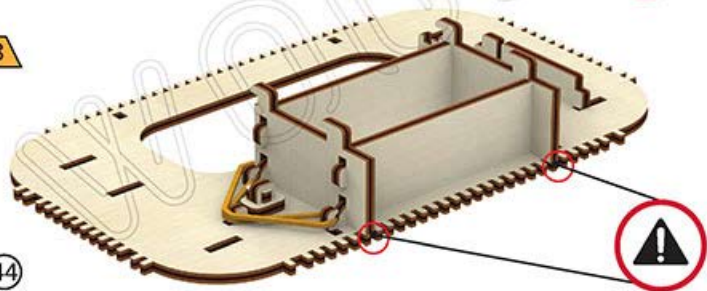

44

4

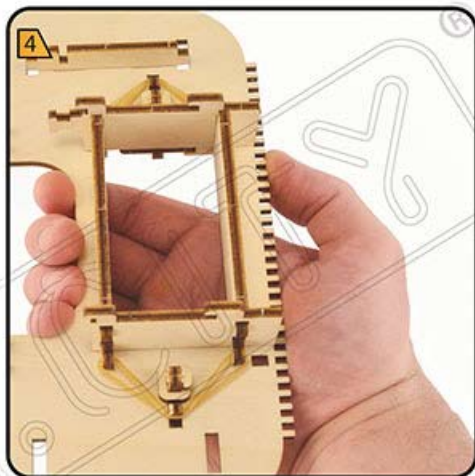

5

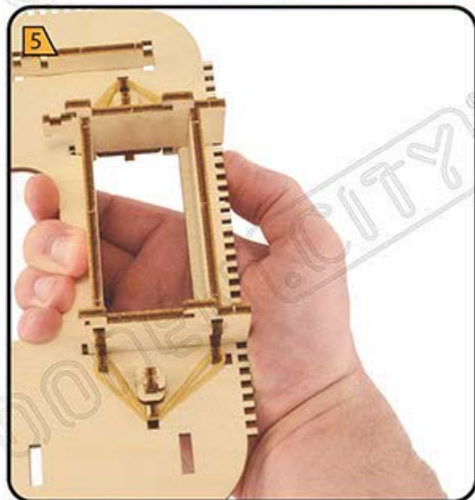

1

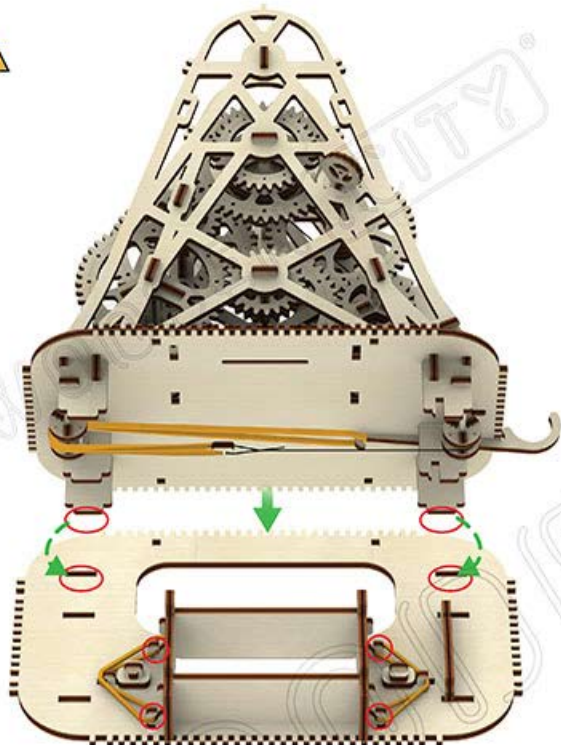

2

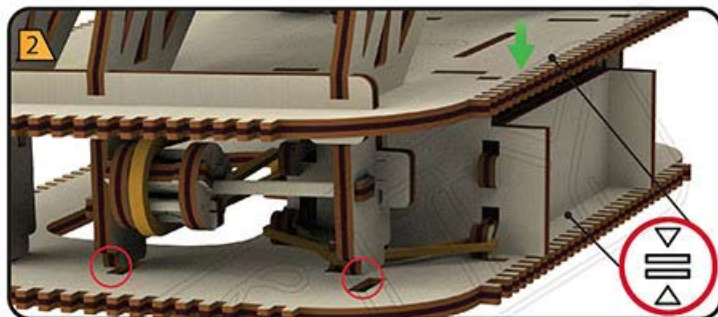

3

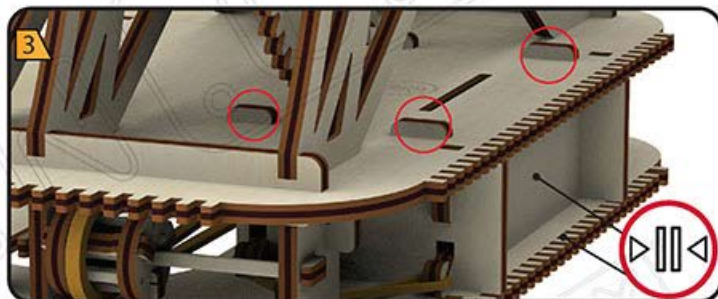

4

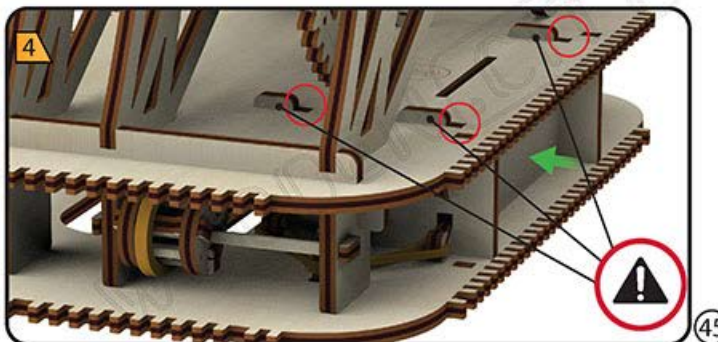

5

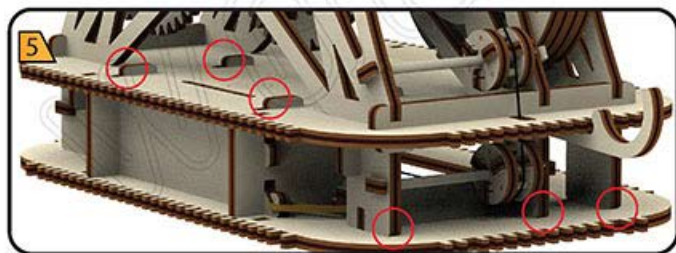



6

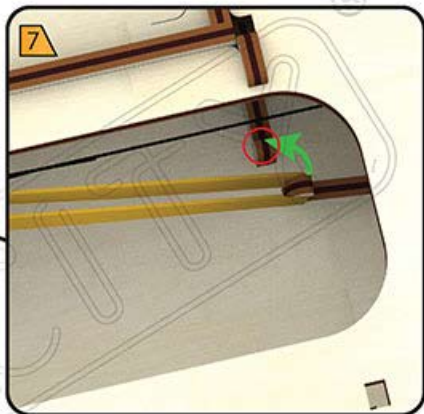
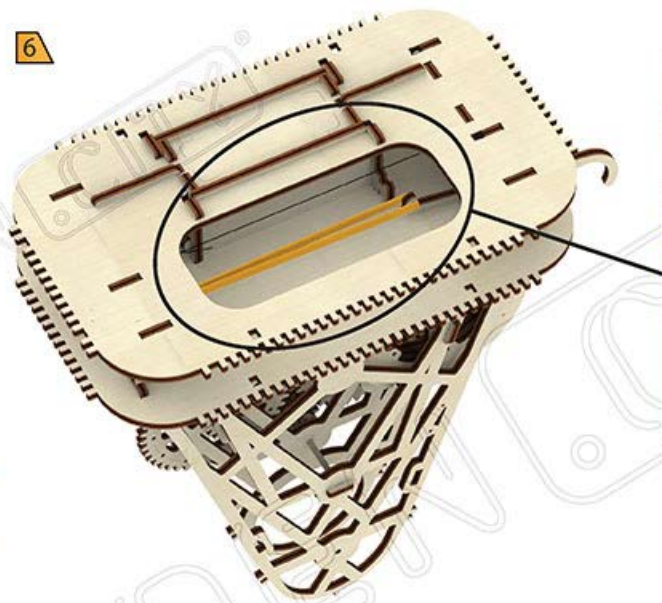

7

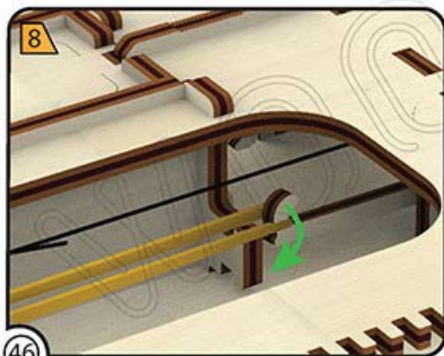

8

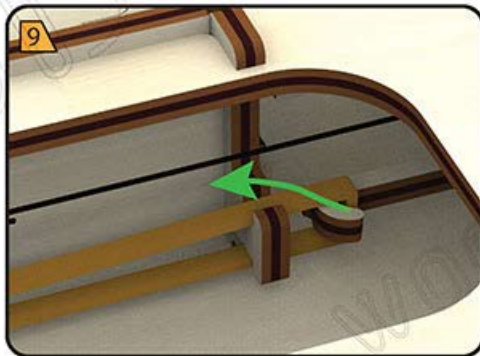

9

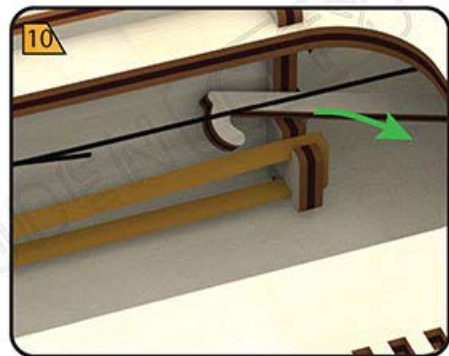

10

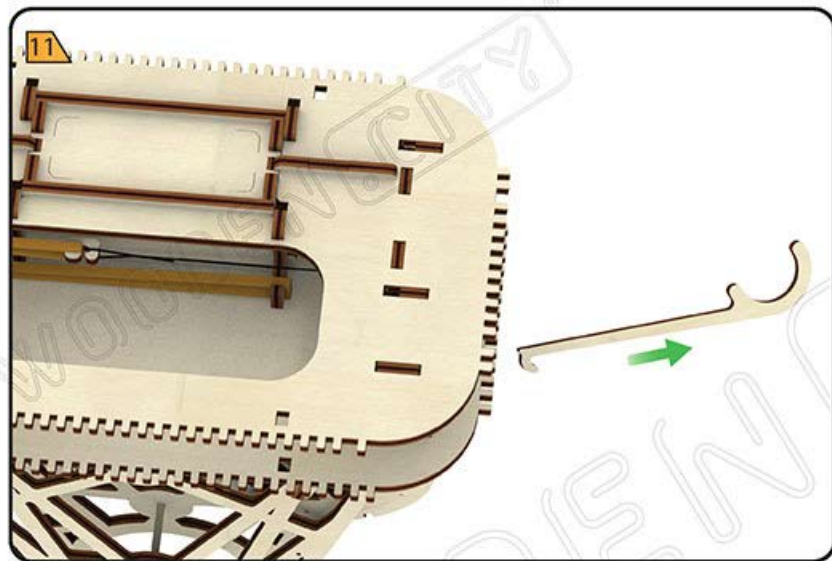

12

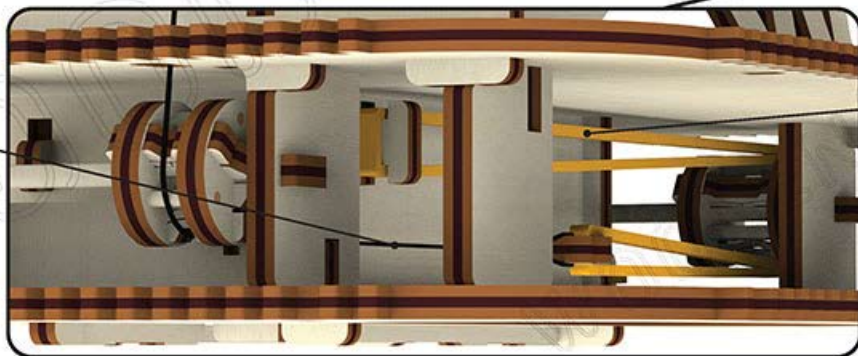
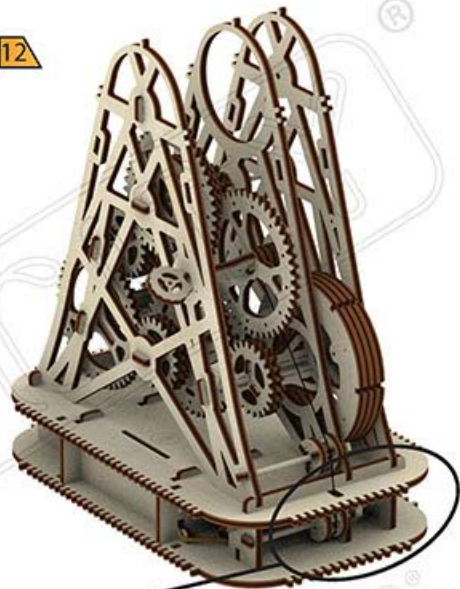

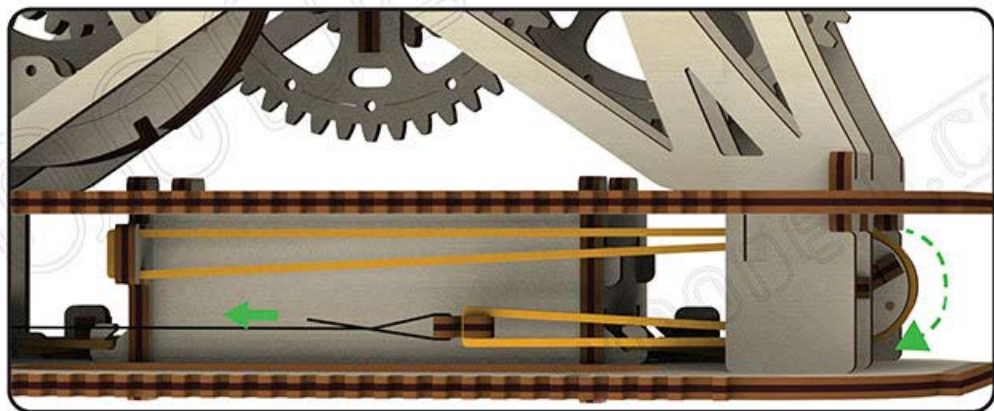
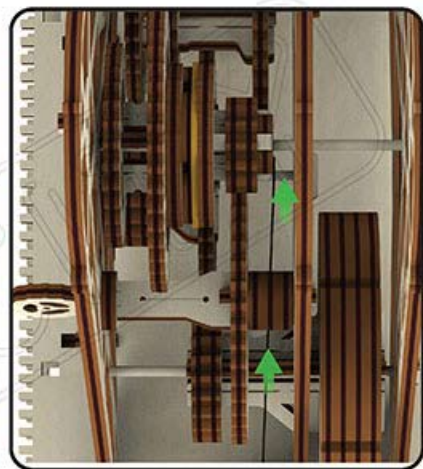
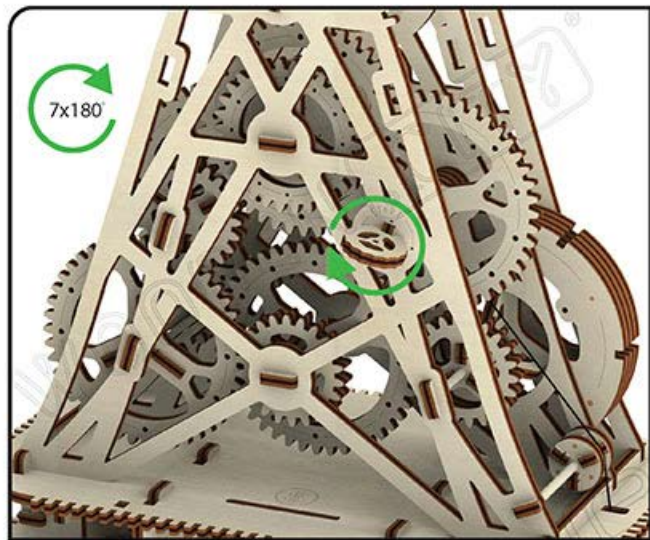

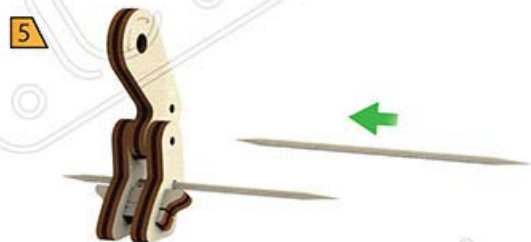
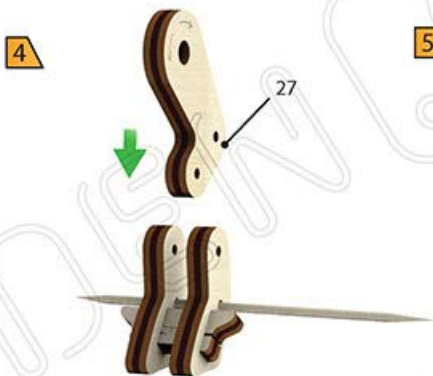
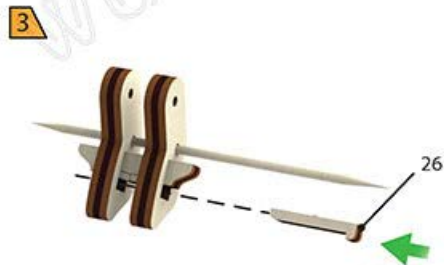
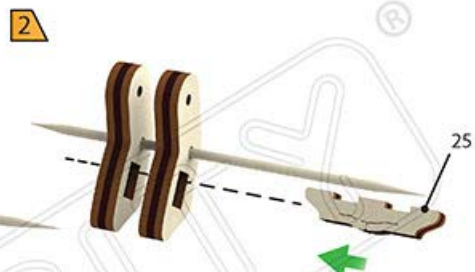
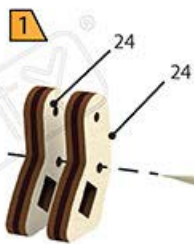

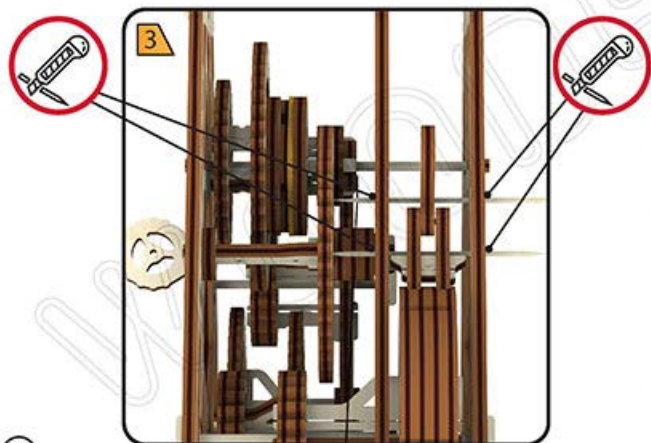
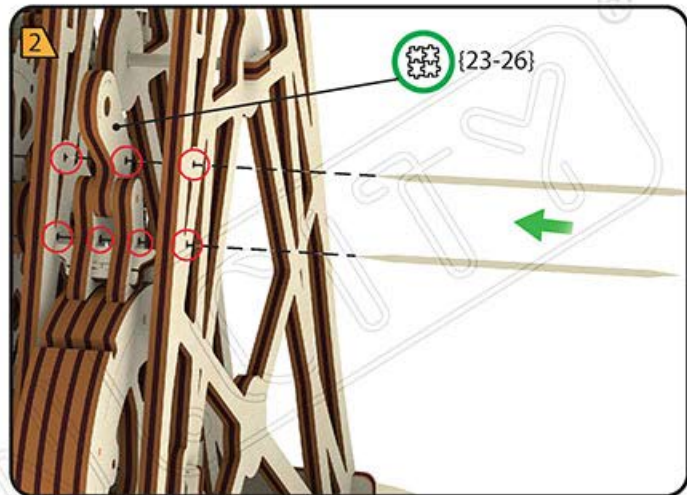
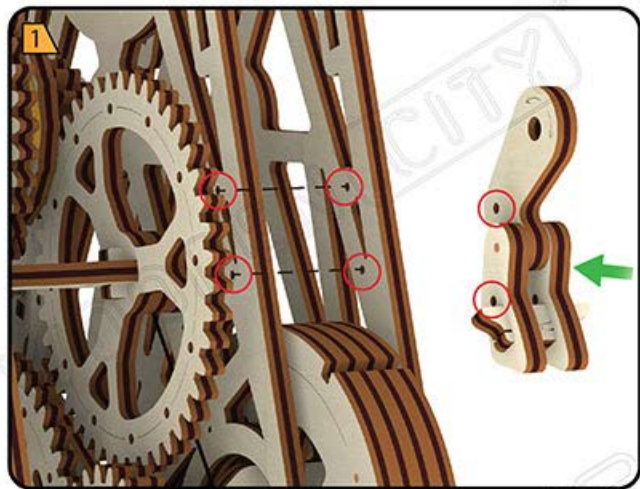

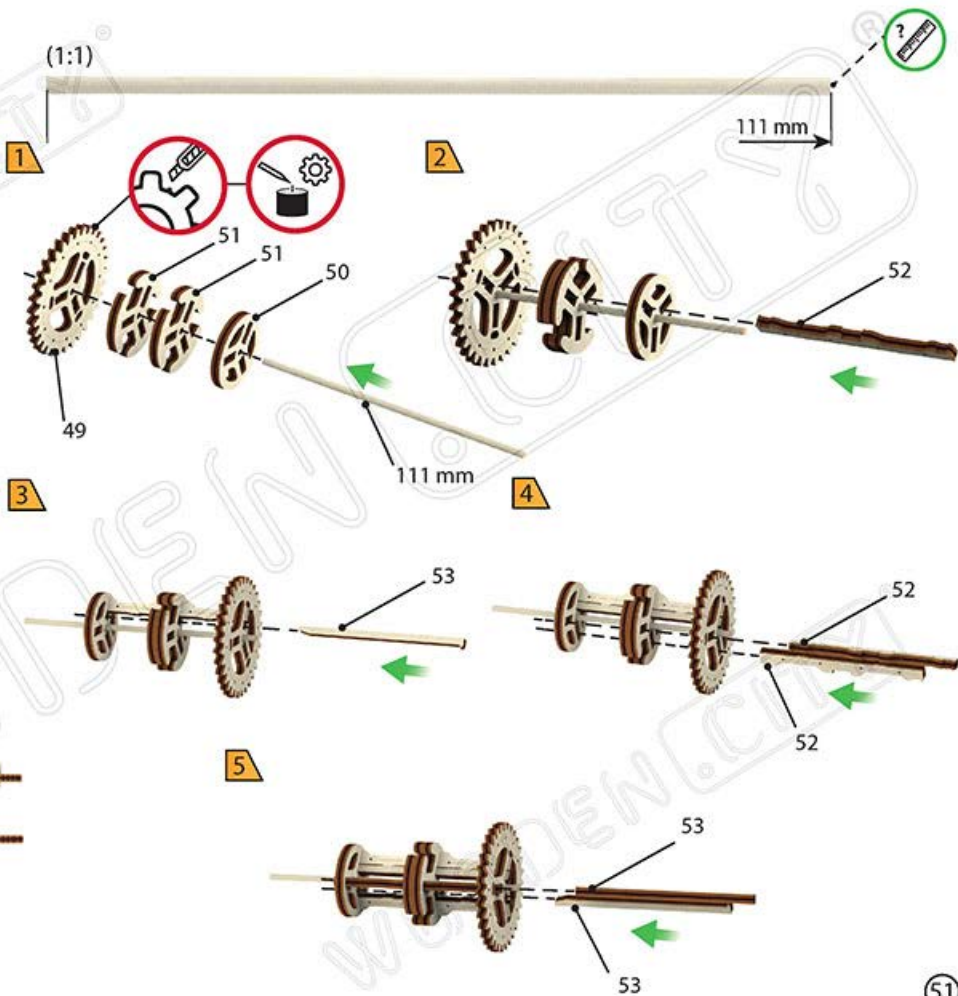
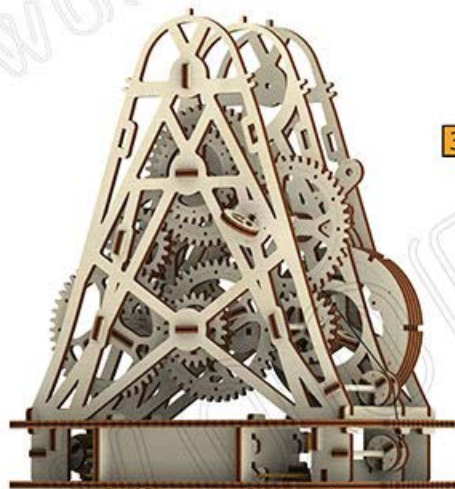
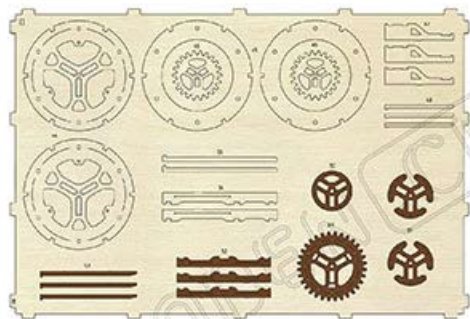

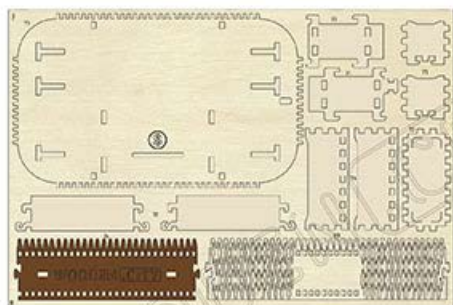

1

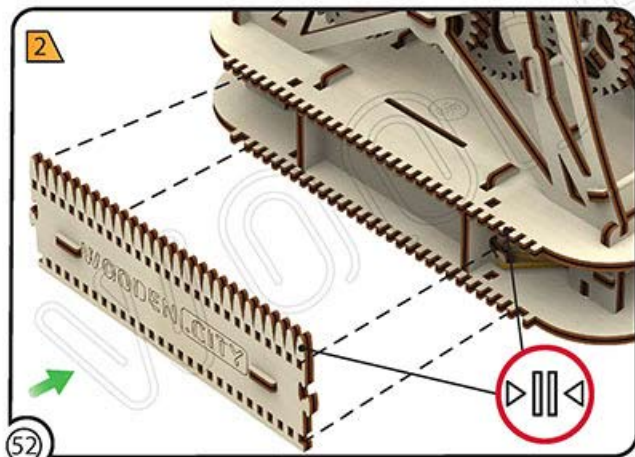
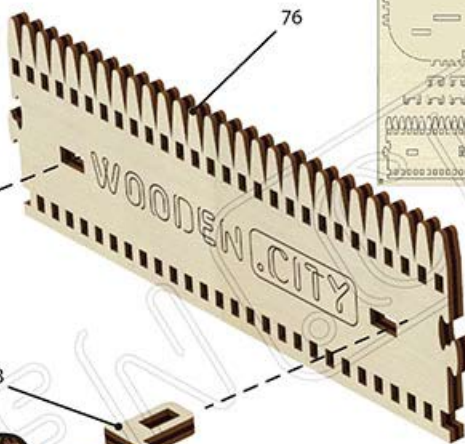
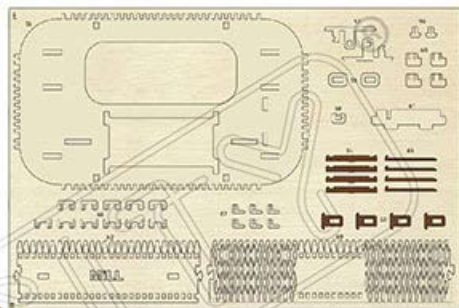

2

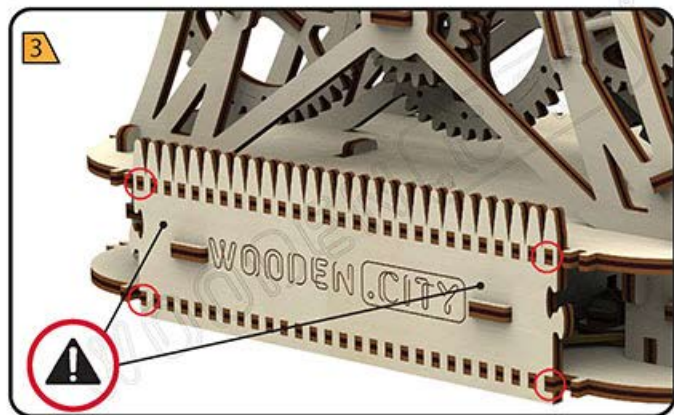

3



52

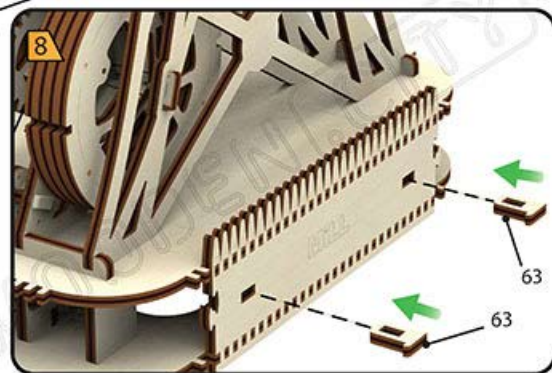
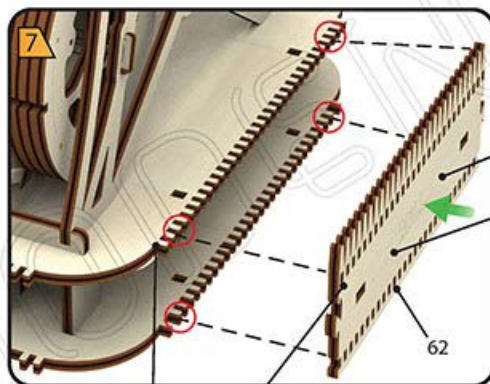
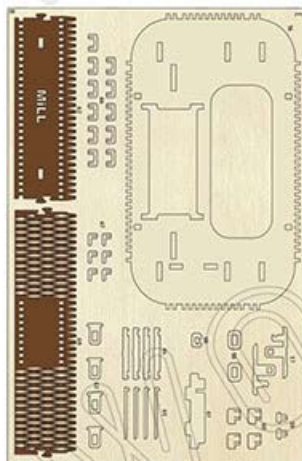
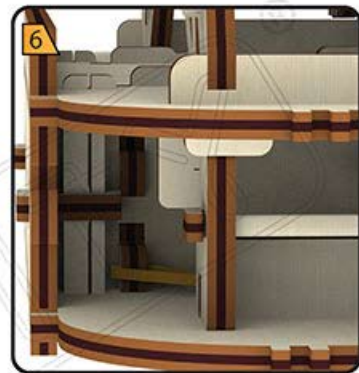
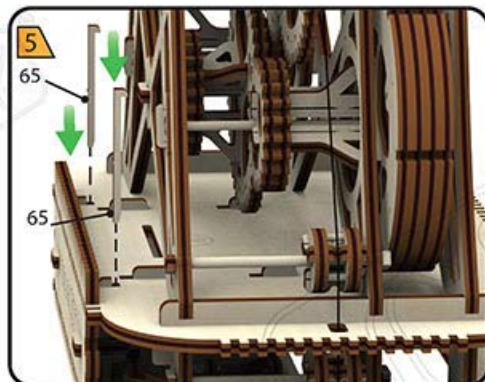
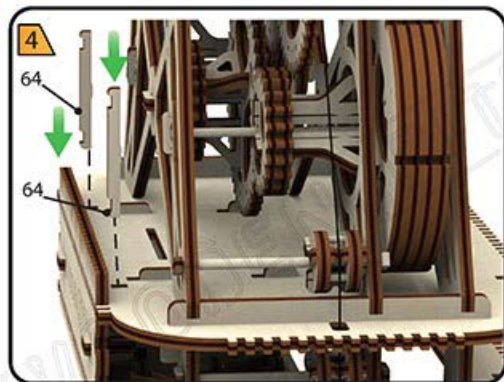

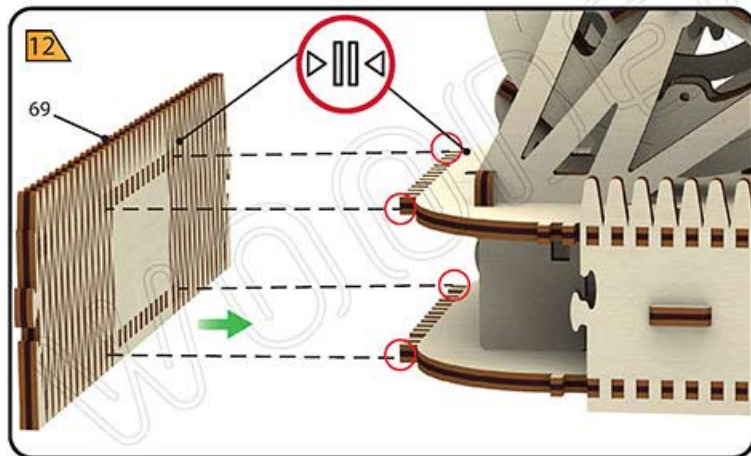
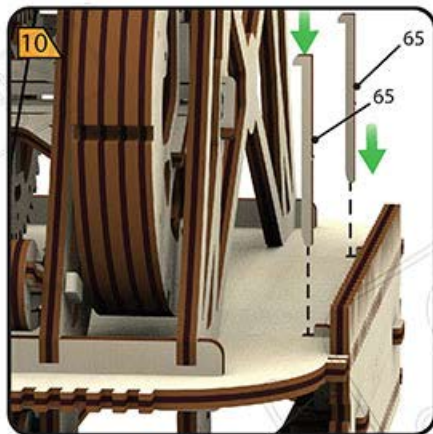
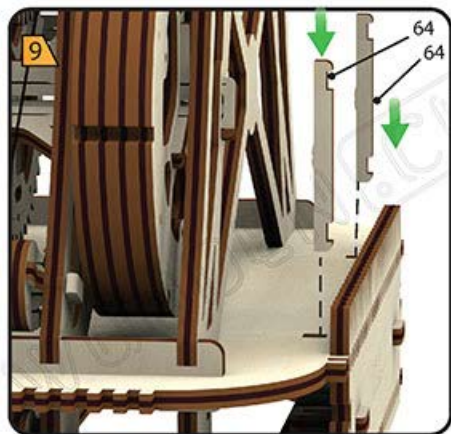

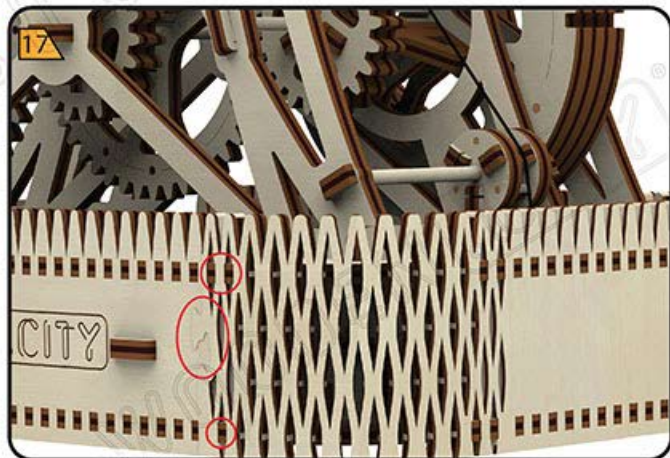
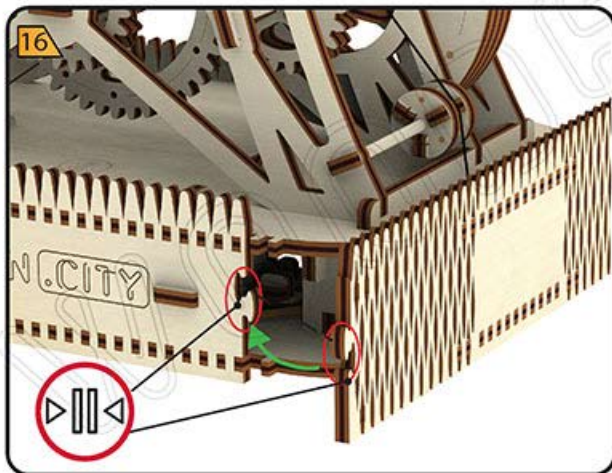
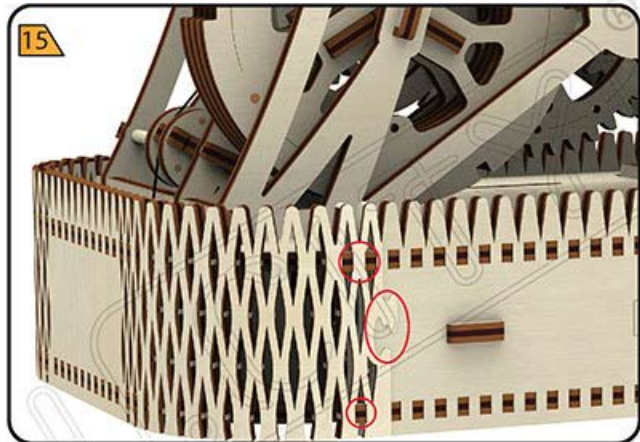
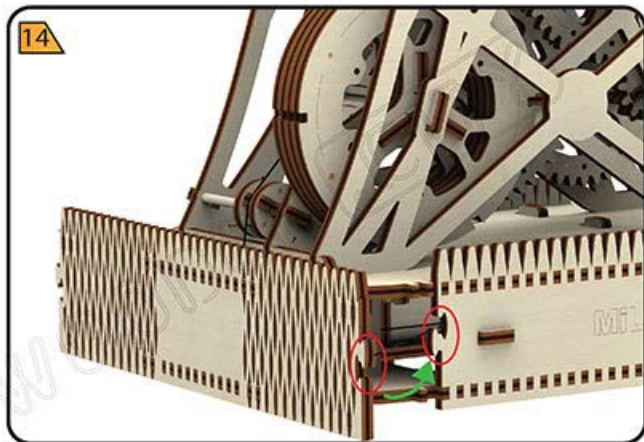

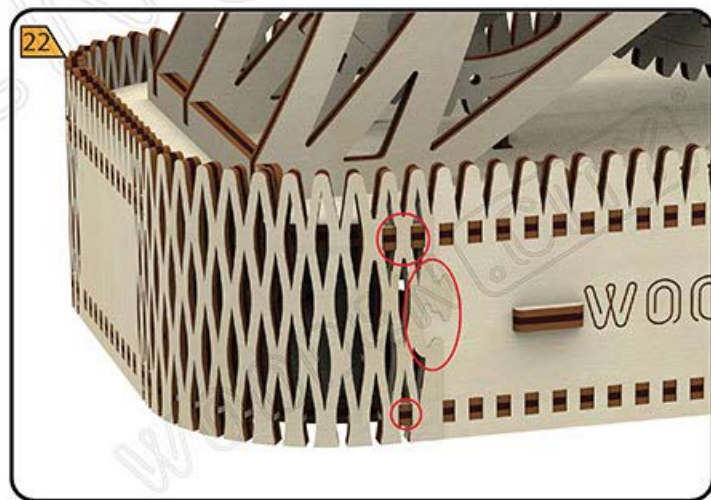
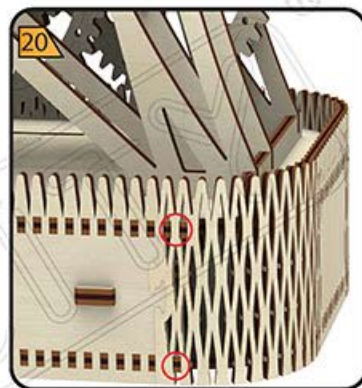
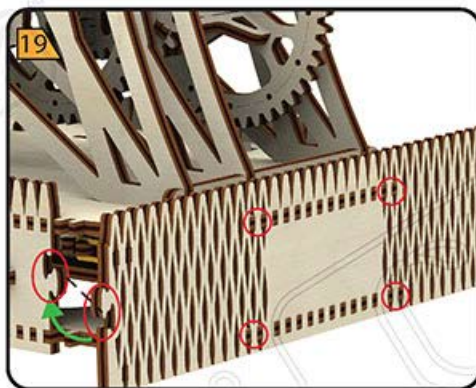
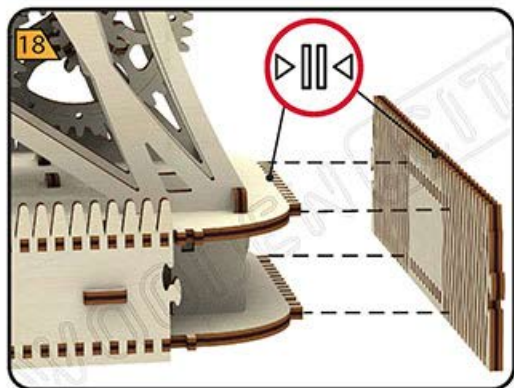

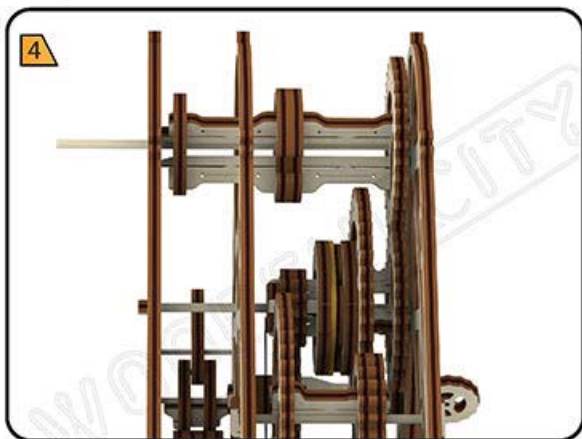
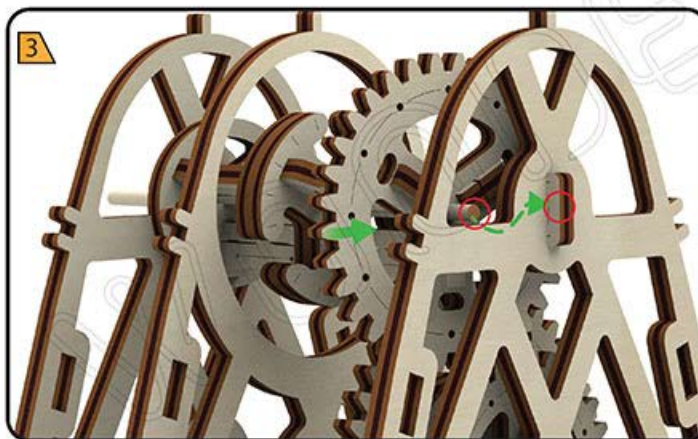
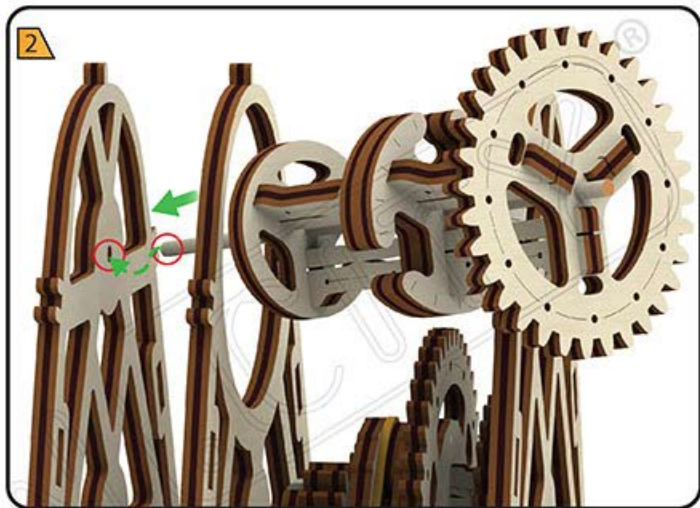
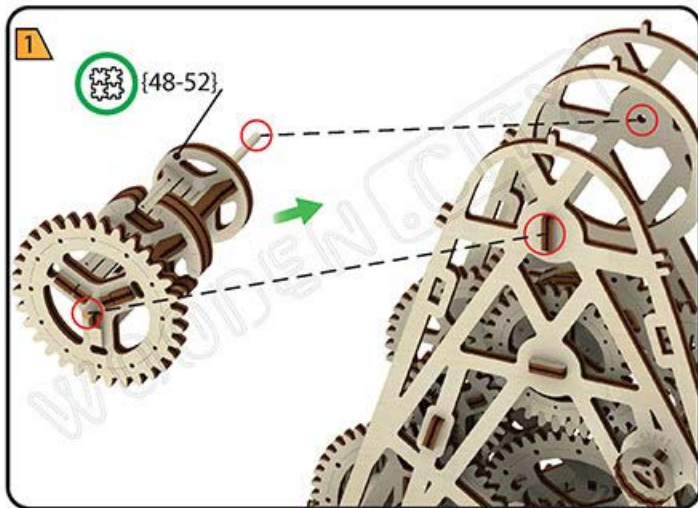

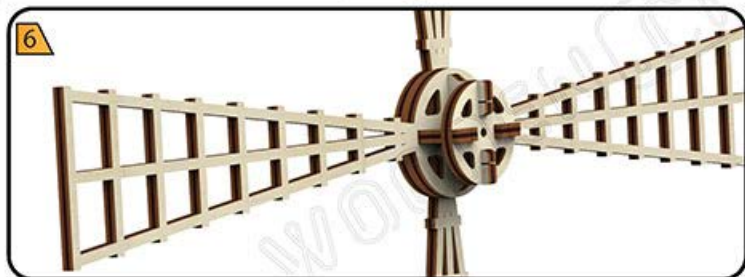
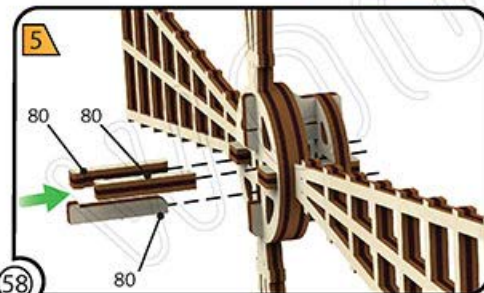
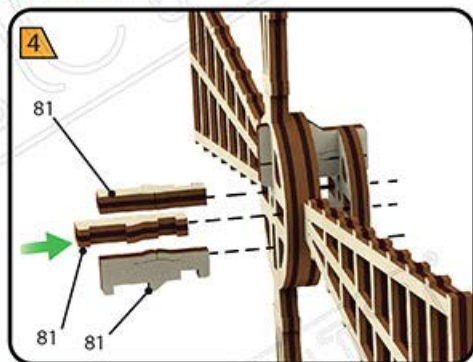
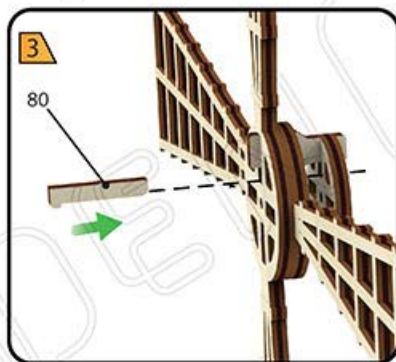
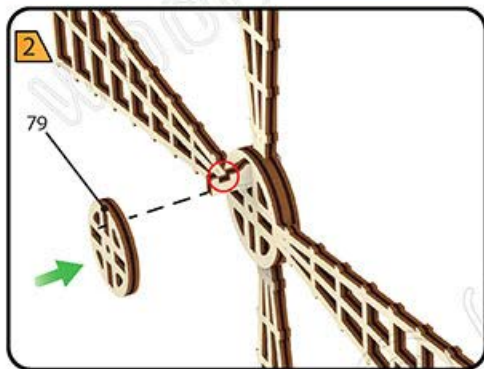
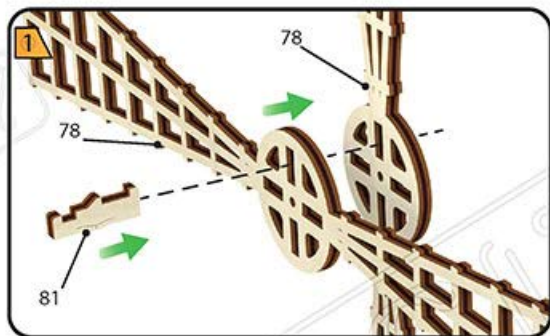
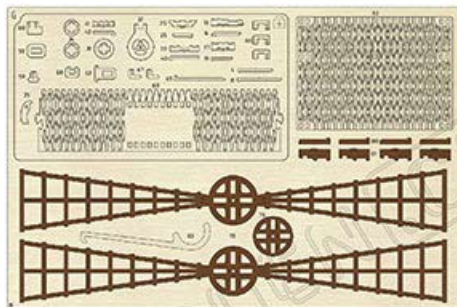

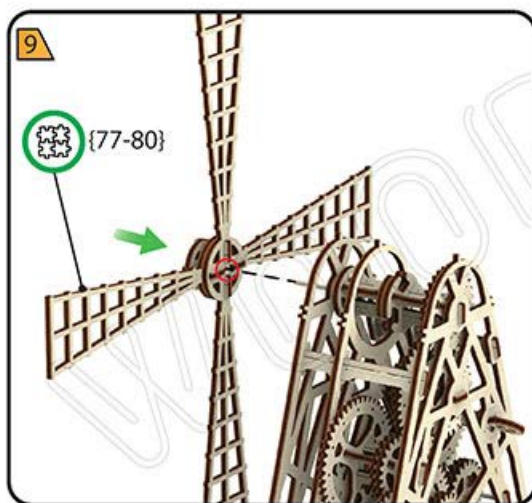
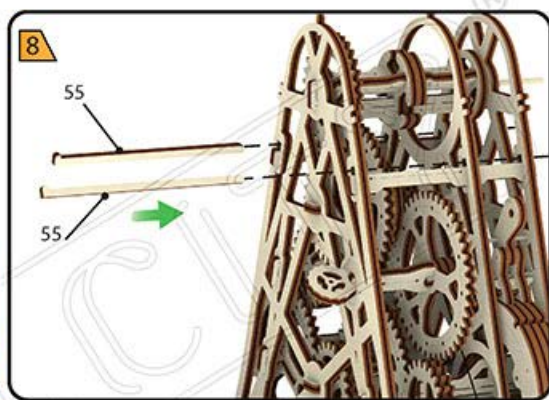
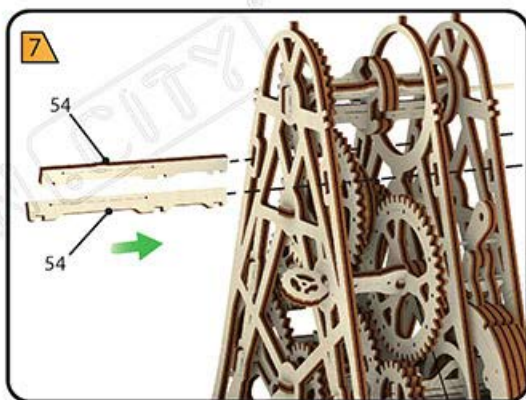

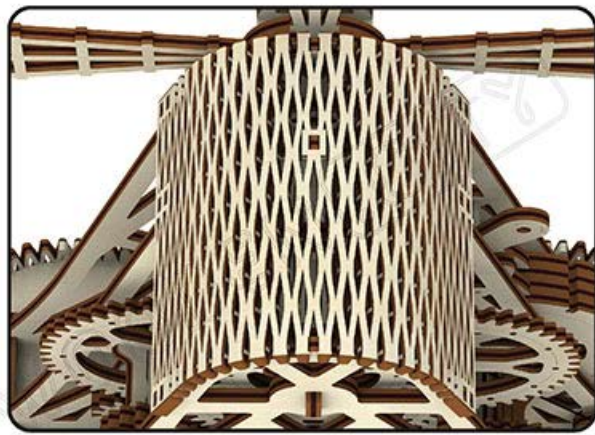
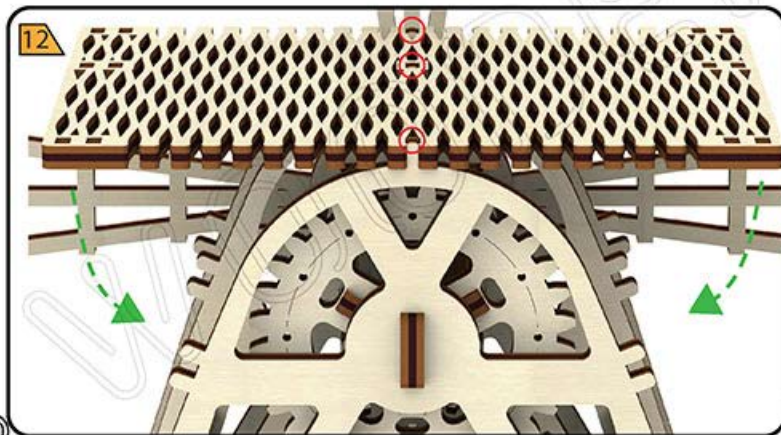
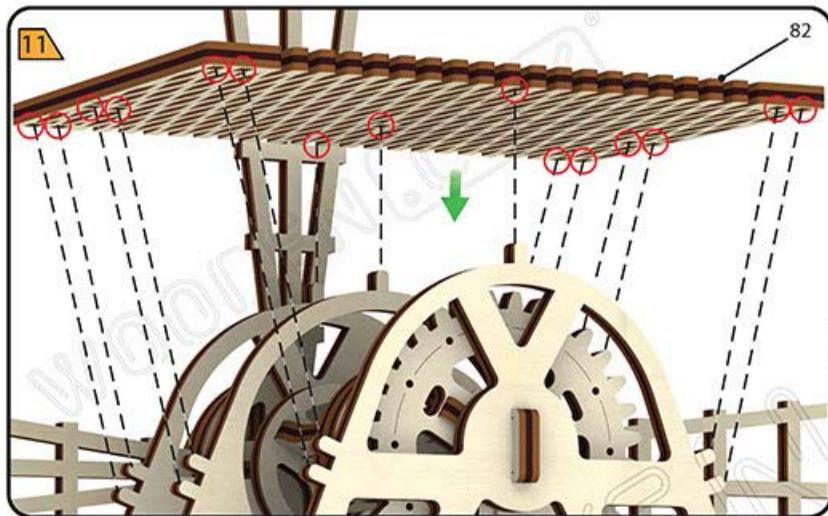

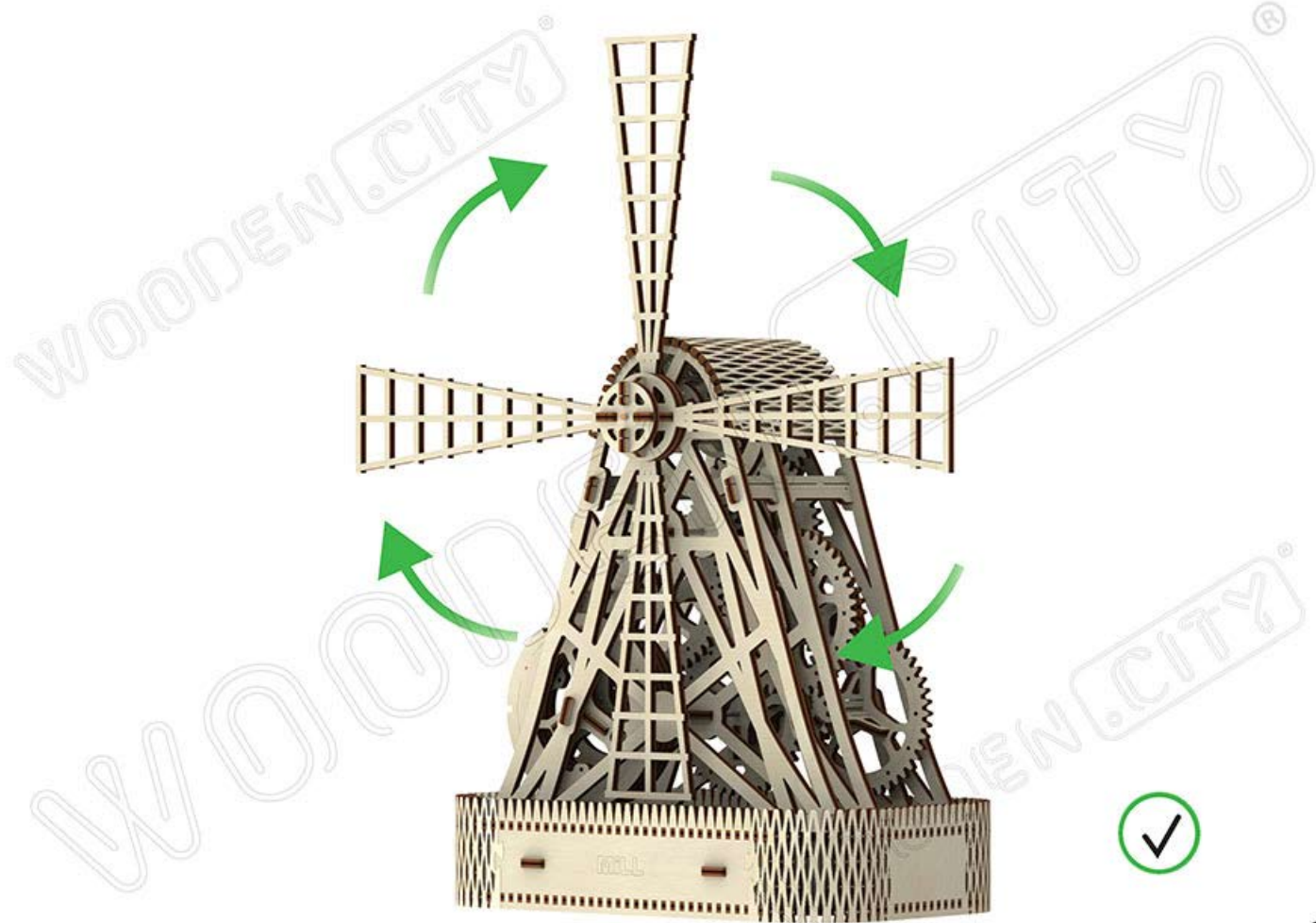

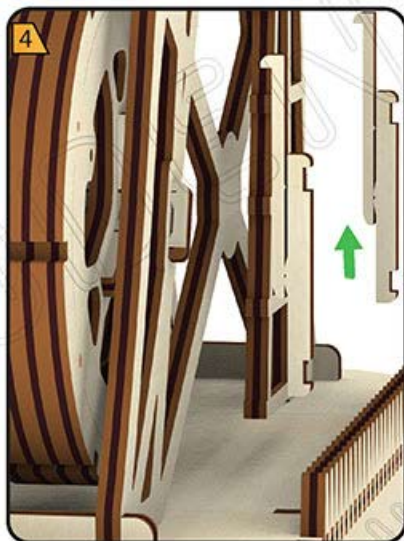
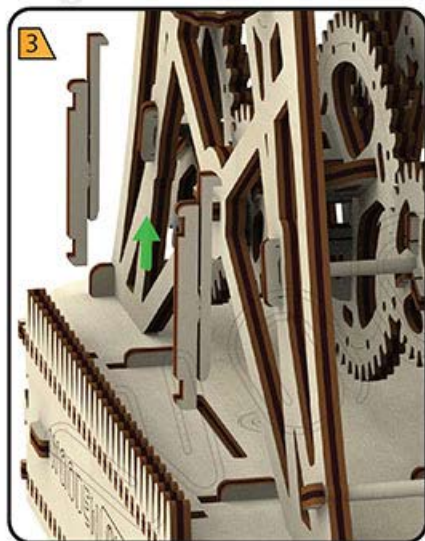
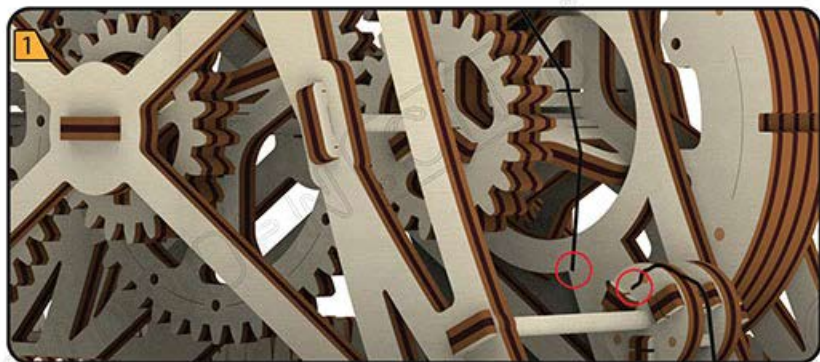

2

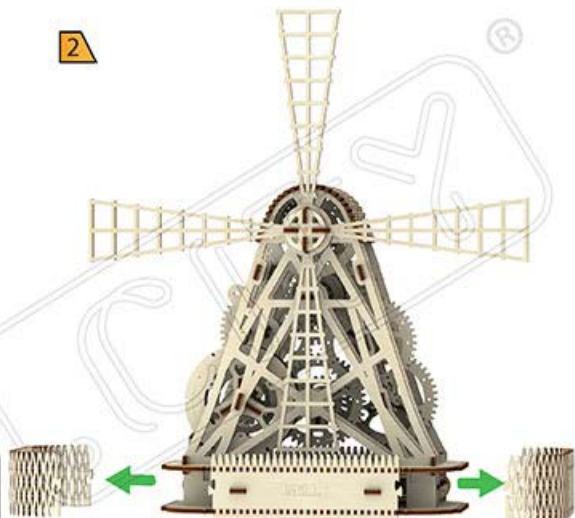

5

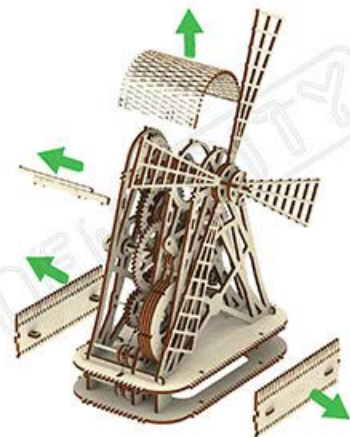

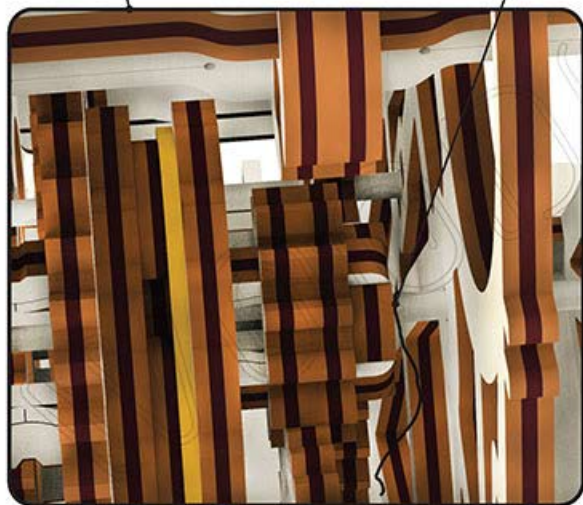
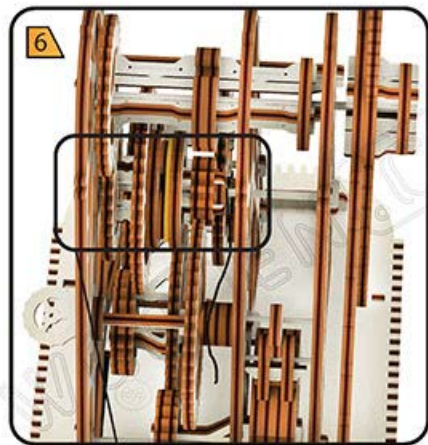



1

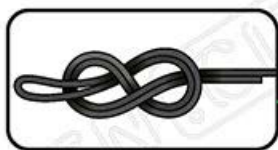

2

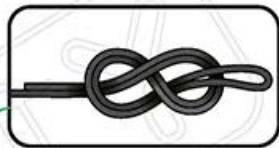
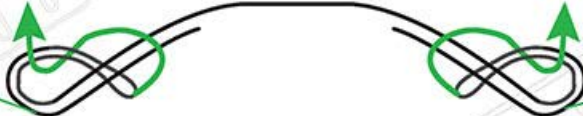

3



4



5

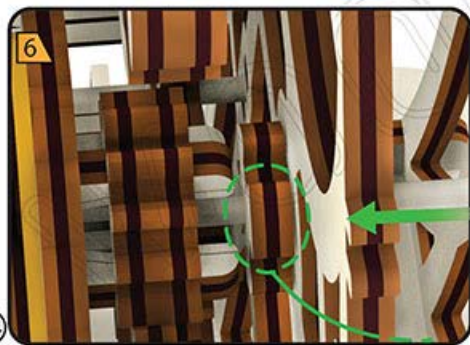
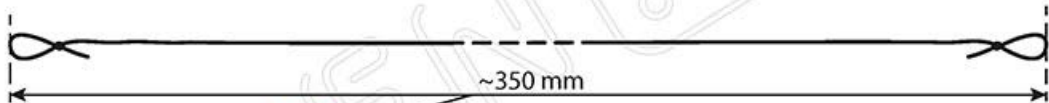

6



7

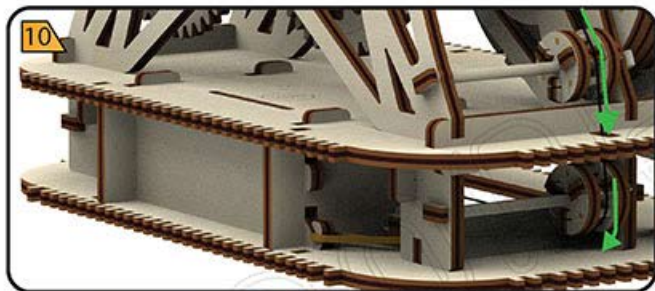
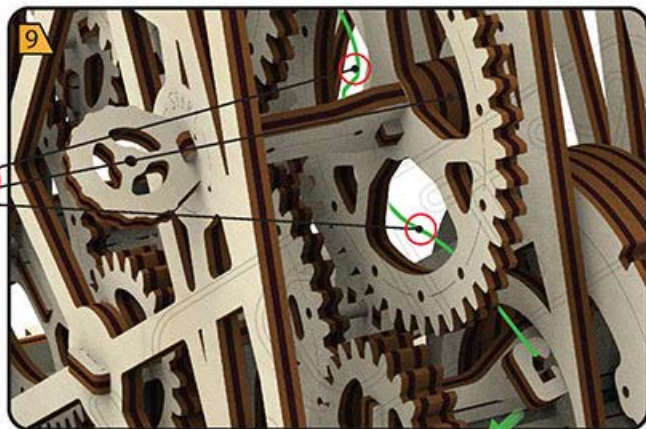
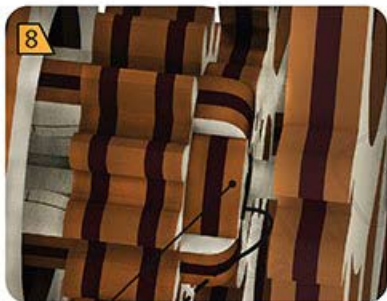

11

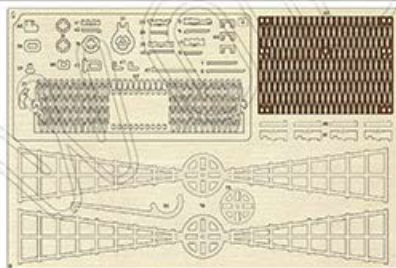

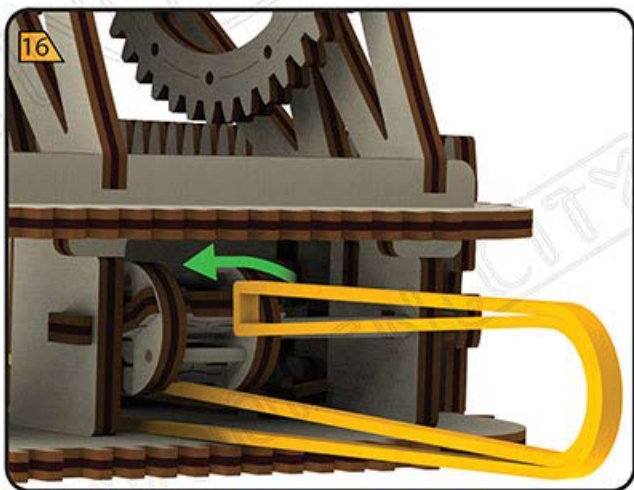
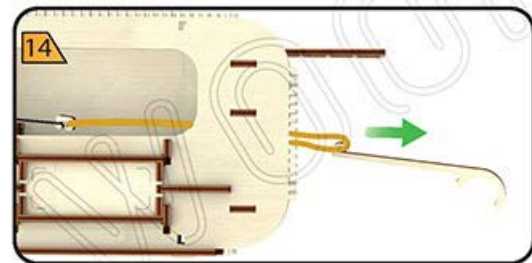
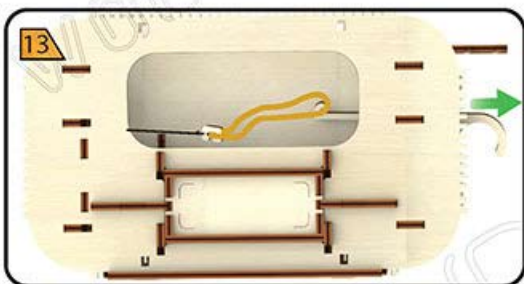
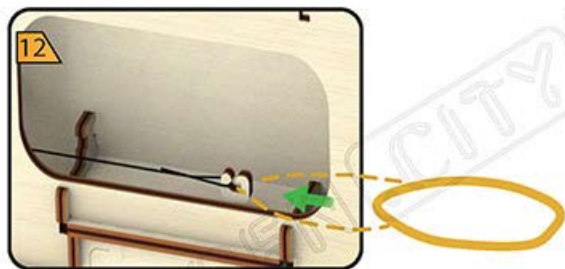

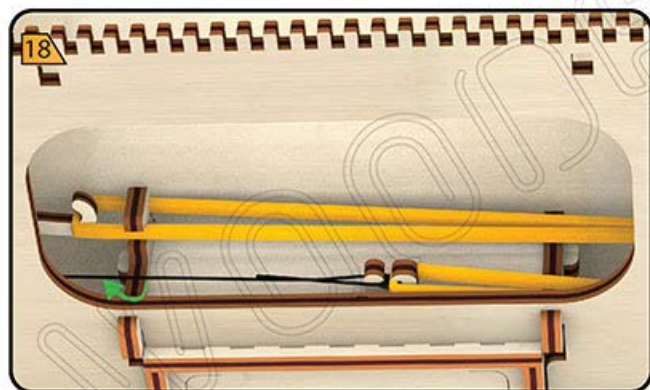
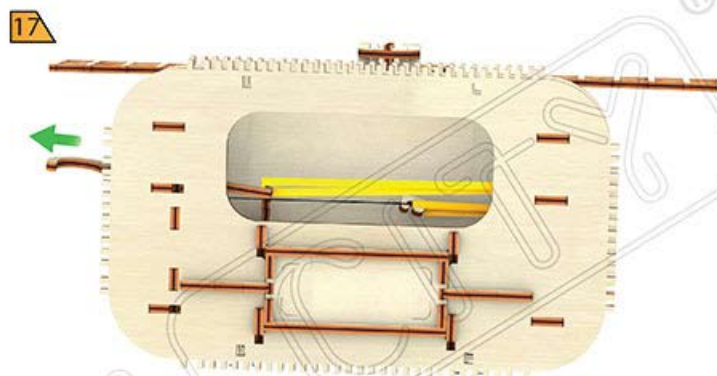
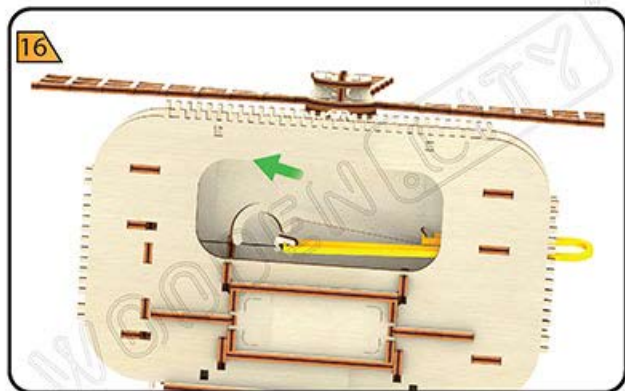

20



22

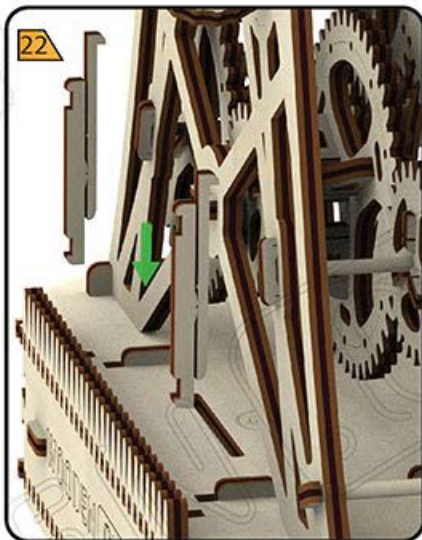

21

